



PRODUCT CATALOG

CONDITIONS OF SALE

RETURNS

Merchandise may not be returned without authorization. Approved return must be prepaid and are subject to a 15% restocking charge.

CONDITION OF SALE

The purchaser agrees to the following provisions:

- a) "The seller shall not be liable in damages for, nor deemed to be in default by reason of any failure or delay in shipment of all or any part of this order caused by war, fire, flood, strikes, lockouts, accidents, Act of God, Government order or requirement, interruption or shortage of materials or transportation facilities or other cause or circumstance, similar or otherwise, beyond its control. "
- b) "The seller may decline to deliver hereunder except for cash if at any time the company shall not be satisfied as to the customer's credit or responsibility."
- c) All prices are subject to change without notice.

WARRANTY

"The seller guarantees the said goods against original defects in material or workmanship for (one year) from the date of shipment provided as follows:

- a) the goods are used, operated and maintained in a competent and normal manner by the buyer and in conformity with the seller's instructions;
- b) the seller's liability under this warranty shall be limited to the replacement or repairs of any defective goods, free of charge to the buyer or, at the seller's option a refund of the purchase price less an adjusted charge for the service rendered by the defective goods;
- c) any expressed or implied warranty that the goods are adequate for any particular purpose is hereby negated;
- d) with respect to the goods not of the seller's own manufacture, this warranty shall apply only to the extent that the seller is able to enforce a claim for liability against the manufacturer thereof;
- e) the buyer shall give written notice to the seller forthwith after the discovery of any defect and thereafter shall make further use of the goods at his own risk;
- f) the seller shall not be liable for consequential damages arising out of the installation or use of the said goods;
- g) this warranty is given in lieu of all other warranties, implied, statutory, or otherwise."

CLAIMS

Our liability ceases when the goods are delivered to the Transportation Company and we hold receipt for them. Make your claim on the Transportation Companies for concealed as well as apparent damage, and advise us.

The information presented in this brochure is to be used as a general guide. This literature and other literature from Amiflex Inc. is to provide product options for further investigation by experienced, technically versed users. Due to the varietal nature of operating conditions and applications, the user is solely responsible for making the final selection of the product with full understanding that the performance and safety criteria of the application are met. The product specifications presented here are subject to change without notice.

TABLE OF CONTENTS

AIR.....	p. 19
CONTRACTORS 400 AIR.....	p. 19
JACKHAMMER - YELLOW AIR.....	p. 19
CONTRACTORS AIR.....	p. 20
SUPER SERVICE AIR.....	p. 21
STEELFLEX AIR.....	p. 22
OROFLEX AIR/WATER LAYFLAT DISCHARGE.....	p. 23
MONTANA.....	p. 23
SUPER GREEN ORS.....	p. 24
HOT AIR BLOWER HOSE.....	p. 24
GENERAL PURPOSE.....	p. 25
CLEAR REINFORCED PVC (FOOD QUALITY).....	p. 25
REINFORCED CLEAR PVC.....	p. 26
GENERAL PURPOSE.....	p. 27
EPDM GENERAL PURPOSE.....	p. 28
PREMIUM GENERAL PURPOSE - NON CONDUCTIVE.....	p. 29
ARCTIC SUPERFLEX GENERAL PURPOSE.....	p. 29
PUSH - ON BLACK.....	p. 30
PUSH - ON GREEN.....	p. 30
PUSH - ON BLUE.....	p. 30
PUSH - ON GREY.....	p. 31
PUSH - ON RED.....	p. 31
PUSH - ON YELLOW.....	p. 31
SELF-STORING AIR-URETHANE ASSEMBLY.....	p. 32
SELF-STORING AIR-NYLON.....	p. 33
WATER DISCHARGE.....	p. 35
BLUE LAYFLAT.....	p. 35
BROWN LAYFLAT.....	p. 36
GREEN LAYFLAT.....	p. 36
OROFLEX - PREMIUM RUBBER LAYFLAT.....	p. 37
DURAFLEX - RUBBER LAYFLAT.....	p. 38
CONTRACTORS WATER DISCHARGE - GARDEN HOSE.....	p. 38
CONTRACTORS WATER DISCHARGE.....	p. 39
PAPERMILL WASHDOWN.....	p. 39
CONTRACTORS PLUS WATER DISCHARGE.....	p. 40
PACKERS WASHDOWN.....	p. 40
HEAVY DUTY WATER DISCHARGE/LOW PRESSURE AIR.....	p. 41
SUPREME WHITE SANITARY.....	p. 41
HIGH PRESSURE CONTRACTORS WATER DISCHARGE.....	p. 42
WHITE SANITARY.....	p. 42
WATER SUCTION.....	p. 43
SATURN PVC WATER S&D.....	p. 43
SATURN WHITE PVC WATER SUCTION AND DISCHARGE HOSE.....	p. 44
SUPERFLEX PVC SUCTION.....	p. 45
EPDM WATER SUCTION.....	p. 45
HEAVY DUTY PVC WATER S&D.....	p. 46
RUBBER WATER S&D.....	p. 47
PETROLEUM.....	p. 49
TANK TRUCK.....	p. 49
SUPER BLACK 250.....	p. 50
LW ARCTIC SUPERFLEX 150 PETROLEUM.....	p. 50
HOT TAR & ASPHALT.....	p. 51
H.O.T OIL TANK TRUCK.....	p. 51
TANK TRUCK DROP 5000.....	p. 52
TANK TRUCK DROP 5000 BANDING SLEEVE.....	p. 52
TANK TRUCK DROP.....	p. 52
LW PETROLEUM TANK 150.....	p. 53

TABLE OF CONTENTS

PETROLEUM DISCHARGE.....	p. 53
PETROLEUM DISCHARGE 250.....	p. 54
URETHANE DUST&VAPOUR RECOVERY.....	p. 54
AGRICULTURAL FARM TANK 100 PSI.....	p. 55
SAE 100R4 OIL SUCTION HOSE.....	p. 55
STEAM.....	p. 57
STEAM TEXTILE.....	p. 57
STEAM 250 CHLOROBUTYL.....	p. 57
STEAM 250.....	p. 58
CHEMICAL.....	p. 59
EPR ACID DISCHARGE.....	p. 59
EPR ACID SUCTION.....	p. 59
HYPALON ACID DISCHARGE.....	p. 60
HYPALON ACID SUCTION.....	p. 60
VITON LINED DISCHARGE.....	p. 61
VITON LINED SUCTION.....	p. 61
CHEMICAL.....	p. 62
FLEXCHEM.....	p. 63
CHEMICAL RESISTANCE GUIDE.....	p. 1
MATERIAL HANDLING.....	p. 81
AZTEC SLURRY HOSE.....	p. 81
SPLIT FLANGE ALUMINUM FOR MATERIAL HANDLING HOSE.....	p. 81
SPLIT FLANGE DUCTILE FOR MATERIAL HANDLING HOSE.....	p. 82
GASKET FOR SPLIT FLANGE.....	p. 82
GUNITE.....	p. 82
BULKMASTER HARDWALL.....	p. 83
BULKMASTER SOFTWALL.....	p. 83
SANDBLAST.....	p. 84
TAN BULKMASTER.....	p. 85
CONCRETE PLACEMENT.....	p. 85
CONCRETE PLACEMENT WIRE REINFORCED.....	p. 86
INDUSTRIAL VACUUM HEAVY DUTY.....	p. 86
INDUSTRIAL VACUUM.....	p. 87
MATERIAL HANDLING POLYURETHANE AND PVC.....	p. 89
ARI SUCTION.....	p. 89
B - FLEX (FOOD GRADE).....	p. 90
B - FLEX (STATIC) (FOOD GRADE).....	p. 91
GREY PVC VACUUM.....	p. 92
NEPTUNE PVC SUCTION (FOOD GRADE).....	p. 93
NEPTUNE STATIC PVC SUCTION (FOOD GRADE).....	p. 94
PU VAC (FOOD QUALITY).....	p. 95
PU VAC LIGHT (FOOD QUALITY).....	p. 96
FOOD.....	p. 97
BACCO - PVC WINE SUCTION (FOOD QUALITY).....	p. 97
BREWERS & BEVERAGE DISCHARGE.....	p. 98
BREWERS SUCTION HOSE.....	p. 98
FOODFLEX PVC S&D (FOOD QUALITY).....	p. 99
CLEARFLEX PVC SUCTION & DISCHARGE (FOOD QUALITY).....	p. 99
FOODFLEX RUBBER SUCTION HOSE.....	p. 100
POLYETHYLENE TUBING.....	p. 100
CLEAR VINYL TUBING.....	p. 101
PURE GUM TUBING.....	p. 101
WIREVAC (FOOD QUALITY).....	p. 102
SUPER WIREVAC (FOOD QUALITY).....	p. 103
DUCTING.....	p. 105
TPR/RFH.....	p. 105
SUPER VAC-U-FLEX CUFF.....	p. 105

TABLE OF CONTENTS

SUPER VAC-U-FLEX.....	p. 106
NC1.....	p. 106
NC2.....	p. 107
VAC-U-LOK.....	p. 107
VAC-U-LOK CUFF.....	p. 108
SPIRATUBE - TDS & TDHS.....	p. 108
TPU VAC-U-FLEX.....	p. 109
TPE VAC-U-FLEX.....	p. 109
U1 FLEX FLYTE.....	p. 110
L1 FLEX FLYTE.....	p. 111
U9 FLEX FLYTE.....	p. 112
L9 FLEX FLYTE.....	p. 113
1PNEPW.....	p. 114
DUCT CONNECTOR.....	p. 114
DURATHANE LD/ "UFD".....	p. 115
DURATHANE MD/ "UFD.045".....	p. 116
SLP10 FLEXVENT.....	p. 117
AUTO TRUCK/MARINE.....	p. 119
MARINE EXHAUST HARDWALL.....	p. 119
MARINE EXHAUST SOFTWALL.....	p. 120
MARINE FUEL FILL - HARDWALL.....	p. 121
FUEL LINE.....	p. 121
SILICONE COOLANT HOSE.....	p. 122
SILICONE HEATER HOSE.....	p. 123
AUTO HEATER.....	p. 123
GARAGE EXHAUST HOSE.....	p. 124
FIRE.....	p. 125
ARMTX RUBBER COVERED FM APPROVED, ULC LISTED.....	p. 125
ARMTX HD RUBBER COVERED ULC LISTED.....	p. 125
DOUBLE JACKET 800 PSI.....	p. 126
DOUBLE JACKET 800 PSI HYPALON.....	p. 126
SINGLE JACKET RUBBER LINED 500 PSI.....	p. 127
SINGLE JACKET INDUSTRIAL MILL.....	p. 127
DURAFLO BLUE (RUBBER COVERED STANDPIPE WASHDOWN).....	p. 128
RACK HOSE.....	p. 128
OTHER HOSE.....	p. 129
PRESSURE WASHER.....	p. 129
PAINT SPRAY.....	p. 129
PAINT SPRAY NYLON.....	p. 130
WELDING.....	p. 131
SINGLE LINE WELDING TYPE S GRADE R.....	p. 131
TWIN WELDING TYPE VD GRADE R ASSEMBLY.....	p. 131
SINGLE LINE WELDING TYPE S GRADE RM.....	p. 132
TWIN WELDING TYPE VD GRADE R.....	p. 132
TWIN WELDING TYPE VD GRADE RM.....	p. 133
CAM & GROOVE PART A.....	p. 135
PART A ALUMINUM.....	p. 135
PART A STAINLESS 316.....	p. 135
PART A BRASS.....	p. 136
PART A DUCTILE IRON.....	p. 136
PART A POLY.....	p. 136
PART A NYLON GLASS.....	p. 137
PART A ALUMINUM BSP THREAD.....	p. 137
PART A STAINLESS 316 BSP THREAD.....	p. 137
PART A ALUMINUM NPS THREAD.....	p. 138
PART A SPOOL ADAPTER ALUMINUM.....	p. 138
PART A SPOOL ADAPTER BRASS.....	p. 138

TABLE OF CONTENTS

PART A SPOOL ADAPTER STAINLESS 316.....	p. 139
PART A REDUCER ADAPTER FEMALE NPT ALUMINUM.....	p. 139
PART A NYLON REDUCER ADAPTER FEMALE NPT.....	p. 139
PART A POLY REDUCER ADAPTER FEMALE NPT.....	p. 140
PART A POLY ELBOW 90 DEGREE.....	p. 140
PART A ALUMINUM FLANGED CAMLOCK ADAPTER.....	p. 140
CAM & GROOVE PART B.....	p. 141
PART B ALUMINUM.....	p. 141
PART B DUCTILE IRON.....	p. 141
PART B STAINLESS 316.....	p. 142
PART B ALUMINUM WITH STAINLESS HANDLES.....	p. 142
PART B BRASS.....	p. 143
PART B POLY.....	p. 143
PART B NYLON GLASS.....	p. 144
PART B ALUMINUM BSP THREAD.....	p. 144
PART B STAINLESS 316 BSP THREAD.....	p. 144
PART B NYLON REDUCER COUPLER MALE NPT.....	p. 145
PART B POLY REDUCER COUPLER MALE NPT.....	p. 145
PART B REDUCER COUPLER MALE NPT ALUMINUM.....	p. 145
PART B ALUMINUM QUICKKLOK.....	p. 146
PART B STAINLESS QUICKKLOK.....	p. 146
PART B BRASS QUICKKLOK.....	p. 146
CAM & GROOVE PART C.....	p. 147
PART C ALUMINUM.....	p. 147
PART C DUCTILE IRON.....	p. 147
PART C STAINLESS 316.....	p. 148
PART C BRASS.....	p. 148
PART C ALUMINUM WITH STAINLESS HANDLES.....	p. 149
PART C POLY.....	p. 149
PART C NYLON GLASS.....	p. 150
PART C ALUMINUM REDUCER COUPLER SHANK.....	p. 150
PART C NYLON REDUCER COUPLER SHANK.....	p. 150
PART C POLY REDUCER COUPLER SHANK.....	p. 151
PART C POLY ELBOW 90 DEGREE.....	p. 151
PART C ALUMINUM 90 DEGREE.....	p. 151
PART C SHANK ALUMINUM VAP REC CAM W PROBE.....	p. 152
PART C ALUMINUM QUICKKLOK.....	p. 152
PART C STAINLESS 316 QUICKKLOK.....	p. 152
PART C BRASS QUICKKLOK.....	p. 153
CAM AND GROOVE COUPLINGS FOR LAYFLAT HOSE.....	p. 155
CAM AND GROOVE COUPLINGS FOR LAYFLAT HOSE.....	p. 155
CAM & GROOVE PART D.....	p. 157
PART D ALUMINUM.....	p. 157
PART D DUCTILE IRON.....	p. 157
PART D STAINLESS 316.....	p. 158
PART D BRASS.....	p. 158
PART D ALUMINUM WITH STAINLESS HANDLES.....	p. 159
PART D POLY.....	p. 159
PART D NYLON GLASS.....	p. 160
PART D ALUMINUM BSP THREAD.....	p. 160
PART D STAINLESS 316 BSP THREAD.....	p. 161
PART D REDUCER COUPLER ADAPTER ALUMINUM.....	p. 161
PART D REDUCER COUPLER ADAPTER STAINLESS 316.....	p. 162
PART D REDUCER COUPLER ADAPTER BRASS.....	p. 162
PART D REDUCER COUPLER FEMALE NPT ALUMINUM.....	p. 162
PART D SPOOL COUPLER ALUMINUM.....	p. 163
PART D SPOOL COUPLER STAINLESS 316.....	p. 163
PART D POLY REDUCER COUPLER FEMALE NPT.....	p. 163

TABLE OF CONTENTS

PART D NYLON REDUCER COUPLER FEMALE NPT.....	p. 164
PART D 90 DEG STAINLESS ELBOW.....	p. 164
PART D POLY ELBOW 90 DEGREE.....	p. 164
PART D ALUMINUM QUICKKLOK.....	p. 165
PART D STAINLESS 316 QUICKKLOK.....	p. 165
PART D BRASS QUICKKLOK.....	p. 165
CAM & GROOVE PART E.....	p. 167
PART E ALUMINUM.....	p. 167
PART E STAINLESS 316.....	p. 167
PART E BRASS.....	p. 168
PART E DUCTILE IRON.....	p. 168
PART E POLY.....	p. 168
PART E NYLON GLASS.....	p. 169
PART E SHANK ALUMINUM CAMLOCK.....	p. 169
PART E NYLON REDUCER ADAPTER SHANK.....	p. 169
PART E POLY REDUCER ADAPTER SHANK.....	p. 169
CAM & GROOVE PART F.....	p. 171
PART F ALUMINUM.....	p. 171
PART F STAINLESS 316.....	p. 171
PART F BRASS.....	p. 172
PART F DUCTILE IRON.....	p. 172
PART F POLY.....	p. 172
PART F NYLON GLASS.....	p. 173
PART F ALUMINUM BSP THREAD.....	p. 173
PART F STAINLESS 316 BSP THREAD.....	p. 173
PART F REDUCER ADAPTER MALE NPT ALUMINUM.....	p. 174
PART F NYLON REDUCER ADAPTER MALE NPT.....	p. 174
PART F POLY REDUCER ADAPTER MALE NPT.....	p. 174
PART F POLY ELBOW 90 DEGREE.....	p. 174
CAM & GROOVE DUST CAP.....	p. 175
DUST CAP ALUMINUM.....	p. 175
DUST CAP DUCTILE IRON.....	p. 175
DUST CAP STAINLESS 316.....	p. 176
DUST CAP BRASS.....	p. 176
DUST CAP ALUMINUM WITH STAINLESS HANDLES.....	p. 177
DUST CAP POLY.....	p. 177
DUST CAP NYLON GLASS.....	p. 178
DUST CAP ALUMINUM LOCKING.....	p. 178
DUST CAP LOCKING STAINLESS 316.....	p. 179
DUST CAP ALUMINUM QUICKKLOK.....	p. 179
DUST CAP STAINLESS 316 QUICKKLOK.....	p. 179
DUST CAP BRASS QUICKKLOK.....	p. 180
DUST CAP ALUMINUM + CHAIN.....	p. 180
CAM & GROOVE DUST PLUG.....	p. 181
DUST PLUG ALUMINUM.....	p. 181
DUST PLUG STAINLESS 316.....	p. 181
DUST PLUG DUCTILE IRON.....	p. 182
DUST PLUG BRASS.....	p. 182
DUST PLUG NYLON GLASS.....	p. 182
DUST PLUG POLY.....	p. 183
CAM & GROOVE PARTS.....	p. 185
HANDLE+PIN+RING BRASS.....	p. 185
HANDLE+PIN+RING STAINLESS.....	p. 185
LOCKING HANDLE BRASS FOR CAMLOCK.....	p. 186
LOCKING HANDLE STAINLESS FOR CAMLOCK.....	p. 186
QUICKKLOK HANDLE FOR ALUMINUM, BRASS AND STAINLESS.....	p. 186
H PIECE FOR SELFLOCK HANDLE.....	p. 187

TABLE OF CONTENTS

LOCKING SAFETY CLIP FOR CAMS.....	p. 187
CAMLOCK GASKET EPDM.....	p. 188
CAMLOCK GASKET NBR.....	p. 188
CAMLOCK GASKET VITON.....	p. 189
CAMLOCK GASKET WHITE NBR.....	p. 189
TEFLON ENCAPSULATED SILICONE GASKET.....	p. 189
TEFLON ENCAPSULATED VITON GASKET.....	p. 190
TEFLON ENVELOPED BUNA OR VITON CAM GASKET.....	p. 190
TEFLON ENVELOPED NEOPRENE CAM GASKET.....	p. 190
GARDEN HOSE CAM AND GROOVE.....	p. 191
GARDEN HOSE CAM AND GROOVE.....	p. 191
COMBINATION NIPPLE.....	p. 193
COMBINATION NIPPLE PLAIN NPT.....	p. 193
COMBINATION NIPPLE PLATED.....	p. 194
COMBINATION NIPPLE 304 STAINLESS.....	p. 194
COMBINATION NIPPLE 316 STAINLESS.....	p. 195
COMBINATION NIPPLE ALUMINUM.....	p. 195
COMBINATION NIPPLE BRASS.....	p. 195
COMBINATION NIPPLE POLY.....	p. 196
COMBINATION NIPPLE PLAIN VICTAULIC GROOVED.....	p. 196
COMBINATION NIPPLE PLATED VICTAULIC GROOVED.....	p. 196
COMBINATION NIPPLE 304 STAINLESS VICTAULIC GROOVED.....	p. 197
COMBINATION NIPPLE 316 STAINLESS VICTAULIC GROOVED.....	p. 197
COMBINATION NIPPLE PLATED LONG NPT.....	p. 197
COMBINATION NIPPLE PLATED LONG VICTAULIC GROOVED.....	p. 197
MENDER PLAIN.....	p. 198
MENDER PLATED.....	p. 198
MENDER 304 STAINLESS.....	p. 199
REDUCER PLATED NPT.....	p. 199
EXPANDER PLATED NPT.....	p. 199
SHORT SHANK.....	p. 201
SHORT SHANK ALUMINUM FEMALE NPS.....	p. 201
SHORT SHANK ALUMINUM MALE NPS.....	p. 201
SHORT SHANK ALUMINUM SET NPS.....	p. 201
SHORT SHANK BRASS FEMALE GHT.....	p. 202
SHORT SHANK BRASS MALE GHT.....	p. 202
SHORT SHANK BRASS GHT SET.....	p. 202
SHORT SHANK BRASS FEMALE NPS.....	p. 202
SHORT SHANK BRASS MALE NPS.....	p. 203
SHORT SHANK BRASS SET.....	p. 203
SHORT SHANK BRASS FEMALE IPT/ NPS.....	p. 203
SHORT SHANK BRASS MALE IPT/ NPS.....	p. 203
SHORT SHANK BRASS FEMALE IPT/ NPS.....	p. 204
SHORT SHANK BRASS IPT/ NPS SET.....	p. 204
SHORT SHANK BRASS MALE NPS.....	p. 204
SHORT SHANK BRASS NPS SET.....	p. 204
SHORT SHANK MALLEABLE FEMALE NPS.....	p. 205
SHORT SHANK MALLEABLE MALE NPS.....	p. 205
SHORT SHANK MALLEABLE SET NPS.....	p. 205
SHORT SHANK GASKET.....	p. 206
LONG SHANK.....	p. 207
LONG SHANK BRASS FEM GHT.....	p. 207
LONG SHANK BRASS FEMALE IPT/NPS.....	p. 207
LONG SHANK BRASS MALE GHT.....	p. 207
LONG SHANK BRASS MALE IPT/NPS.....	p. 208
LONG SHANK BRASS SET GHT.....	p. 208
LONG SHANK BRASS SET IPT/NPS.....	p. 208
LONG SHANK GASKET.....	p. 208

TABLE OF CONTENTS

LONG+SHORT SHANK GASKET.....	p. 209
IRRIGATION COUPLINGS.....	p. 211
IRRIGATION COUPLING FEMALE SHANK WITH GASKET.....	p. 211
IRRIGATION COUPLING MALE SHANK.....	p. 211
IRRIGATION COUPLING LOCKING LEVER.....	p. 211
IRRIGATION COUPLING MALE SHANK WITH LOCKING LEVER.....	p. 211
IRRIGATION COUPLING SET.....	p. 212
IRRIGATION COUPLING FEMALE WITH GASKET X MALE NPT.....	p. 212
IRRIGATION COUPLING MALE X MALE NPT.....	p. 212
IRRIGATION COUPLING MALE LOCKING X MALE NPT.....	p. 212
IRRIGATION COUPLING SAFETY CLIP.....	p. 213
IRRIGATION COUPLING GASKET.....	p. 213
DOUBLE BOLT CLAMP.....	p. 215
DOUBLE BOLT CLAMP.....	p. 215
HEAVY DUTY CLAMP.....	p. 216
GEAR CLAMP.....	p. 217
GEAR CLAMPS.....	p. 217
GEAR CLAMP MICRO.....	p. 218
TRIDON GEAR CLAMP MICRO.....	p. 219
TRIDON GEAR CLAMP.....	p. 220
TRIDON GEAR CLAMP SILICONE.....	p. 221
GEAR CLAMP STAINLESS.....	p. 223
GEAR CLAMP STAINLESS.....	p. 223
GEAR CLAMP MICRO STAINLESS.....	p. 224
GEAR CLAMP STAINLESS QUICK RELEASE.....	p. 224
TRIDON GEAR CLAMP STAINLESS.....	p. 225
TRIDON GEAR CLAMP MICRO STAINLESS.....	p. 226
TRIDON STAINLESS QUICK RELEASE.....	p. 226
CENTRE PUNCH.....	p. 227
HAMMERLOCK TOOLS.....	p. 227
HAMMER LOCK CLAMPS.....	p. 228
HAMMER LOCK CLAMPS STAINLESS.....	p. 229
PREFORMED CLAMP.....	p. 230
PREFORMED CLAMP STAINLESS.....	p. 231
OPEN END CLAMP.....	p. 232
PREFORMED CLAMP STAINLESS AND GALVANIZED J TYPE.....	p. 232
OPEN END CLAMP STAINLESS.....	p. 233
STAINLESS BAND.....	p. 233
STAINLESS BUCKLES.....	p. 233
P1 HAMMERLOCK PARTS.....	p. 234
P1000 PARTS.....	p. 234
P38 PARTS.....	p. 234
TPT TOOLS AND PARTS.....	p. 235
P300 PARTS.....	p. 235
CIRCLE CLAMP.....	p. 237
CIRCLE CLAMP 2 EAR.....	p. 237
OETIKER CLAMP 2 EAR.....	p. 238
OETIKER CLAMP 2 EAR STAINLESS.....	p. 239
SIDE JAW PINCER.....	p. 239
SK 1098 KIT.....	p. 239
STRAIGHT JAW PINCER.....	p. 240
MAXI CLAMPS.....	p. 241
M6 MAXI CLAMP LIGHT.....	p. 241
M6 STAINLESS MAXI CLAMP LIGHT.....	p. 241
M8 MAXI CLAMP STANDARD.....	p. 242
M8 MAXI CLAMP STAINLESS.....	p. 243
M10 MAXI CLAMP DOUBLE BOLT.....	p. 244

TABLE OF CONTENTS

M10 MAXI CLAMP HEAVY.....	p. 245
MEGAKLAMP.....	p. 247
MEGAKLAMP.....	p. 247
SPIRAL CLAMP.....	p. 249
SPIRAL CLAMP LEFT.....	p. 249
SPIRAL CLAMP RIGHT.....	p. 249
HIGH PRESSURE CLAMP.....	p. 251
2 BOLT HIGH PRESSURE CLAMP.....	p. 251
4 BOLT HIGH PRESSURE CLAMP.....	p. 252
6 BOLT HIGH PRESSURE CLAMP.....	p. 253
HIGH PRESSURE GROUND JOINT.....	p. 255
HIGH PRESSURE DOUBLE SPUD.....	p. 255
HIGH PRESSURE FEMALE SPUD.....	p. 255
HIGH PRESSURE MALE SPUD.....	p. 255
HIGH PRESSURE FEMALE STEM.....	p. 256
HIGH PRESSURE MALE STEM.....	p. 256
HIGH PRESSURE MENDER.....	p. 257
HIGH PRESSURE WING NUT.....	p. 257
NPT STEEL HEX NIPPLE.....	p. 258
MINE FITTING.....	p. 259
EXTRA LONG MINE JOINER.....	p. 259
MINE SPUD.....	p. 259
MINE JOINER.....	p. 259
MINE NUT.....	p. 259
MINE STEM.....	p. 260
CHAMF THREADED NIPPLE.....	p. 260
EXTRA LONG MINE STEM.....	p. 260
UNIVERSAL.....	p. 261
UNIVERSAL FEMALE END.....	p. 261
UNIVERSAL MALE END.....	p. 261
UNIVERSAL HOSE END.....	p. 261
UNIVERSAL FEMALE END STAINLESS.....	p. 262
UNIVERSAL MALE END STAINLESS.....	p. 262
UNIVERSAL HOSE END STAINLESS.....	p. 262
UNIVERSAL FEMALE END BRASS.....	p. 262
UNIVERSAL MALE END BRASS.....	p. 263
UNIVERSAL HOSE END BRASS.....	p. 263
UNIVERSAL BLANK END.....	p. 263
UNIVERSAL BLANK END STAINLESS.....	p. 263
UNIVERSAL TRIPLE CONNECTOR.....	p. 264
UNIVERSAL WASHER.....	p. 264
UNIVERSALS SAFETY CLIP.....	p. 264
NATIONAL QUICK RELEASE AIR.....	p. 265
NATIONAL SERIES A COUPLING.....	p. 265
NATIONAL SERIES A HOSE END.....	p. 265
NATIONAL SERIES A BRASS.....	p. 265
NATIONAL SERIES B FEMALE HEAD X FEMALE NPT.....	p. 266
NATIONAL SERIES B FEMALE HEAD X MALE NPT.....	p. 266
NATIONAL SERIES B FEMALE HEAD X SHANK.....	p. 266
NATIONAL SERIES B MALE HEAD X FEMALE NPT.....	p. 266
NATIONAL SERIES B MALE HEAD X MALE NPT.....	p. 266
NATIONAL SERIES B MALE HEAD X SHANK.....	p. 267
NATIONAL GASKET.....	p. 267
VITON GASKET FOR A SERIES.....	p. 267
LOCKING KEY EXCLUDING MLS,FLS,FLS.....	p. 267
LOCKING KEY MLS,FLS,FLS.....	p. 267
SPRING LOCK FOR NATIONAL CPLG.....	p. 267

TABLE OF CONTENTS

OTHER COUPLING.....	p. 269
THREADED CAST IRON FLANGE 125 - 150#.....	p. 269
FLANGE GASKET.....	p. 269
LARGE SAFETYCHECK FOR HOSE/HOSE AND HOSE/TOOL.....	p. 270
MEDIUM SAFETYCHECK FOR HOSE/HOSE.....	p. 270
SMALL SAFETYCHECK FOR HOSE/HOSE AND HOSE/TOOL.....	p. 270
PLASTIC FOG NOZZLE NPS.....	p. 270
PLASTIC FOG NOZZLE GHT.....	p. 271
GREEN ABS FOG NOZZLE GHT.....	p. 271
PLASTIC FOG NOZZLE GASKET.....	p. 271
BRASS NOZZLE.....	p. 271
CSA/NPT BRASS HYDRANT ADAPTER.....	p. 271
MALE X MALE SWIVEL PRESSURE WASHER SET.....	p. 272
BRASS BARB MALE SWIVEL.....	p. 272
BRASS BARB FEM.....	p. 272
BRASS BARB MALE SOLID.....	p. 273
STRAINERS.....	p. 275
STRAINER POLYPROPYLENE.....	p. 275
STRAINER ROUND HOLE.....	p. 275
STRAINER SQUARE HOLE.....	p. 275
STRAINER TOP HOLE.....	p. 275
STRAINER BOTTOM HOLE.....	p. 276
STRAINER ROUND HOLE LONG THIN.....	p. 276
FOOT VALVE.....	p. 277
FOOT VALVE.....	p. 277
STRAINER FOR FOOT VALVE.....	p. 277
SEAT PLATE FOR FOOT VALVE.....	p. 277
FLAPPER FOR FOOT VALVE.....	p. 278
FOOT VALVE LEATHER.....	p. 278
BALL VALVE.....	p. 279
BALL VALVE FULL PORT BRASS NPT.....	p. 279
BALL VALVE FULL PORT STAINLESS NPT.....	p. 279
POLYPROPYLENE BOLTED BALL VALVE ECONO TYPE.....	p. 280
POLYPROPYLENE BOLTED BALL VALVE CAMLOCK TYPE.....	p. 280
POLYPROPYLENE BOLTED BALL VALVE.....	p. 281
POLYPROPYLENE BOLTED BALL VALVE WITH NOZZLE.....	p. 282
SANDBLAST.....	p. 283
SANDBLAST COUPLING ALUMINUM.....	p. 283
SANDBLAST COUPLING BRASS.....	p. 283
SANDBLAST COUPLING NYLON.....	p. 283
NOZZLE HOLDER ALUMINUM FEMALE NPT.....	p. 284
NOZZLE HOLDER BRASS FEMALE NPT.....	p. 284
NOZZLE HOLDER NYLON FEMALE NPT.....	p. 284
THREADED ADAPTER ALUMINUM FEMALE NPT.....	p. 284
THREADED ADAPTER BRASS FEMALE NPT.....	p. 285
THREADED ADAPTER NYLON FEMALE NPT.....	p. 285
THREADED ADAPTER ALUMINUM FEMALE NPS.....	p. 285
THREADED ADAPTER BRASS FEMALE NPS.....	p. 285
SANDBLAST GASKET.....	p. 286
SANDBLAST GASKET FULL PORT.....	p. 286
FIRE PYROLITE.....	p. 287
FORESTRY FITTING.....	p. 287
PYROLITE SET NPS.....	p. 287
PYROLITE SET CSA.....	p. 287
STORZ CLAMPS.....	p. 288
FIRE BRASS.....	p. 289
BRASS SET NPSH.....	p. 289

TABLE OF CONTENTS

BRASS SET CSA.....	p. 289
PIPE FITTING.....	p. 291
CLOSE NIPPLE BLACK.....	p. 291
REDUCING BUSHING BLACK.....	p. 291
REDUCING COUPLING BLACK.....	p. 292
STRAIGHT COUPLING BLACK.....	p. 292
BUTYL.....	p. 293
REGULAR BUTYL.....	p. 293
HYPALON.....	p. 293
REGULAR HYPALON.....	p. 293
EPDM.....	p. 294
REGULAR EPDM.....	p. 294
NEOPRENE.....	p. 295
REGULAR NEOPRENE.....	p. 295
WHITE NITRILE.....	p. 296
WHITE NITRILE.....	p. 296
NITRILE.....	p. 296
REGULAR NITRILE.....	p. 296
PURE GUM.....	p. 297
PURE GUM.....	p. 297
CHUTE AND LAUNDRER - 1 OUTER FABRIC PLY.....	p. 297
CHUTE AND LAUNDRER - 1 OUTER PLY FABRIC.....	p. 297
DIAPHRAGM SHEET NEOPRENE/NYLON.....	p. 298
REGULAR NEOPRENE DIAPHRAGM SHEET.....	p. 298
MATTING.....	p. 298
MATTING.....	p. 298
RED SHEET.....	p. 299
REGULAR RED SHEET.....	p. 299
CLOTH IMPRESSION RED SHEET.....	p. 299
PREMIUM CLOTH IMPRESSION RED SHEET.....	p. 299
SBR.....	p. 300
SBR.....	p. 300
SILICONE.....	p. 301
REGULAR SILICONE.....	p. 301
SBR SKIRTBOARD.....	p. 302
SBR SKIRTBOARD.....	p. 302
VITON.....	p. 303
VITON.....	p. 303
Index For Hose By Working Pressure (PSI).....	p. 304

HOSE APPLICATION TABLE OF CONTENTS

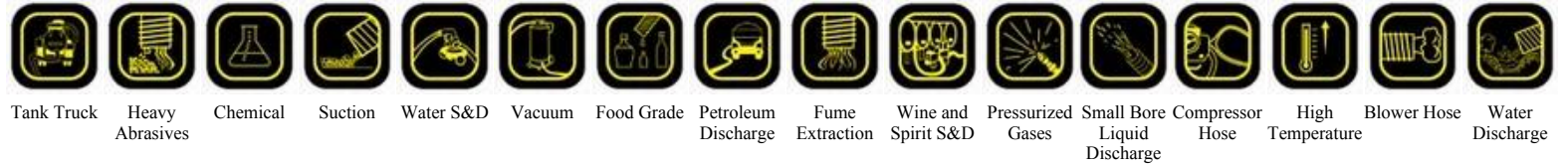

AIR

CONTRACTORS 400 AIR												•		•			
JACKHAMMER - YELLOW AIR												•		•			
CONTRACTORS AIR												•		•			
SUPER SERVICE AIR												•		•			
STEELFLEX AIR												•		•			
OROFLEX AIR/WATER LAYFLAT DISCHARGE												•		•			•
MONTANA												•		•			
SUPER GREEN ORS												•		•			
HOT AIR BLOWER HOSE												•				•	

GENERAL PURPOSE

CLEAR REINFORCED PVC (FOOD QUALITY)			•				•					•	•	•			
REINFORCED CLEAR PVC												•	•	•			
GENERAL PURPOSE												•	•	•			
EPDM GENERAL PURPOSE			•									•	•	•			
PREMIUM GENERAL PURPOSE - NON CONDUCTIVE												•	•	•			
ARCTIC SUPERFLEX GENERAL PURPOSE							•					•	•	•			
PUSH - ON BLACK							•					•	•	•			
PUSH - ON GREEN							•					•	•	•			
PUSH - ON BLUE							•					•	•	•			
PUSH - ON GREY							•					•	•	•			
PUSH - ON RED							•					•	•	•			
PUSH - ON YELLOW							•					•	•	•			
SELF-STORING AIR-URETHANE ASSEMBLY												•		•			
SELF-STORING AIR-NYLON												•		•			

HOSE APPLICATION TABLE OF CONTENTS

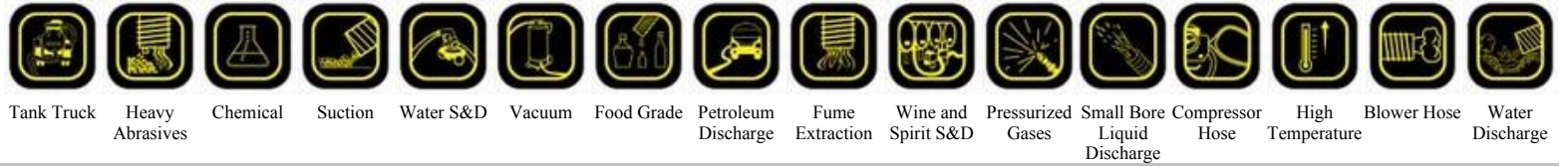

WATER DISCHARGE

BLUE LAYFLAT																	•
BROWN LAYFLAT																	•
GREEN LAYFLAT																	•
OROFLEX - PREMIUM RUBBER LAYFLAT																	•
DURAFLEX - RUBBER LAYFLAT																	•
CONTRACTORS WATER DISCHARGE - GARDEN HOSE												•					•
CONTRACTORS WATER DISCHARGE																	•
PAPERMILL WASHDOWN												•					•
CONTRACTORS PLUS WATER DISCHARGE																	•
PACKERS WASHDOWN													•				•
HEAVY DUTY WATER DISCHARGE/LOW PRESSURE AIR																	•
SUPREME WHITE SANITARY													•				•
HIGH PRESSURE CONTRACTORS WATER DISCHARGE																	•
WHITE SANITARY														•			•

WATER SUCTION

SATURN PVC WATER S&D	•			•	•												•
SATURN WHITE PVC WATER SUCTION AND DISCHARGE HOSE	•			•	•												•
SUPERFLEX PVC SUCTION	•			•	•												•
HEAVY DUTY PVC WATER S&D	•			•	•												•
RUBBER WATER S&D					•												•

HOSE APPLICATION TABLE OF CONTENTS

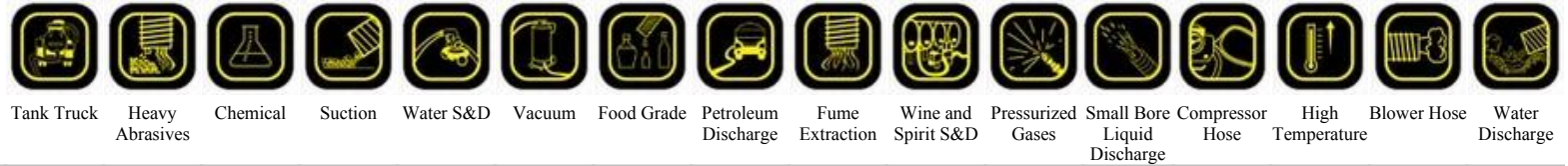

CHEMICAL	•		•	•				•								
FLEXCHEM	•		•	•				•								

MATERIAL HANDLING

AZTEC SLURRY HOSE		•		•												•
GUNITE		•														
BULKMASTER HARDWALL		•		•												•
BULKMASTER SOFTWALL		•														•
TAN BULKMASTER	•			•		•										
INDUSTRIAL VACUUM HEAVY DUTY	•	•		•		•										•
INDUSTRIAL VACUUM	•	•		•		•										•

MATERIAL HANDLING POLYURETHANE AND PVC

ARI SUCTION	•	•		•	•	•										
B - FLEX (FOOD GRADE)				•		•	•		•							
B - FLEX (STATIC) (FOOD GRADE)				•		•	•		•							
GREY PVC VACUUM				•		•			•							
NEPTUNE PVC SUCTION (FOOD GRADE)				•	•	•	•									
NEPTUNE STATIC PVC SUCTION (FOOD GRADE)				•	•	•	•									
PU VAC (FOOD QUALITY)				•		•	•		•							
PU VAC LIGHT (FOOD QUALITY)				•		•	•		•							

FOOD

BACCO - PVC WINE SUCTION (FOOD QUALITY)				•	•		•			•						
BREWERS & BEVERAGE DISCHARGE							•			•						
BREWERS SUCTION HOSE				•			•			•						

HOSE APPLICATION TABLE OF CONTENTS

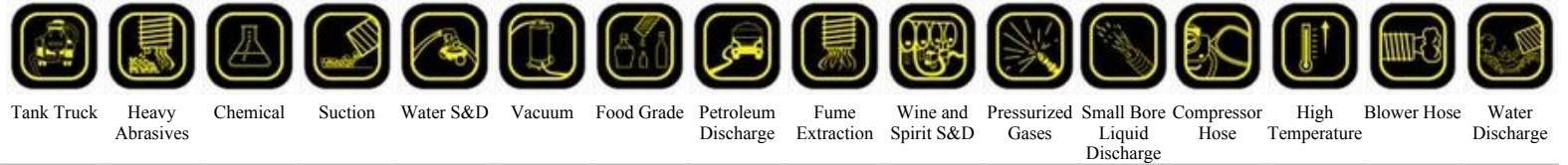

	Tank Truck	Heavy Abrasives	Chemical	Suction	Water S&D	Vacuum	Food Grade	Petroleum Discharge	Fume Extraction	Wine and Spirit S&D	Pressurized Gases	Small Bore Liquid Discharge	Compressor Hose	High Temperature	Blower Hose	Water Discharge
FOODFLEX PVC S&D (FOOD QUALITY)				•	•		•			•						•
CLEARFLEX PVC SUCTION & DISCHARGE (FOOD QUALITY)				•	•		•			•						•
FOODFLEX RUBBER SUCTION HOSE				•			•									
POLYETHYLENE TUBING							•				•	•				
CLEAR VINYL TUBING							•					•				
WIREVAC (FOOD QUALITY)	•			•	•		•									•
SUPER WIREVAC (FOOD QUALITY)	•			•	•		•									•

DUCTING

TPR/RFH			•						•							
SUPER VAC-U-FLEX						•										
NC1									•							
NC2									•							
VAC-U-LOK						•			•							
SPIRATUBE - TDS & TDHS									•							
TPU VAC-U-FLEX									•							
TPE VAC-U-FLEX									•							
U1 FLEX FLYTE									•					•		
L1 FLEX FLYTE									•					•		
U9 FLEX FLYTE									•					•		
L9 FLEX FLYTE									•					•		
1PNEPW															•	
DURATHANE LD/ "UFD"		•							•							
DURATHANE MD/ "UFD.045"		•							•							
SLP10 FLEXVENT															•	
MARINE FUEL FILL - HARDWALL								•								
FUEL LINE								•				•				

HOSE APPLICATION TABLE OF CONTENTS

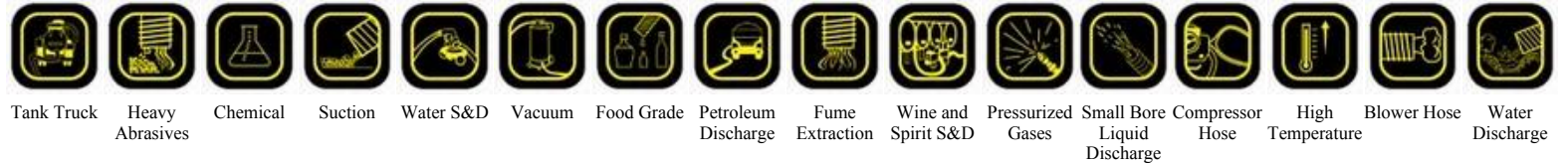

	Tank Truck	Heavy Abrasives	Chemical	Suction	Water S&D	Vacuum	Food Grade	Petroleum Discharge	Fume Extraction	Wine and Spirit S&D	Pressurized Gases	Small Bore Liquid Discharge	Compressor Hose	High Temperature	Blower Hose	Water Discharge
SILICONE COOLANT HOSE														•		•
SILICONE HEATER HOSE												•		•		
AUTO HEATER												•				•
GARAGE EXHAUST HOSE									•							

FIRE

ARMTEX RUBBER COVERED FM APPROVED, ULC LISTED																	•
ARMTEX HD RUBBER COVERED ULC LISTED																	•
DOUBLE JACKET 800 PSI																	•
SINGLE JACKET INDUSTRIAL MILL																	•
DURAFLO BLUE (RUBBER COVERED STANDPIPE WASHDOWN)																	•
RACK HOSE																	•

OTHER HOSE

PRESSURE WASHER												•					
PAINT SPRAY												•					
PAINT SPRAY NYLON												•					

WELDING

SINGLE LINE WELDING TYPE S GRADE R												•					
SINGLE LINE WELDING TYPE S GRADE RM												•					
TWIN WELDING TYPE VD GRADE R												•					
TWIN WELDING TYPE VD GRADE RM												•					

CONTRACTORS 400 AIR



- Application** : For mining, construction, and industrial use
- Cover** : Yellow cut and abrasion resistant rubber with blue stripe
- Reinforcement** : Multiple layers of synthetic yarn
- Tube** : Synthetic oil mist resistant
- Temperature** : -35C to +80C(-30F to +180F)

Nom. I.D	Nom. O.D	PSI	Weight (lbs)	Std Pack Qty	Part #
1/2"	0.89"	400	0.23	50'	CAY400-050-50
1/2"	0.89"	400	0.23	100'	CAY400-050-100
3/4"	1.18"	400	0.38	50'	CAY400-075-50
3/4"	1.18"	400	0.38	100'	CAY400-075-100
1"	1.42"	400	0.43	50'	CAY400-100-50
1"	1.42"	400	0.43	100'	CAY400-100-100

Cut Lengths : No Cut Lengths
Standard Lengths : 50'/100'
Product Information : Please specify length required when ordering, i.e. 50', 100'. Lengths to 200' available, check for pricing and availability
Recommended Couplings : High Pressure all sizes, mine stem and nut 1/2" - 2", Universal quick acting 1/2" - 1"

JACKHAMMER - YELLOW AIR



- Application** : An economical air hose for jackhammer and other uses on construction sites. Also for general industrial use
- Cover** : Yellow smooth cut and abrasion resistant
- Reinforcement** : Multiple layers of synthetic yarn
- Tube** : Synthetic oil mist resistant
- Temperature** : -35C to +80C(-30F to +180F)

Nom. I.D	Nom. O.D	PSI	Weight (lbs)	Std Pack Qty	Part #
3/4"	1.14"	300	0.43	300'	JACK-075
3/4"	1.14"	300	0.43	50'	JACK-075-50

Cut Lengths : Plus 5%
Standard Lengths : 50'/300' coils
Recommended Couplings : High Pressure, mine stem and nut, Universal quick acting

Air and General Purpose Hose

CONTRACTORS AIR



Water Suction and Discharge Hose

- Application** : For mining, construction, and industrial use
Cover : Yellow cut and abrasion resistant rubber
Reinforcement : Multiple layers of synthetic yarn
Tube : Synthetic oil mist resistant
Temperature : -35C to +80C(-30F to +180F)

Petroleum, Steam and Chemical Hose

Rubber Material Handling Hose

Plastic Material Handling Hose

Food Hose

Ducting

Auto Truck and Marine Hose

Fire Hose

Welding and Other Hose

Cam and Groove

Nipples, Menders and Shank Fittings

Clamps

High Pressure Fittings

Mine Fittings

Air Fittings

Valves

Sandblast

Fire Fittings

Pipe Fittings

Sheet Rubber

Index and Technical Information

	Nom. I.D	Nom. O.D	PSI	Weight (lbs)	Std Pack Qty	Part #
Rubber Material Handling Hose	1/2"	0.91"	300	0.32	50'	CAY-050-50
Plastic Material Handling Hose	1/2"	0.91"	300	0.32	100'	CAY-050-100
Food Hose	3/4"	1.18"	300	0.48	50'	CAY-075-50
	3/4"	1.18"	300	0.48	100'	CAY-075-100
Ducting	1"	1.50"	300	0.70	50'	CAY-100-50
Auto Truck and Marine Hose	1"	1.50"	300	0.70	100'	CAY-100-100
	1-1/4"	1.69"	300	0.73	50'	CAY-125-50
Fire Hose	1-1/4"	1.69"	300	0.73	100'	CAY-125-100
	1-1/2"	1.97"	300	0.93	50'	CAY-150-50
Welding and Other Hose	1-1/2"	1.97"	300	0.93	100'	CAY-150-100
	2"	2.60"	300	1.56	50'	CAY-200-50
Cam and Groove	2"	2.60"	300	1.56	100'	CAY-200-100
	2-1/2"	3.03"	250	1.67	100'	CAY-250
Nipples, Menders and Shank Fittings	3"	3.66"	250	2.00	100'	CAY-300
	4"	4.68"	250	2.71	100'	CAY-400

Cut Lengths : Plus 10%

Standard Lengths : 50'/100'

Product Information : Please specify length required when ordering, i.e. 50', 100'. Lengths to 200' available, check for pricing and availability

Recommended Couplings : High Pressure all sizes, mine stem and nut 1/2" - 2", Universal quick acting 1/2" - 1"

SUPER SERVICE AIR



Air and General Purpose Hose

Water Suction and Discharge Hose

Petroleum, Steam and Chemical Hose

Rubber Material Handling Hose

Plastic Material Handling Hose

Food Hose

Ducting

Auto Truck and Marine Hose

Fire Hose

Welding and Other Hose

Cam and Groove

Nipples and Shank Fittings

Clamps

High Pressure Fittings

Mine Fittings

Air Fittings

Valves

Sandblast

Fire Fittings

Pipe Fittings

Sheet Rubber

Index and Technical Information

- Application** : A superior quality mining, construction and industrial hose
- Cover** : Yellow cut and abrasion resistant rubber with blue stripe
- Reinforcement** : Multiple layers of synthetic yarn
- Tube** : Synthetic oil mist resistant
- Temperature** : -35C to +80C(-30F to +180F)

Nom. I.D	Nom. O.D	PSI	Weight (lbs)	Std Pack Qty	Part #
1/2"	0.91"	400	0.32	50'	SSY-050-50
1/2"	0.91"	400	0.32	100'	SSY-050-100
3/4"	1.26"	400	0.58	50'	SSY-075-50
3/4"	1.26"	400	0.58	100'	SSY-075-100
1"	1.50"	400	0.70	50'	SSY-100-50
1"	1.50"	400	0.70	100'	SSY-100-100
1-1/4"	1.85"	400	1.04	50'	SSY-125-50
1-1/4"	1.85"	400	1.04	100'	SSY-125-100
1-1/2"	2.09"	400	1.20	50'	SSY-150-50
1-1/2"	2.09"	400	1.20	100'	SSY-150-100
2"	2.60"	400	1.56	50'	SSY-200-50
2"	2.60"	400	1.56	100'	SSY-200-100
2-1/2"	3.11"	400	1.56	100'	SSY-250
3"	3.74"	400	2.86	100'	SSY-300
4"	4.72"	400	3.02	100'	SSY-400

Cut Lengths : Plus 10%. No cut lengths on 2-1/2" - 3" or 4"

Standard Lengths : 50'/100'

Product Information : Please specify length required when ordering, i.e. 50', 100'.

Recommended Couplings : High Pressure all sizes, mine stem and nut 1/2" - 2", Universal quick acting 1/2" - 1"

Air and General Purpose Hose

Water Suction and Discharge Hose

Petroleum, Steam and Chemical Hose

Rubber Material Handling Hose

Plastic Material Handling Hose

Food Hose

Ducting

Auto Truck and Marine Hose

Fire Hose

Welding and Other Hose

Cam and Groove

Nipples Menders and Shank Fittings

Clamps

High Pressure Fittings

Mine Fittings

Air Fittings

Valves

Sandblast

Fire Fittings

Pipe Fittings

Sheet Rubber

Index and Technical Information

STEEFLEX AIR



- Application** : High pressure air service for mining, construction and industrial use. More resistant to external abuse than textile air hose. Mandrel built
- Cover** : Yellow cut and abrasion resistant rubber with red stripe
- Reinforcement** : Multiple layers of high tensile steel cords
- Tube** : Synthetic oil mist resistant
- Temperature** : -35C to +80C(-30F to +180F)

	Nom. I.D	Nom. O.D	PSI	Weight (lbs)	Std Pack Qty	Part #
	1/2"	0.98"	1000	0.37	50'	SFY-050-50
	1/2"	0.98"	1000	0.37	100'	SFY-050-100
	3/4"	1.26"	800	0.49	50'	SFY-075-50
	3/4"	1.26"	800	0.49	100'	SFY-075-100
	1"	1.50"	800	0.66	50'	SFY-100-50
	1"	1.50"	800	0.66	100'	SFY-100-100
	1-1/4"	1.77"	600	0.80	50'	SFY-125-50
	1-1/4"	1.77"	600	0.80	100'	SFY-125-100
	1-1/2"	2.09"	600	1.03	50'	SFY-150-50
	1-1/2"	2.09"	600	1.03	100'	SFY-150-100
	2"	2.60"	600	1.51	50'	SFY-200-50
	2"	2.60"	600	1.51	100'	SFY-200-100
	2-1/2"	3.15"	500	2.12	100'	SFY-250
	3"	3.82"	500	3.06	50'	SFY-300-50
	3"	3.82"	500	3.06	100'	SFY-300-100
	4"	4.84"	400	4.07	100'	SFY-400

Cut Lengths : Plus 10%, No cut lengths on 4".

Standard Lengths : 50'/100'

Product Information : Please specify length required when ordering, i.e. 50', 100'. Lengths to 400' available, check for pricing and availability

Recommended Couplings : High Pressure all sizes, mine stem and nut 1/2" - 2", Universal quick acting 1/2" - 1"

OROFLEX AIR/WATER LAYFLAT DISCHARGE



- Application** : A superior quality, lightweight, highly portable, high pressure air hose. Ideal where excessive oil is a factor. One man can carry 100'.
Cover : Yellow abrasion, weather and oil resistant nitrile rubber.
Reinforcement : Circular woven high strength polyester yarns.
Tube : Yellow abrasion and oil resistant nitrile rubber.
Temperature : -20C to +80C(0F to +180F)

Nom. I.D	Nom. O.D	PSI Air	PSI Water	Weight (lbs)	Std Pack Qty	Part #
3/4"	0.98"	300	400	0.10	200'	ORO20-075
1"	1.34"	300	400	0.14	200'	ORO20-100
1-1/2"	1.86"	200	300	0.30	200'	ORO20-150
2"	2.36"	200	300	0.44	200'	ORO20-200
3"	3.40"	150	250	0.64	200'	ORO20-300
4"	4.40"	150	250	0.86	200'	ORO20-400

Cut Lengths : No Cut Lengths

Standard Lengths : 50'/100'/200'

Safety Information : Not recommended for Bull Hose use in quarries or other areas where external cutting may occur

Recommended Couplings : High Pressure all sizes, mine stem and nut 1/2" - 2"

MONTANA



- Application** : Underground mining and other rugged service.
Cover : Extra thick orange cut and abrasion resistant rubber cover for the ultimate resistance to wear.
Reinforcement : Multiple layers of synthetic yarn.
Tube : Synthetic oil mist resistant.
Temperature : -35C to +80C(-30F to +180F)

Nom. I.D	Nom. O.D	PSI	Weight (lbs)	Std Pack Qty	Part #
1/2"	1.20"	400	0.47	100'	MON-050
3/4"	1.50"	400	0.70	100'	MON-075
1"	1.73"	400	0.95	100'	MON-100
1-1/4"	2.01"	400	1.30	100'	MON-125
1-1/2"	2.24"	400	1.40	100'	MON-150
2"	2.76"	400	1.75	100'	MON-200

Cut Lengths : No Cut Lengths

Standard Lengths : 50'/100'

Recommended Couplings : High Pressure, mine stem and nut

Air and General Purpose Hose

Water Suction and Discharge Hose

Petroleum, Steam and Chemical Hose

Rubber Material Handling Hose

Plastic Material Handling Hose

Food Hose

Ducting

Auto Truck and Marine Hose

Fire Hose

Welding and Other Hose

Cam and Groove

Nipples Menders and Shank Fittings

Clamps

High Pressure Fittings

Mine Fittings

Air Fittings

Valves

Sandblast

Fire Fittings

Pipe Fittings

Sheet Rubber

Index and Technical Information

Air and General Purpose Hose

SUPER GREEN ORS



Water Suction and Discharge Hose

- Application** : A superior quality mining, construction and industrial hose with oil resistant tube.
Cover : Green cut and abrasion resistant rubber.
Reinforcement : Multiple layers of synthetic yarn
Tube : Synthetic oil resistant
Temperature : -35C to +80C(-30F to +180F)

Petroleum, Steam and Chemical Hose

Rubber Material Handling Hose

	Nom. I.D	Nom. O.D	PSI	Weight (lbs)	Std Pack Qty	Part #
	1/2"	0.91"	400	0.32	100'	SGO-050
	3/4"	1.26"	400	0.58	100'	SGO-075
	1"	1.50"	400	0.70	100'	SGO-100
	1-1/4"	1.85"	400	1.04	100'	SGO-125
	1-1/2"	2.09"	400	1.20	100'	SGO-150
	2"	2.60"	400	1.56	100'	SGO-200

Plastic Material Handling Hose

Food Hose

Ducting

Auto Truck and Marine Hose

- Cut Lengths** : Plus 10%.
Standard Lengths : 50'/100'
Product Information : Please specify length required when ordering, i.e. 50', 100'.
Recommended Couplings : High Pressure all sizes, mine stem and nut 1/2" - 2", Universal quick acting 1/2" - 1"

Fire Hose

Welding and Other Hose

HOT AIR BLOWER HOSE

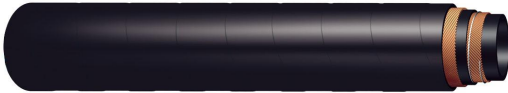

Cam and Groove

Nipples, Menders and Shank Fittings

Clamps

High Pressure Fittings

Mine Fittings

Air Fittings

Valves

Sandblast

Fire Fittings

Pipe Fittings

Sheet Rubber

Index and Technical Information

- Application** : For conveying hot air from blower to tank on dry bulk trucks.
Cover : Black heat and weather resistant EPDM rubber.
Reinforcement : High tensile wire helix embedded between layers of heat resistant synthetic fabric.
Tube : Black specially compounded heat resistant EPDM rubber.
Temperature : -40C to +163C(-40F to +350F)

	Nom. I.D	Nom. O.D	PSI	Bend Radius	Weight (lbs)	Std Pack Qty	Part #
	3"	3.60"	50	12.00"	1.75	100'	BLOW-300
	4"	4.63"	50	15.00"	2.40	100'	BLOW-400

- Recommended Couplings** : Cam and Groove
Cut Lengths : Plus 10%
Standard Lengths : 100'

CLEAR REINFORCED PVC (FOOD QUALITY)



- Application** : An economical hose for handling air, water, oil, mild chemicals, and alkalis. Clear wall allows visual inspection of product.
- Cover** : Clear smooth PVC
- Reinforcement** : Multiple layers of synthetic yarns
- Tube** : Clear smooth PVC
- Temperature** : -5C to +65C(+25F to +150F)

Nom. I.D	Nom. O.D	PSI	Weight (lbs)	Std Pack Qty	Part #
3/16"	0.38"	250	0.05	300'	CRPVC-019
1/4"	0.46"	250	0.07	300'	CRPVC-025
1/4"	0.46"	250	0.07	100'	CRPVC-025-100
5/16"	0.53"	250	0.08	300'	CRPVC-031
3/8"	0.60"	250	0.09	300'	CRPVC-038
3/8"	0.60"	250	0.09	100'	CRPVC-038-100
1/2"	0.75"	200	0.15	300'	CRPVC-050
1/2"	0.75"	200	0.15	100'	CRPVC-050-100
5/8"	0.88"	200	0.17	300'	CRPVC-063
3/4"	1.03"	150	0.23	300'	CRPVC-075
3/4"	1.03"	150	0.23	100'	CRPVC-075-100
1"	1.31"	125	0.32	200'	CRPVC-100
1"	1.31"	125	0.32	100'	CRPVC-100-100
1-1/4"	1.69"	100	0.58	100'	CRPVC-125
1-1/2"	1.94"	100	0.69	100'	CRPVC-150
2"	2.50"	75	1.00	100'	CRPVC-200

Cut Lengths : Plus 10%

Standard Lengths : 3/16"-3/4" 100'/300' coil, 1" 100'/200' coil, 1-1/4"-2" 100' coil

Product Information : Please specify length when ordering i.e. 100' or 300'

Safety Information : Working pressure ratings are based on 20C (68F). At operating temperature of +65C (150F) reduce working pressure by 50%.

Recommended Couplings : Combination nipples, short shank, brass barbed, cam and groove

- Air and General Purpose Hose
- Water Suction and Discharge Hose
- Petroleum, Steam and Chemical Hose
- Rubber Material Handling Hose
- Plastic Material Handling Hose
- Food Hose
- Ducting
- Auto Truck and Marine Hose
- Fire Hose
- Welding and Other Hose
- Cam and Groove
- Nipples Menders and Shank Fittings
- Clamps
- High Pressure Fittings
- Mine Fittings
- Air Fittings
- Valves
- Sandblast
- Fire Fittings
- Pipe Fittings
- Sheet Rubber
- Index and Technical Information

Air and General Purpose Hose

Water Suction and Discharge Hose

Petroleum, Steam and Chemical Hose

Rubber Material Handling Hose

Plastic Material Handling Hose

Food Hose

Ducting

Auto Truck and Marine Hose

Fire Hose

Welding and Other Hose

Cam and Groove

Nipples, Menders and Shank Fittings

Clamps

High Pressure Fittings

Mine Fittings

Air Fittings

Valves

Sandblast

Fire Fittings

Pipe Fittings

Sheet Rubber

Index and Technical Information

REINFORCED CLEAR PVC



Application

: An economical hose for handling air, water, oil, mild chemicals, and alkalis. Clear wall allows visual inspection of product.

Cover

: Clear smooth PVC

Reinforcement

: Multiple layers of synthetic yarns

Temperature

: -5C to +65C(+25F to +150F)

	Nom. I.D	Nom. O.D	PSI	Weight (lbs)	Std Pack Qty	Part #
	3/16"	0.38"	250	0.05	300'	RCPVC-019
	1/4"	0.46"	250	0.07	300'	RCPVC-025
	5/16"	0.53"	250	0.08	300'	RCPVC-031
	3/8"	0.60"	250	0.09	300'	RCPVC-038
	1/2"	0.75"	200	0.15	300'	RCPVC-050
	5/8"	0.88"	200	0.17	300'	RCPVC-063
	3/4"	1.03"	150	0.23	300'	RCPVC-075
	1"	1.31"	125	0.32	300'	RCPVC-100
	1-1/4"	1.69"	100	0.58	300'	RCPVC-125
	1-1/2"	1.94"	100	0.69	300'	RCPVC-150
	2"	2.50"	75	1.00	300'	RCPVC-200

Cut Lengths : Plus 10%

Standard Lengths : 3/16"-3/4" 300' coil, 1" 200' coil, 1-1/4"-2" 100' coil

Safety Information : Working pressure ratings are based on 20C (68F). At operating temperature of +65C (150F) reduce working pressure by 50%.

Recommended Couplings : Combination nipples, short shank, brass barbed, cam and groove

GENERAL PURPOSE



- Application** : General air-line and water service both in plant and outdoors
- Cover** : Red smooth weather and abrasion resistant synthetic rubber
- Reinforcement** : Multiple layers of synthetic yarns
- Tube** : Black oil mist resistant synthetic rubber
- Temperature** : -30C to +80C(-22F to +180F)

Nom. I.D	Nom. O.D	PSI	Weight (lbs)	Std Pack Qty	Part #
1/4"	0.55"	250	0.13	300'	GP-025-250
3/8"	0.67"	200	0.19	300'	GP-038-200
3/8"	0.71"	250	0.19	300'	GP-038-250
1/2"	0.83"	200	0.23	300'	GP-050-200
1/2"	0.87"	250	0.27	300'	GP-050-250
3/4"	1.16"	250	0.42	300'	GP-075-250
1"	1.42"	200	0.54	300'	GP-100-200
1-1/4"	1.73"	150	0.64	100'	GP-125-150
1-1/2"	2.05"	150	0.74	100'	GP-150-150
2"	2.60"	150	1.01	100'	GP-200-150

Cut Lengths : Plus 5%

Standard Lengths : 1/4"- 1" 50'/100'/300'. 1-1/4" - 2" 50'/100'.

Recommended Couplings : High Pressure 1" - 1-1/2" for air service if the working pressure exceeds 150 psi. High Pressure, Short shank, universal, or Combination nipples all other sizes.

Air and General Purpose Hose

Water Suction and Discharge Hose

Petroleum, Steam and Chemical Hose

Rubber Material Handling Hose

Plastic Material Handling Hose

Food Hose

Ducting

Auto Truck and Marine Hose

Fire Hose

Welding and Other Hose

Cam and Groove

Nipples Menders and Shank Fittings

Clamps

High Pressure Fittings

Mine Fittings

Air Fittings

Valves

Sandblast

Fire Fittings

Pipe Fittings

Sheet Rubber

Index and Technical Information

Air and General Purpose Hose

EPDM GENERAL PURPOSE

Water Suction and Discharge Hose



Petroleum, Steam and Chemical Hose

- Application** : Air, water, agricultural spray solutions, and other dilute chemicals Excellent resistance to heat and weathering Also resists animal fats, vegetable oils.
- Cover** : Smooth red abrasion and weather resistant EPDM synthetic rubber
- Reinforcement** : Multiple layers of synthetic yarn
- Tube** : Synthetic oil mist resistant EPDM synthetic rubber
- Temperature** : -30C to +93C(-20F to +200F)

Rubber Material Handling Hose

	Nom. I.D	Nom. O.D	PSI	Weight (lbs)	Std Pack Qty	Part #
	1/4"	0.55"	250	0.13	300'	GPE-025-250
	5/16"	0.63"	250	0.16	300'	GPE-031-250
	3/8"	0.68"	150	0.15	300'	GPE-038-150
Food Hose	3/8"	0.67"	200	0.16	300'	GPE-038-200
Ducting	3/8"	0.71"	250	0.19	300'	GPE-038-250
	1/2"	0.83"	200	0.23	300'	GPE-050-200
Auto Truck and Marine Hose	1/2"	0.87"	250	0.27	300'	GPE-050-250
	5/8"	0.98"	250	0.31	300'	GPE-063-250
Fire Hose	3/4"	1.16"	250	0.42	300'	GPE-075-250
Welding and Other Hose	1"	1.42"	200	0.55	300'	GPE-100-200
	1-1/4"	1.77"	150	0.62	100'	GPE-125-150
Cam and Groove	1-1/2"	2.00"	150	0.73	100'	GPE-150-150
	2"	2.50"	150	1.10	100'	GPE-200-150

Cut Lengths : Plus 5%

Standard Lengths : 1/4"- 1" 50'/100'/300' reels approx, 1-1/4" - 1-1/2" 50'/100'/400'/500' reels approx, 2" 50'/100'/300' reels approx

Recommended Couplings : High Pressure 1" - 1-1/2" for air service if the working pressure exceeds 150 psi. High Pressure, Short shank, universal, or Combination nipples all other sizes.

Clamps

High Pressure Fittings

Mine Fittings

Air Fittings

Valves

Sandblast

Fire Fittings

Pipe Fittings

Sheet Rubber

Index and Technical Information

PREMIUM GENERAL PURPOSE - NON CONDUCTIVE



- Application** : A premium quality long length hose for petroleum based fluids, lubricating oils, air, hot water and some chemical solutions
- Cover** : Red, oil, grease, weather and abrasion resistant nitrile
- Reinforcement** : Multiple layers of synthetic yarn
- Tube** : Black oil resistant nitrile rubber
- Temperature** : -32C to +85C (-25F to +185F)

Nom. I.D	Nom. O.D	PSI	Weight (lbs)	Std Pack Qty	Part #
1/4"	0.51"	300	0.12	300'	PREM-025-300
3/8"	0.67"	300	0.17	300'	PREM-038-300
1/2"	0.79"	300	0.21	300'	PREM-050-300
3/4"	1.14"	300	0.43	300'	PREM-075-300
1"	1.42"	300	0.60	300'	PREM-100-300
1-1/4"	1.77"	250	0.70	100'	PREM-125-250
1-1/2"	2.05"	250	0.87	100'	PREM-150-250

Cut Lengths : Plus 5%

Standard Lengths : 1/4" - 1" 50'/300' reels approx, 1-1/4" - 1-1/2" 50'/100'

Recommended Couplings : High Pressure 1" - 1-1/2" for air service if the working pressure exceeds 150 psi. High Pressure, Short shank, universal, or Combination nipples all other sizes.

ARCTIC SUPERFLEX GENERAL PURPOSE



- Application** : A premium general purpose hose for conveying air, water, petroleum products and some chemicals under arctic conditions
- Cover** : Blue weather and oil resistant synthetic rubber specially compounded for arctic service.
- Reinforcement** : Multiple layers of synthetic yarn with static wire
- Tube** : Black oil and fuel resistant nitrile rubber specially compounded for arctic service.
- Temperature** : -54C to +90C (-65F to +195F)

Nom. I.D	Nom. O.D	PSI	Weight (lbs)	Std Pack Qty	Part #
1/2"	0.84"	300	0.35	300'	GPA-050
3/4"	1.12"	300	0.45	300'	GPA-075
1"	1.47"	300	0.60	300'	GPA-100
1-1/4"	1.78"	300	0.71	200'	GPA-125
1-1/2"	2.03"	300	0.95	200'	GPA-150
2"	2.50"	300	1.25	200'	GPA-200

Cut Lengths : Plus 10%

Standard Lengths : 300' 1/2" - 1" smooth cover, 200' 1-1/4" - 2" wrapped impression cover

Recommended Couplings : High Pressure, mine stem and nut

Air and General Purpose Hose

Water Suction and Discharge Hose

Petroleum, Steam and Chemical Hose

Rubber Material Handling Hose

Plastic Material Handling Hose

Food Hose

Ducting

Auto Truck and Marine Hose

Fire Hose

Welding and Other Hose

Cam and Groove

Nipples Menders and Shank Fittings

Clamps

High Pressure Fittings

Mine Fittings

Air Fittings

Valves

Sandblast

Fire Fittings

Pipe Fittings

Sheet Rubber

Index and Technical Information

Air and General Purpose Hose

PUSH - ON BLACK

Water Suction and Discharge Hose



Application

: Transmission of most petroleum-based hydraulic fluids, mineral oil, diesel fuel, engine coolant solutions, agricultural sprays and a wide range of chemical solutions. Also suitable for air and water service

Cover

: Black, oil, weather and abrasion resistant Neoprene.

Reinforcement

: Multiple layers of polyester yarns.

Tube

: Black oil resistant nitrile rubber.

Temperature

: -32C to +80C(-25F to +180F)

Nom. I.D	Nom. O.D	PSI	Weight (lbs)	Std Pack Qty	Part #
1/4"	0.50"	250	0.10	500'	PON-025-B
3/8"	0.63"	250	0.14	500'	PON-038-B
1/2"	0.75"	250	0.17	500'	PON-050-B
5/8"	0.91"	250	0.19	500'	PON-063-B
3/4"	1.03"	250	0.19	500'	PON-075-B

Cut Lengths : Plus 5%

Standard Lengths : Supplied on reels

Recommended Couplings : Push-on

Petroleum, Steam and Chemical Hose

Rubber Material Handling Hose

Plastic Material Handling Hose

Food Hose

Ducting

Auto Truck and Marine Hose

Fire Hose

Welding and Other Hose

Cam and Groove

Nipples, Menders and Shank Fittings

Clamps

High Pressure Fittings

Mine Fittings

Air Fittings

Valves

Sandblast

Fire Fittings

Pipe Fittings

Sheet Rubber

Index and Technical Information

PUSH - ON GREEN



Nom. I.D	Nom. O.D	PSI	Weight (lbs)	Std Pack Qty	Part #
1/4"	0.50"	250	0.10	700'	PON-025-GR
3/8"	0.63"	250	0.14	700'	PON-038-GR

PUSH - ON BLUE



Nom. I.D	Nom. O.D	PSI	Weight (lbs)	Std Pack Qty	Part #
1/4"	0.50"	250	0.10	500'	PON-025-BL
3/8"	0.63"	250	0.14	500'	PON-038-BL
1/2"	0.75"	250	0.17	500'	PON-050-BL
3/4"	1.03"	300	0.19	500'	PON-075-BL

PUSH - ON GREY



Nom. I.D	Nom. O.D	PSI	Weight (lbs)	Std Pack Qty	Part #
1/4"	0.50"	250	0.10	700'	PON-025-G
3/8"	0.63"	250	0.14	700'	PON-038-G
1/2"	0.75"	250	0.17	700'	PON-050-G

Air and General Purpose Hose

Water Suction and Discharge Hose

Petroleum, Steam and Chemical Hose

Rubber Material Handling Hose

Plastic Material Handling Hose

Food Hose

Ducting

Auto Truck and Marine Hose

Fire Hose

Welding and Other Hose

Cam and Groove

Nipples Menders and Shank Fittings

Clamps

High Pressure Fittings

Mine Fittings

Air Fittings

Valves

Sandblast

Fire Fittings

Pipe Fittings

Sheet Rubber

Index and Technical Information

PUSH - ON RED



Nom. I.D	Nom. O.D	PSI	Weight (lbs)	Std Pack Qty	Part #
1/4"	0.50"	250	0.10	500'	PON-025-R
3/8"	0.63"	250	0.14	500'	PON-038-R
1/2"	0.75"	250	0.17	500'	PON-050-R
3/4"	1.03"	300	0.19	500'	PON-075-R

PUSH - ON YELLOW



Nom. I.D	Nom. O.D	PSI	Weight (lbs)	Std Pack Qty	Part #
1/4"	0.50"	250	0.10	700'	PON-025-Y
3/8"	0.63"	250	0.14	700'	PON-038-Y
1/2"	0.75"	250	0.17	700'	PON-050-Y

Air and General Purpose Hose

Water Suction and Discharge Hose

Petroleum, Steam and Chemical Hose

Rubber Material Handling Hose

Plastic Material Handling Hose

Food Hose

Ducting

Auto Truck and Marine Hose

Fire Hose

Welding and Other Hose

Cam and Groove

Nipples Menders and Shank Fittings

Clamps

High Pressure Fittings

Mine Fittings

Air Fittings

Valves

Sandblast

Fire Fittings

Pipe Fittings

Sheet Rubber

Index and Technical Information

SELF-STORING AIR-URETHANE ASSEMBLY



Cover : Blue polyurethane, highly kink and abrasion and flex resistant. Superior in every way to regular nylon self storing hose.

Temperature : -40C to +77C(-40F to +170F)

Description	PSI	Weight (lbs)	Part #
1/4"X10'URETHANE SELF STORING ASSY	120	.5	SSU-025-10ASS
1/4"X15'URETHANE SELF STORING ASSY	120	0.7	SSU-025-15ASS
1/4"X20'URETHANE SELF STORING ASSY	120	0.9	SSU-025-20ASS
1/4"X25'URETHANE SELF STORING ASSY	120	1	SSU-025-25ASS
1/4"X50'URETHANE SELF STORING ASSY	120	2.0	SSU-025-50ASS
3/8"X10'URETHANE SELF STORING ASSY	100	1.2	SSU-038-10ASS
3/8"X15'URETHANE SELF STORING ASSY	100	1.4	SSU-038-15ASS
3/8"X20'URETHANE SELF STORING ASSY	100	1.6	SSU-038-20ASS
3/8"X25'URETHANE SELF STORING ASSY	100	1.8	SSU-038-25ASS
3/8"X50'URETHANE SELF STORING ASSY	100	3.5	SSU-038-50ASS
1/2"X25'URETHANE SELF STORING ASSY	100	3.25	SSU-050-25ASS
1/2"X50'URETHANE SELF STORING ASSY	100	5.5	SSU-050-50ASS

SELF-STORING AIR-NYLON

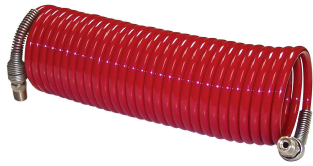

Air and General Purpose Hose

Water Suction and Discharge Hose

Petroleum, Steam and Chemical Hose

Rubber Material Handling Hose

Plastic Material Handling Hose

Food Hose

Ducting

Auto Truck and Marine Hose

Fire Hose

Welding and Other Hose

Cam and Groove

Nipples Menders and Shank Fittings

Clamps

High Pressure Fittings

Mine Fittings

Air Fittings

Valves

Sandblast

Fire Fittings

Pipe Fittings

Sheet Rubber

Index and Technical Information

Cover : Red nylon elastomer, resistant to oils, hydraulic fluids and many other contaminants. Retractability 30:1. To obtain extended hose length required, multiply distance from air supply by 1.3.

Temperature : -40C to +77C(-40F to +170F)

Description	PSI	Weight (lbs)	Part #
1/4"X12.5'SELF-STOR ASSY	200	0.31	SSA-025-12
1/4"X25' SELF-STOR ASSY	200	0.56	SSA-025-25
1/4" X 50' SELF-STOR ASSY	200	1.06	SSA-025-50
1/4" X 75' SELF-STOR ASSY	200	1.56	SSA-025-75
1/4" X 100' SELF-STOR ASSY	200	2.06	SSA-025-100
3/8" X 12.5' SELF-STOR ASSY	200	0.46	SSA-038-12
3/8" X 25' SELF-STOR ASSY	200	0.83	SSA-038-25
3/8" X 50' SELF-STOR ASSY	200	1.58	SSA-038-50
3/8" X 75' SELF-STOR ASSY	200	2.33	SSA-038-75
3/8" X 100' SELF-STOR ASSY	200	3.08	SSA-038-100
1/2" X 12.5' SELF-STOR ASSY	150	0.89	SSA-050-12
1/2" X 25' SELF-STOR ASSY	150	1.64	SSA-050-25
1/2" X 50' SELF-STOR ASSY	150	3.14	SSA-050-50
1/2" X 75' SELF-STOR ASSY	150	4.92	SSA-050-75
1/2" X 100' SELF-STOR ASSY	150	6.14	SSA-050-100
1/4" SELF-STOR AIR	200	0.02	SSA-025
3/8" SELF-STOR AIR	200	0.03	SSA-038
1/2" SELF-STOR AIR	150	0.06	SSA-050
3/4" SELF-STOR AIR	125	0.09	SSA-075
1/4" SELF-STOR MALE SWIVEL	200	0.03	SSA-025-FIT
3/8" SELF-STOR MALE SWIVEL	200	0.04	SSA-038-FIT
1/2" SELF-STOR MALE SWIVEL	150	0.07	SSA-050-FIT
3/4" SELF-STOR MALE SWIVEL	125	0.10	SSA-075-FIT

Cut Lengths : P.O.A

Standard Lengths : 100'

Air and General Purpose Hose

Water Suction and Discharge Hose

Petroleum, Steam and Chemical Hose

Rubber Material Handling Hose

Plastic Material Handling Hose

Food Hose

Ducting

Auto Truck and Marine Hose

Fire Hose

Welding and Other Hose

Cam and Groove

Nipples Menders and Shank Fittings

Clamps

High Pressure Fittings

Mine Fittings

Air Fittings

Valves

Sandblast

Fire Fittings

Pipe Fittings

Sheet Rubber

Index and Technical Information

BLUE LAYFLAT



Application : A light duty layflat hose for portable pump and irrigation use.
Cover : Blue PVC impregnation.
Reinforcement : Woven high tensile synthetic yarns.
Tube : Blue PVC impregnation.
Temperature : -10C to +55C(15F to +130F)

Nom. I.D	Nom. O.D	PSI	Weight (lbs)	Std Pack Qty	Part #
3/4"	0.95"	150	0.11	300'	BLAY-075
1"	1.11"	150	0.13	300'	BLAY-100
1-1/4"	1.37"	130	0.15	300'	BLAY-125
1-1/2"	1.63"	70	0.15	300'	BLAY-150
2"	2.13"	65	0.20	300'	BLAY-200
2-1/2"	2.63"	65	0.27	300'	BLAY-250
3"	3.13"	60	0.33	300'	BLAY-300
4"	4.14"	60	0.46	300'	BLAY-400
5"	5.15"	45	0.65	300'	BLAY-500
6"	6.15"	35	0.78	300'	BLAY-600
8"	8.16"	35	1.22	300'	BLAY-800
10"	10.20"	35	1.75	300'	BLAY-1000
12"	12.30"	30	2.50	300'	BLAY-1200

Cut Lengths : Plus 10%
Standard Lengths : Multiples of 50' up to 300' maximum
Safety Information : Reduce pressures by 50% at maximum working temperature
Recommended Couplings : Cam and groove or short shank

Air and General Purpose Hose

Water Suction and Discharge Hose

Petroleum, Steam and Chemical Hose

Rubber Material Handling Hose

Plastic Material Handling Hose

Food Hose

Ducting

Auto Truck and Marine Hose

Fire Hose

Welding and Other Hose

Cam and Groove

Nipples, Menders and Shank Fittings

Clamps

High Pressure Fittings

Mine Fittings

Air Fittings

Valves

Sandblast

Fire Fittings

Pipe Fittings

Sheet Rubber

Index and Technical Information

BROWN LAYFLAT



- Application** : Heavy duty layflat hose for portable pump and irrigation use.
- Cover** : Brown PVC impregnation.
- Reinforcement** : Woven high tensile synthetic yarns.
- Tube** : Brown heavy PVC impregnation.
- Temperature** : -10C to +60C(15F to +140F)

	Nom. I.D	Nom. O.D	PSI	Weight (lbs)	Std Pack Qty	Part #
	1-1/2"	1.66"	130	0.20	300'	BRLAY-150
	2"	2.16"	115	0.28	300'	BRLAY-200
	2-1/2"	2.73"	100	0.37	300'	BRLAY-250
	3"	3.18"	100	0.46	300'	BRLAY-300
	4"	4.18"	90	0.68	300'	BRLAY-400
	6"	6.18"	70	1.10	300'	BRLAY-600
	8"	8.19"	60	1.66	300'	BRLAY-800

Cut Lengths : Plus 10%

Standard Lengths : Multiples of 50' up to 300' maximum

Safety Information : Reduce pressures by 50% at maximum working temperature

Recommended Couplings : Cam and groove or short shank

GREEN LAYFLAT



- Application** : Heavy duty layflat hose for portable pump and irrigation use.
- Cover** : Green PVC impregnation.
- Reinforcement** : Woven high tensile synthetic yarns.
- Tube** : Green heavy PVC impregnation.
- Temperature** : -10C to +60C(15F to +140F)

	Nom. I.D	Nom. O.D	PSI	Weight (lbs)	Std Pack Qty	Part #
	1-1/2"	1.75"	85	0.17	300'	GRLAY-150
	2"	2.13"	80	0.23	300'	GRLAY-200
	3"	3.13"	75	0.38	300'	GRLAY-300
	4"	4.14"	75	0.53	300'	GRLAY-400
	6"	6.28"	60	1.00	300'	GRLAY-600

Cut Lengths : Plus 10%

Standard Lengths : Multiples of 50' up to 300' maximum

Safety Information : Reduce pressures by 50% at maximum working temperature

Recommended Couplings : Cam and groove or short shank

OROFLEX - PREMIUM RUBBER LAYFLAT

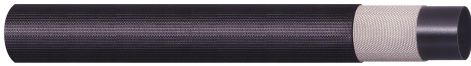

Application : The Original and often copied premium rubber layflat hose. It is a lightweight high pressure, extremely strong hose for general water discharge, and for some chemicals. Its lightweight compact characteristics make this an ideal hose for use with portable pumps

Cover : Black abrasion, weather and oil resistant nitrile rubber.

Reinforcement : Circular woven polyester yarns.

Tube : Black abrasion and oil resistant nitrile rubber.

Temperature : -20C to +80C(0F to +180F)

Nom. I.D	Nom. O.D	PSI	Weight (lbs)	Std Pack Qty	Part #
1-1/2"	1.78"	200	0.21	200'	ORO10-150
2"	2.28"	200	0.30	200'	ORO10-200
2-1/2"	2.78"	175	0.42	200'	ORO10-250
3"	3.32"	175	0.46	200'	ORO10-300
4"	4.32"	150	0.64	200'	ORO10-400
6"	6.36"	150	1.11	200'	ORO10-600
8"	8.36"	150	1.51	200'	ORO10-800

Cut Lengths : Plus 10%

Standard Lengths : 50'/100'/200'/660' on request

Safety Information : Not suitable for petroleum products having an aromatic content over 30%. Not suitable for compressed air service

Recommended Couplings : Cam and groove or short shank

Air and General Purpose Hose

Water Suction and Discharge Hose

Petroleum, Steam and Chemical Hose

Rubber Material Handling Hose

Plastic Material Handling Hose

Food Hose

Ducting

Auto Truck and Marine Hose

Fire Hose

Welding and Other Hose

Cam and Groove

Nipples Menders and Shank Fittings

Clamps

High Pressure Fittings

Mine Fittings

Air Fittings

Valves

Sandblast

Fire Fittings

Pipe Fittings

Sheet Rubber

Index and Technical Information

Air and General Purpose Hose

Water Suction and Discharge Hose

Petroleum, Steam and Chemical Hose

Rubber Material Handling Hose

Plastic Material Handling Hose

Food Hose

Ducting

Auto Truck and Marine Hose

Fire Hose

Welding and Other Hose

Cam and Groove

Nipples, Menders and Shank Fittings

Clamps

High Pressure Fittings

Mine Fittings

Air Fittings

Valves

Sandblast

Fire Fittings

Pipe Fittings

Sheet Rubber

Index and Technical Information

DURAFLEX - RUBBER LAYFLAT

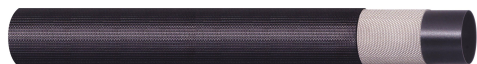

Application

: Specifically manufactured to compete with OROFLEX imitation hose. This is a lightweight high pressure, extremely strong hose for general water discharge service. Ideal for rental service where long life and competitive pricing is paramount. Its compact characteristics make this an ideal hose for use with portable pumps. Especially suited for pumping oily contaminated water.

Cover

: Black abrasion, weather and oil resistant nitrile rubber.

Reinforcement

: Circular woven synthetic yarns.

Tube

: Black abrasion and oil resistant nitrile rubber.

Temperature

: -20C to +80C(0F to +180F)

	Nom. I.D	Nom. O.D	PSI	Weight (lbs)	Std Pack Qty	Part #
	2"	2.26"	200	0.24	100'	DURFL-200
	3"	3.26"	150	0.35	100'	DURFL-300

Cut Lengths : Plus 10%

Standard Lengths : 50'/100'

Safety Information : Not suitable for petroleum products with aromatic content over 30%. Not suitable for compressed air service

Recommended Couplings : Cam and groove or short shank

CONTRACTORS WATER DISCHARGE - GARDEN HOSE

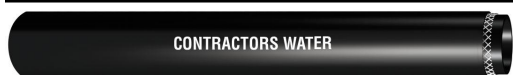

Application

: For use on construction sites and general water service

Cover

: Black abrasion and weather resistant synthetic rubber.

Reinforcement

: Multiple layers of synthetic yarns.

Tube

: Black synthetic rubber compounded for water service.

Temperature

: -35C to +80C(-30F to +180F)

	Nom. I.D	Nom. O.D	PSI	Weight (lbs)	Std Pack Qty	Part #
High Pressure Fittings	1/2"	0.78"	200	0.19	300'	CWB-050-200
Mine Fittings	1/2"	0.84"	250	0.22	300'	CWB-050-250
	5/8"	0.94"	200	0.29	300'	CWB-063-200
Air Fittings	3/4"	1.08"	150	0.32	300'	CWB-075-150
Valves	3/4"	1.14"	250	0.35	300'	CWB-075-250
Sandblast	3/4"	1.14"	300	0.35	300'	CWB-075-300
Fire Fittings	1"	1.40"	150	0.44	100'	CWB-100-150

Cut Lengths : Plus 5%

Standard Lengths : 50'/100'/300' reels

Recommended Couplings : Brass barbed attached with crimped on ferrules

CONTRACTORS WATER DISCHARGE

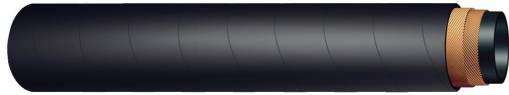

- Application** : A lightweight water discharge hose which is ideal for use with portable pumps, and general water discharge service
- Cover** : Black abrasion and weather resistant synthetic rubber.
- Reinforcement** : Two plies of polyester yarns.
- Tube** : Black synthetic rubber compounded for water service.
- Temperature** : -35C to +80C(-30F to +180F)

Nom. I.D	Nom. O.D	PSI	Weight (lbs)	Std Pack Qty	Part #
1-1/4"	1.50"	100	0.34	100'	CWB-125
1-1/2"	1.73"	100	0.39	100'	CWB-150
2"	2.24"	100	0.51	100'	CWB-200
2-1/2"	2.76"	75	0.72	100'	CWB-250
3"	3.27"	75	0.86	100'	CWB-300
4"	4.29"	75	1.02	100'	CWB-400
6"	6.30"	75	1.77	100'	CWB-600

Cut Lengths : Plus 10%

Standard Lengths : 50'/100'

Recommended Couplings : Cam and groove or short shank

PAPERMILL WASHDOWN



- Application** : Suitable for hot or cold water washdown service in paper mills. Hose incorporates an integral built-in tapered rubber nozzle.
- Cover** : Green abrasion resistant synthetic rubber.
- Reinforcement** : Multiple layers of moisture resistant yarn.
- Tube** : Black synthetic heat resistant rubber.
- Temperature** : -35C to +80C(-30F to +180F)

Nom. I.D	Nom. O.D	PSI	Weight (lbs)	Part #
1/2"	0.94"	250	22.00	PWG-050
3/4"	1.26"	250	22.00	PWG-075
1"	1.50"	250	30.00	PWG-100
1-1/4"	1.77"	250	40.00	PWG-125
1-1/2"	2.09"	250	43.00	PWG-150

Standard Lengths : 50' c/w built-on nozzle.

Recommended Couplings : Long or short shank

Air and General Purpose Hose

Water Suction and Discharge Hose

Petroleum, Steam and Chemical Hose

Rubber Material Handling Hose

Plastic Material Handling Hose

Food Hose

Ducting

Auto Truck and Marine Hose

Fire Hose

Welding and Other Hose

Cam and Groove

Nipples and Shank Fittings

Clamps

High Pressure Fittings

Mine Fittings

Air Fittings

Valves

Sandblast

Fire Fittings

Pipe Fittings

Sheet Rubber

Index and Technical Information

Air and General Purpose Hose

Water Suction and Discharge Hose

Petroleum, Steam and Chemical Hose

Rubber Material Handling Hose

Plastic Material Handling Hose

Food Hose

Ducting

Auto Truck and Marine Hose

Fire Hose

Welding and Other Hose

Cam and Groove

Nipples, Menders and Shank Fittings

Clamps

High Pressure Fittings

Mine Fittings

Air Fittings

Valves

Sandblast

Fire Fittings

Pipe Fittings

Sheet Rubber

Index and Technical Information

CONTRACTORS PLUS WATER DISCHARGE

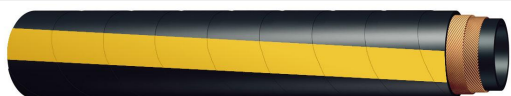

- Application** : A Medium duty water discharge hose for use on construction sites and general water service
- Cover** : Black abrasion and weather resistant synthetic rubber.
- Reinforcement** : Multiple layers of synthetic yarns.
- Tube** : Black synthetic rubber compounded for water service.
- Temperature** : -35C to +80C(-30F to +180F)

	Nom. I.D	Nom. O.D	PSI	Weight (lbs)	Std Pack Qty	Part #
	1-1/4"	1.57"	100	0.38	100'	CWBY-125
	1-1/2"	1.81"	100	0.52	100'	CWBY-150
	2"	2.32"	100	0.69	100'	CWBY-200
	2-1/2"	2.79"	100	0.72	100'	CWBY-250
	3"	3.35"	100	0.99	100'	CWBY-300
	4"	4.33"	100	1.21	100'	CWBY-400
	6"	6.38"	100	2.28	100'	CWBY-600
	8"	8.38"	75	3.47	100'	CWBY-800
	10"	10.43"	75	4.58	50'	CWBY-1000
	12"	12.52"	75	5.56	50'	CWBY-1200

Cut Lengths : Plus 10%

Standard Lengths : 50'/100'

Recommended Couplings : Cam and groove or short shank

PACKERS WASHDOWN



- Application** : A mandrel built hose for wash-down service in breweries, dairies, packing houses, fish processing plants and canneries. Suitable for room temperature washdown only, when used in areas where the cover will be in contact with animal fats and vegetable
- Cover** : Green, heat and oil resistant synthetic rubber cover.
- Reinforcement** : Two layers of synthetic yarns.
- Tube** : Black heat resistant synthetic rubber.
- Temperature** : -32C to +88C(-25F to 190F)

	Nom. I.D	Nom. O.D	PSI	Weight (lbs)	Std Pack Qty	Part #
	1/2"	0.92"	250	0.28	100'	PACK-050-100
	3/4"	1.26"	250	0.44	100'	PACK-075-100
	3/4"	1.26"	250	0.44	75'	PACK-075-75
	1"	1.50"	250	0.60	100'	PACK-100-100

Cut Lengths : Plus 10%

Standard Lengths : 50'/100'

Recommended Couplings : Long or short shank

HEAVY DUTY WATER DISCHARGE/LOW PRESSURE AIR

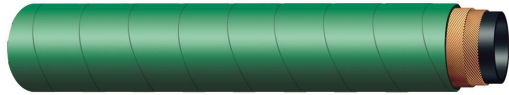

- Application** : A heavy duty hose for water discharge, and light duty air service up to 100 psi for sizes up to 2" only.
- Cover** : Green abrasion and weather resistant synthetic rubber.
- Reinforcement** : Multiple layers of synthetic yarn.
- Tube** : Black synthetic rubber compounded for water service.
- Temperature** : -35C to +80C(-30F to +180F)

Nom. I.D	Nom. O.D	PSI	Weight (lbs)	Std Pack Qty	Part #
1-1/4"	1.65"	150	0.61	100'	HDWG-125
1-1/2"	1.95"	150	0.79	100'	HDWG-150
2"	2.52"	150	1.25	100'	HDWG-200
2-1/2"	2.99"	150	1.44	100'	HDWG-250
3"	3.50"	125	1.78	100'	HDWG-300
4"	4.50"	125	2.51	100'	HDWG-400
5"	5.50"	125	2.40	100'	HDWG-500
6"	6.49"	125	4.29	100'	HDWG-600
8"	8.58"	125	5.06	100'	HDWG-800
10"	10.67"	125	6.27	50'	HDWG-1000
12"	12.67"	100	6.30	50'	HDWG-1200

Cut Lengths : Plus 10%

Standard Lengths : 50'/100'

Recommended Couplings : Cam and groove or short shank

SUPREME WHITE SANITARY



- Application** : For general clean-up and hot water washdown service in dairies, creameries, meat packing houses, food processing and bottling plants. Mandrel built with premium materials to give longer service life at high temperatures.
- Cover** : Heat and abrasion resistant white EPDM synthetic rubber.
- Reinforcement** : Two layers of synthetic yarns, fungus and mould resistant.
- Tube** : White heat resistant EPDM synthetic rubber.
- Temperature** : -40C to +93C(-40F to +200F)

Nom. I.D	Nom. O.D	PSI	Weight (lbs)	Std Pack Qty	Part #
1/2"	1.00"	150	0.30	100'	SWS-050
3/4"	1.26"	150	0.43	100'	SWS-075
1"	1.50"	150	0.50	100'	SWS-100

Cut Lengths : Plus 10%

Standard Lengths : 50'/100'

Recommended Couplings : Long shank or high pressure

Air and General Purpose Hose

Water Suction and Discharge Hose

Petroleum, Steam and Chemical Hose

Rubber Material Handling Hose

Plastic Material Handling Hose

Food Hose

Ducting

Auto Truck and Marine Hose

Fire Hose

Welding and Other Hose

Cam and Groove

Nipples Menders and Shank Fittings

Clamps

High Pressure Fittings

Mine Fittings

Air Fittings

Valves

Sandblast

Fire Fittings

Pipe Fittings

Sheet Rubber

Index and Technical Information

Air and General Purpose Hose

Water Suction and Discharge Hose

Petroleum, Steam and Chemical Hose

Rubber Material Handling Hose

Plastic Material Handling Hose

Food Hose

Ducting

Auto Truck and Marine Hose

Fire Hose

Welding and Other Hose

Cam and Groove

Nipples, Menders and Shank Fittings

Clamps

High Pressure Fittings

Mine Fittings

Air Fittings

Valves

Sandblast

Fire Fittings

Pipe Fittings

Sheet Rubber

Index and Technical Information

HIGH PRESSURE CONTRACTORS WATER DISCHARGE

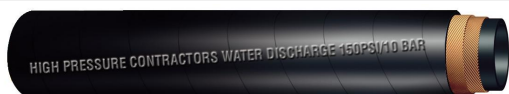

- Application** : For use on construction sites and general water service. High pressure allows pumping against greater vertical heads
- Cover** : Black abrasion and weather resistant synthetic rubber, with embossed brand and pressure.
- Reinforcement Tube** : Multiple layers of synthetic yarn.
: Black synthetic rubber compounded for water service.
- Temperature** : -35C to +80C(-30F to +180F)

	Nom. I.D	Nom. O.D	PSI	Weight (lbs)	Std Pack Qty	Part #
	1-1/4"	1.54"	150	0.37	100'	HPCWB-125
	1-1/2"	1.77"	150	0.43	100'	HPCWB-150
	2"	2.28"	150	0.48	100'	HPCWB-200
	2-1/2"	2.79"	150	0.76	100'	HPCWB-250
	3"	3.35"	150	1.08	100'	HPCWB-300
	4"	4.37"	150	1.38	100'	HPCWB-400
	6"	6.46"	150	2.62	100'	HPCWB-600
	8"	8.54"	150	4.20	100'	HPCWB-800
	10"	10.55"	150	5.78	50'	HPCWB-1000

Cut Lengths : Plus 10%

Standard Lengths : 50'/100'

Recommended Couplings : Cam and groove or short shank

WHITE SANITARY



- Application** : For general clean-up and hot water washdown service in dairies, creameries, meat packing houses, food processing and bottling plants.
- Cover** : White heat and abrasion resistant EPDM synthetic rubber.
- Reinforcement Tube** : Two layers of synthetic yarns, fungus and mould resistant.
: Black heat resistant EPDM synthetic rubber.
- Temperature** : -40C to +93C(-40F to 200F)

	Nom. I.D	Nom. O.D	PSI	Weight (lbs)	Std Pack Qty	Part #
	1/2"	0.91"	250	0.31	300'	SAN-050
	3/4"	1.25"	200	0.54	300'	SAN-075

Cut Lengths : Plus 10%

Standard Lengths : 50'/300' Coils/700' reels

Recommended Couplings : Long Shank or High pressure

SATURN PVC WATER S&D

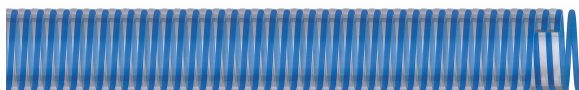

- Application** : An economical, flexible hose for construction pumps, septic tank & marine pump-out service. Resistant to some chemicals, mild acids & alkalis. Consult us for recommendations. Soft compounds allow for increased flexibility
- Cover** : Clear abrasion and weather resistant extra soft PVC.
- Reinforcement** : Blue PVC helix.
- Tube** : Smooth clear extra soft PVC.
- Temperature** : -25C to +65C(-13F to +150F)

Nom. I.D	Nom. O.D	Vacuum (Hg)	Bend Radius	PSI	Weight (lbs)	Std Pack Qty	Part #
3/4"	1.02"	26"	3.00	85	0.20	100'	SAT-075
1"	1.25"	26"	3.00	80	0.25	100'	SAT-100
1-1/4"	1.53"	26"	3.20	70	0.33	100'	SAT-125
1-1/2"	1.83"	24"	3.50	65	0.39	100'	SAT-150
2"	2.35"	24"	5.00	60	0.60	100'	SAT-200
2-1/2"	2.87"	22"	7.00	60	0.80	100'	SAT-250
3"	3.40"	22"	9.00	60	1.00	100'	SAT-300
4"	4.50"	22"	13.00	50	1.60	100'	SAT-400
6"	6.56"	16"	24.00	40	2.90	100'	SAT-600
					3.80		SAT-800

Cut Lengths : Plus 10%

Standard Lengths : 100'

Safety Information : Suction and Pressure ratings are based on a temperature of 20C (68F), reduce by 50% at maximum working temperature

Recommended Couplings : Cam and groove or short shank

Air and General Purpose Hose

Water Suction and Discharge Hose

Petroleum, Steam and Chemical Hose

Rubber Material Handling Hose

Plastic Material Handling Hose

Food Hose

Ducting

Auto Truck and Marine Hose

Fire Hose

Welding and Other Hose

Cam and Groove

Nipples Menders and Shank Fittings

Clamps

High Pressure Fittings

Mine Fittings

Air Fittings

Valves

Sandblast

Fire Fittings

Pipe Fittings

Sheet Rubber

Index and Technical Information

Air and General Purpose Hose

Water Suction and Discharge Hose

Petroleum, Steam and Chemical Hose

Rubber Material Handling Hose

Plastic Material Handling Hose

Food Hose

Ducting

Auto Truck and Marine Hose

Fire Hose

Welding and Other Hose

Cam and Groove

Nipples, Menders and Shank Fittings

Clamps

High Pressure Fittings

Mine Fittings

Air Fittings

Valves

Sandblast

Fire Fittings

Pipe Fittings

Sheet Rubber

Index and Technical Information

SATURN WHITE PVC WATER SUCTION AND DISCHARGE HOSE

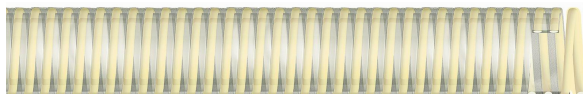

Application

: An economical, flexible hose for construction pumps, septic tank & marine pump-out service. Resistant to some chemicals, mild acids & alkalis. Consult us for recommendations.

Cover

: Clear abrasion and weather resistant PVC.

Reinforcement

: White PVC helix.

Tube

: Smooth clear PVC.

Temperature

: -20C to +65C(-4F to +150F)

	Nom. I.D	Nom. O.D	Vacuum (Hg)	Bend Radius	PSI	Weight (lbs)	Std Pack Qty	Part #
	3/4"	1.02"	28"	3.00"	85	0.20	100'	SATW-075
	1"	1.25"	28"	3.00"	80	0.25	100'	SATW-100
	1-1/4"	1.53"	28"	3.20"	70	0.33	100'	SATW-125
	1-1/2"	1.83"	28"	3.50"	65	0.39	100'	SATW-150
	2"	2.35"	28"	5.00"	60	0.60	100'	SATW-200
	2-1/2"	2.87"	28"	7.00"	60	0.80	100'	SATW-250
	3"	3.40"	28"	9.00"	60	1.00	100'	SATW-300
	4"	4.50"	28"	13.00"	50	1.60	100'	SATW-400
	6"	6.56"	28"	24.00"	40	2.90	100'	SATW-600

Cut Lengths : Plus 10%

Standard Lengths : 100'

Safety Information : Suction and Pressure ratings are based on a temperature of 20C (68F), reduce by 50% at maximum working temperature

Recommended Couplings : Cam and groove or short shank

SUPERFLEX PVC SUCTION

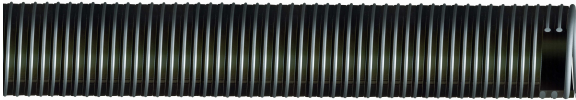

Application : To be used for the cleaning and purging of septic tanks and cesspools. It can also be used in more general applications where great flexibility is required at very low temperatures.

Cover : Black extra soft nitrile/PVC

Reinforcement : Anti shock rigid pvc helix

Tube : Black extra soft nitrile/PVC

Temperature : -40C to +60C(-40F to +140F)

Nom. I.D	Nom. O.D	Vacuum (Hg)	Bend Radius	PSI	Weight (lbs)	Std Pack Qty	Part #
2"	2.39"	20"	3.00"	28	0.60	100'	SUPER-200
3"	3.39"	20"	4.50"	26	1.00	100'	SUPER-300
4"	4.48"	17"	6.50"	20	1.60	100'	SUPER-400
6"	6.57"	17"	8.00"	15	2.90	100'	SUPER-600

Cut Lengths : Plus 10%

Standard Lengths : 100'

Safety Information : Suction and Pressure ratings are based on a temperature of 20C (68F), reduce by 50% at maximum working temperature

Recommended Couplings : Cam and groove or short shank

EPDM WATER SUCTION

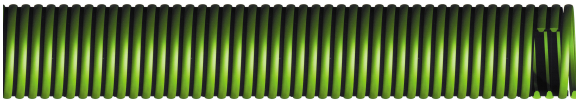

Application : Agricultural suction, general industrial use where high working pressures are not required.

Cover : Green polyethylene and Black EPDM.

Reinforcement : Rigid green polyethylene.

Tube : Smooth EPDM.

Temperature : -35C to +60C(-30F to +140F)

Nom. I.D	Nom. O.D	Vacuum (Hg)	Bend Radius	PSI	Weight (lbs)	Std Pack Qty	Part #
1-1/2"	1.94"	28"	6.00"	60	0.48	100'	EPDM-150
2"	2.50"	28"	9.00"	60	0.71	100'	EPDM-200
3"	3.63"	28"	12.00"	50	1.19	100'	EPDM-300
4"	4.63"	28"	17.00"	45	1.82	100'	EPDM-400
6"	6.88"	28"	27.00"	35	3.50	100'	EPDM-600

Cut Lengths : Plus 10%

Standard Lengths : 100'

Safety Information : Suction and Pressure ratings are based on a temperature of 20C (68F), reduce by 50% at maximum working temperature

Recommended Couplings : Cam and groove or short shank

Air and General Purpose Hose

Water Suction and Discharge Hose

Petroleum, Steam and Chemical Hose

Rubber Material Handling Hose

Plastic Material Handling Hose

Food Hose

Ducting

Auto Truck and Marine Hose

Fire Hose

Welding and Other Hose

Cam and Groove

Nipples, Menders and Shank Fittings

Clamps

High Pressure Fittings

Mine Fittings

Air Fittings

Valves

Sandblast

Fire Fittings

Pipe Fittings

Sheet Rubber

Index and Technical Information

Air and General Purpose Hose

Water Suction and Discharge Hose

Petroleum, Steam and Chemical Hose

Rubber Material Handling Hose

Plastic Material Handling Hose

Food Hose

Ducting

Auto Truck and Marine Hose

Fire Hose

Welding and Other Hose

Cam and Groove

Nipples, Menders and Shank Fittings

Clamps

High Pressure Fittings

Mine Fittings

Air Fittings

Valves

Sandblast

Fire Fittings

Pipe Fittings

Sheet Rubber

Index and Technical Information

HEAVY DUTY PVC WATER S&D

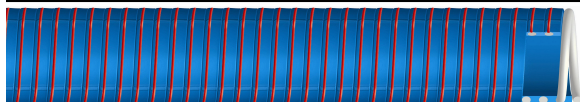

Application : An economical, flexible hose for construction pumps, septic tank and marine pumpout service, mining and quarry use. Resistant to some chemicals, mild acids and alkalis. Consult us for recommendations. Low durometer compounds allow for increased flexibility.

Cover : Blue abrasion and weather resistant extra soft PVC

Reinforcement : Rigid PVC helix

Tube : Smooth Blue extra soft PVC

Temperature : -10C to +65C(15F to +150F)

	Nom. I.D	Nom. O.D	Vacuum (Hg)	Bend Radius	PSI	Weight (lbs)	Std Pack Qty	Part #
	3/4"	1.03"	28"	2.50"	100	0.21	100'	HDPVC-075
	1"	1.28"	28"	3.00"	100	0.26	100'	HDPVC-100
	1-1/4"	1.55"	28"	3.50"	100	0.40	100'	HDPVC-125
	1-1/2"	1.85"	28"	4.00"	100	0.47	100'	HDPVC-150
	2"	2.42"	28"	5.50"	90	0.70	100'	HDPVC-200
	2-1/2"	2.90"	28"	7.00"	80	1.02	100'	HDPVC-250
	3"	3.45"	28"	10.00"	75	1.25	100'	HDPVC-300
	4"	4.55"	28"	14.00"	60	1.90	100'	HDPVC-400
	5"	5.60"	28"	20.00"	55	2.40	100'	HDPVC-500
	6"	6.70"	28"	25.00"	50	3.80	100'	HDPVC-600
	8"	8.86"	26"	33.00"	30	6.80	60'	HDPVC-800

Cut Lengths : Plus 10%

Standard Lengths : 3/4"- 6" 100. 8"- 60'

Safety Information : Suction and Pressure ratings are based on a temperature of 20C (68F), reduce by 50% at maximum working temperature

Recommended Couplings : Cam and groove or short shank

RUBBER WATER S&D



- Application** : A heavy duty wire reinforced rubber suction hose for construction, quarries and general use.
- Cover** : Black smooth abrasion and weather resistant synthetic rubber.
- Reinforcement** : High tensile wire helix embedded between layers of textile cords.
- Tube** : Smooth black synthetic rubber.
- Temperature** : -30C to +80C(-22F to +180F)

Nom. I.D	Nom. O.D	Vacuum (Hg)	Bend Radius	PSI	Weight (lbs)	Std Pack Qty	Part #
3/4"	1.14"	29"	2.00"	200	0.50	100'	WSB-075
1"	1.42"	29"	3.00"	150	0.68	100'	WSB-100
1-1/4"	1.65"	29"	4.00"	150	0.77	100'	WSB-125
1-1/2"	1.93"	29"	4.00"	150	1.00	100'	WSB-150
2"	2.48"	29"	5.00"	150	1.45	100'	WSB-200
2-1/2"	2.99"	29"	8.00"	150	1.84	100'	WSB-250
3"	3.50"	29"	10.00"	150	2.23	100'	WSB-300
4"	4.64"	29"	14.00"	125	3.72	100'	WSB-400
5"	5.67"	29"	20.00"	125	3.90	100'	WSB-500
6"	6.66"	29"	30.00"	125	5.10	100'	WSB-600
8"	8.90"	29"	65.00"	50	8.83	60'	WSB-800
10"	10.90"	29"	80.00"	50	12.00	40'	WSB-1000
12"	12.99"	29"	100.00"	50	18.57	20'	WSB-1200

Cut Lengths : Plus 10%

Standard Lengths : 3/4" to 4" - 50'/100' -- 5" and 6" - 20'/100' -- 8" - 20'/60' -- 10" - 40' -- 12" - 20'

Recommended Couplings : Cam and groove or Short Shank

Air and General Purpose Hose

Water Suction and Discharge Hose

Petroleum, Steam and Chemical Hose

Rubber Material Handling Hose

Plastic Material Handling Hose

Food Hose

Ducting

Auto Truck and Marine Hose

Fire Hose

Welding and Other Hose

Cam and Groove

Nipples Menders and Shank Fittings

Clamps

High Pressure Fittings

Mine Fittings

Air Fittings

Valves

Sandblast

Fire Fittings

Pipe Fittings

Sheet Rubber

Index and Technical Information

TANK TRUCK



- Application** : An all purpose petroleum suction and discharge hose for use with gasoline, kerosene, diesel, oil suspensions and emulsions. May also be used as hydraulic suction and return line.
- Cover** : Black, abrasion, gasoline and oil resistant synthetic rubber with blue stripe and pressure
- Reinforcement** : High tensile wire helix embedded between layers of textile cords.
- Tube** : Black nitrile rubber for maximum oil resistance.
- Temperature** : -35C to +93C(-30F to +200F)

Nom. I.D	Nom. O.D	Vacuum (Hg)	PSI	Bend Radius	Weight (lbs)	Std Pack Qty	Part #
3/4"	1.14"	29"	150	3.00"	0.45	100'	TLB-075
1"	1.42"	29"	150	3.00"	0.62	100'	TLB-100
1-1/4"	1.65"	29"	150	3.50"	0.72	100'	TLB-125
1-1/2"	1.93"	29"	150	4.00"	0.90	100'	TLB-150
1-3/4"	2.24"	29"	150	4.50"	1.20	100'	TLB-175
2"	2.52"	29"	150	4.50"	1.42	100'	TLB-200
2-1/2"	2.99"	29"	150	5.75"	1.72	100'	TLB-250
3"	3.54"	29"	150	7.00"	2.19	100'	TLB-300
4"	4.68"	29"	150	10.00"	3.63	100'	TLB-400
6"	6.89"	29"	150	21.00"	6.91	100'	TLB-600
10"	10.87"	29"	50	75.00"	10.26	20'	TLB-1000

Cut Lengths : Plus 10%
Standard Lengths : 100'
Product Information : Longer lengths available on request. Please check for availability and pricing
Recommended Couplings : Cam and groove

Air and General Purpose Hose

Water Suction and Discharge Hose

Petroleum, Steam and Chemical Hose

Rubber Material Handling Hose

Plastic Material Handling Hose

Food Hose

Ducting

Auto Truck and Marine Hose

Fire Hose

Welding and Other Hose

Cam and Groove

Nipples, Menders and Shank Fittings

Clamps

High Pressure Fittings

Mine Fittings

Air Fittings

Valves

Sandblast

Fire Fittings

Pipe Fittings

Sheet Rubber

Index and Technical Information

SUPER BLACK 250



Application

: An all purpose petroleum suction and discharge hose for use with gasoline, kerosene, diesel, oil suspensions and emulsions up to 250 PSI. May also be used as hydraulic suction and return line.

Cover

: Black, abrasion, gasoline and oil resistant synthetic rubber with blue stripe and pressure

Reinforcement

: High tensile wire helix embedded between layers of textile cords.

Tube

: Black nitrile rubber for maximum oil resistance.

Temperature

: -35C to +93C (-30F to +200F)

	Nom. I.D	Nom. O.D	Vacuum (Hg)	PSI	Bend Radius	Weight (lbs)	Std Pack Qty	Part #
	2"	2.52"	29"	250	5.00"	1.43	100'	TLB250-200
	2-1/2"	2.99"	29"	250	6.00"	1.65	100'	TLB250-250
	3"	3.54"	29"	250	7.00"	2.17	100'	TLB250-300
	4"	4.68"	29"	250	10.00"	3.63	100'	TLB250-400
	6"	6.89"	29"	250	21.00"	7.00	100'	TLB250-600

Cut Lengths : Plus 10%

Standard Lengths : 100'

Product Information : Longer lengths available on request. Please check for availability and pricing

Recommended Couplings : Cam and groove

LW ARCTIC SUPERFLEX 150 PETROLEUM

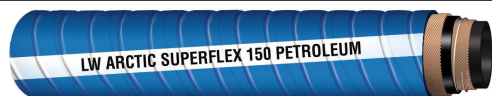

Application

: Specially designed to remain flexible while handling a wide range of petroleum products, including gasoline and diesel under arctic conditions.

Cover

: Blue weather and oil resistant synthetic rubber specially compounded for arctic service. Corrugated with white stripe.

Reinforcement

: High tensile wire helix embedded between layers of textile cords.

Tube

: Black oil and fuel resistant nitrile rubber specially compounded for arctic service.

Temperature

: -54C to +92C (-65F to +200F)

	Nom. I.D	Nom. O.D	Vacuum (Hg)	PSI	Bend Radius	Weight (lbs)	Std Pack Qty	Part #
	1-1/2"	1.95"	29"	150	4.00"	0.89	100'	TTAD-150
	2"	2.56"	29"	150	4.00"	1.33	100'	TTAD-200
	2-1/2"	3.03"	29"	150	5.00"	1.78	100'	TTAD-250
	3"	3.62"	29"	150	6.00"	2.35	100'	TTAD-300
	4"	4.72"	29"	150	9.00"	3.49	100'	TTAD-400
	6"	6.75"	29"	150	20.00"	5.63	100'	TTAD-600

Cut Lengths : Plus 10%

Standard Lengths : 100'

Product Information : Longer lengths available on request. Please check for availability and pricing

Recommended Couplings : Cam and groove

HOT TAR & ASPHALT

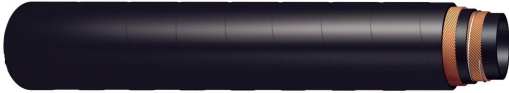

- Application** : Specially designed for conveying hot tar and asphalt at temperatures up to 160 C (350 F).
Cover : Black Neoprene synthetic rubber.
Reinforcement : High tensile wire helix embedded between multiple layers of heat resistant synthetic yarns
Tube Temperature : Specially compounded heat resistant synthetic rubber compound.
: up to +160C(350F)

Nom. I.D	Nom. O.D	PSI	Weight (lbs)	Std Pack Qty	Part #
3"	3.77"	150	2.94	100'	HTA-300
4"	4.85"	150	4.20	100'	HTA-400

- Cut Lengths** : Plus 10%
Standard Lengths : 100'
Recommended Couplings : Cam and groove

H.O.T OIL TANK TRUCK



- Application** : Specially designed for conveying hot oil and/or Glycol at temperatures up to 120C (250 F).
Cover : Black corrugated, abrasion and oil resistant synthetic rubber with red stripe
Reinforcement : High tensile wire helix embedded between layers of textile cords.
Tube Temperature : Specially compounded heat resistant synthetic rubber compound.
: up to +120C(250F)

Nom. I.D	Nom. O.D	Vacuum (Hg)	PSI	Bend Radius	Weight (lbs)	Std Pack Qty	Part #
2"	2.52"	29"	150	5.00"	1.44	100'	TTDHT-200
2-1/2"	3.07"	29"	150	6.00"	1.72	100'	TTDHT-250
3"	3.54"	29"	150	7.00"	2.17	100'	TTDHT-300
4"	4.68"	29"	150	10.00"	3.63	100'	TTDHT-400

- Cut Lengths** : Plus 10%
Standard Lengths : 100'
Product Information : Longer lengths available on request. Please check for availability and pricing
Recommended Couplings : Cam and groove

Air and General Purpose Hose

Water Suction and Discharge Hose

Petroleum, Steam and Chemical Hose

Rubber Material Handling Hose

Plastic Material Handling Hose

Food Hose

Ducting

Auto Truck and Marine Hose

Fire Hose

Welding and Other Hose

Cam and Groove

Nipples, Menders and Shank Fittings

Clamps

High Pressure Fittings

Mine Fittings

Air Fittings

Valves

Sandblast

Fire Fittings

Pipe Fittings

Sheet Rubber

Index and Technical Information

Air and General Purpose Hose

Water Suction and Discharge Hose

Petroleum, Steam and Chemical Hose

Rubber Material Handling Hose

Plastic Material Handling Hose

Food Hose

Ducting

Auto Truck and Marine Hose

Fire Hose

Welding and Other Hose

Cam and Groove

Nipples, Menders and Shank Fittings

Clamps

High Pressure Fittings

Mine Fittings

Air Fittings

Valves

Sandblast

Fire Fittings

Pipe Fittings

Sheet Rubber

Index and Technical Information

TANK TRUCK DROP 5000

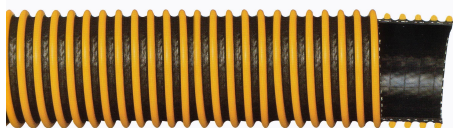

Application : Unloading of gasoline and other fuels under gravity flow
Cover : Corrugated yellow PVC helix
Reinforcement : Multiple layers of synthetic textile cords with copper static wire
Tube : Specially formulated low temperature Nitrile rubber.
Temperature : -22C to +65C(-30F to +150F)

Nom. I.D	Nom. O.D	PSI	Bend Radius	Weight (lbs)	Std Pack Qty	Part #
3"	3.76"	65	4.00"	1.20	100'	DR-300
4"	4.79"	65	4.50"	1.80	100'	DR-400

Cut Lengths : Plus 10%

Standard Lengths : 100'

Recommended Couplings : To properly couple this hose banding sleeves are required. Please consult us for details

TANK TRUCK DROP 5000 BANDING SLEEVE

Description	Nom. I.D	Weight (lbs)	Part #
3"X3'BANDING SLEEVE FOR 5000 DROP	3"	3.71	DRS-300
4"X3'BANDING SLEEVE FOR 5000 DROP	4"	5.31	DRS-400

TANK TRUCK DROP



Application : A lightweight drop hose for gasoline delivery services. Will handle same range of products as Tank Truck.

Cover : Black corrugated, abrasion, oil and gasoline resistant synthetic rubber.

Reinforcement : High tensile wire helix embedded between layers of textile cords.

Tube : Black nitrile rubber for maximum oil resistance.

Temperature : -35C to +93C(-30F to +200F)

Nom. I.D	Nom. O.D	Vacuum (Hg)	PSI	Bend Radius	Weight (lbs)	Std Pack Qty	Part #
2"	2.40"	29"	75	6.00"	0.92	100'	TTDB-200
2-1/2"	2.87"	29"	75	8.00"	1.24	100'	TTDB-250
3"	3.50"	29"	75	9.00"	1.84	100'	TTDB-300
4"	4.57"	29"	75	12.00"	2.58	100'	TTDB-400

Cut Lengths : Plus 10%

Standard Lengths : 50'/100'

Recommended Couplings : Cam and groove

LW PETROLEUM TANK 150



- Application** : An all purpose lightweight and flexible petroleum suction and discharge hose for use with gasoline, kerosene, diesel, oil suspensions and emulsions. May also be used as hydraulic suction and return line.
- Cover** : Black corrugated, abrasion, gasoline and oil resistant synthetic rubber with green stripe.
- Reinforcement Tube** : High tensile wire helix embedded between layers of textile cords.
: Black nitrile rubber for maximum oil resistance.
- Temperature** : -40C to +93C(-40F to +200F)

Nom. I.D	Nom. O.D	Vacuum (Hg)	PSI	Bend Radius	Weight (lbs)	Std Pack Qty	Part #
2"	2.52"	29"	150	4.00"	1.44	100'	TTD150-200
2-1/2"	2.99"	29"	150	5.00"	1.65	100'	TTD150-250
3"	3.54"	29"	150	6.00"	2.17	100'	TTD150-300
4"	4.68"	29"	150	9.00"	3.64	100'	TTD150-400
6"	6.89"	29"	150	20.00"	7.00	100'	TTD150-600

Cut Lengths : Plus 10%

Standard Lengths : 100'

Product Information : Longer lengths available on request. Please check for availability and pricing

Recommended Couplings : Cam and groove

PETROLEUM DISCHARGE



- Application** : For handling a wide range of petroleum products, including gasoline, as well as a number of chemical solutions.
- Cover** : Red, heat, oil and weather resistant Neoprene.
- Reinforcement Tube** : Multiple layers of synthetic textile cords, with static wire.
: Black, heat and oil resistant synthetic rubber.
- Temperature** : -35C to +88C(-30F to +190F)

Nom. I.D	Nom. O.D	PSI	Weight (lbs)	Std Pack Qty	Part #
3/4"	1.22"	200	0.44	100'	PDR-075
1"	1.46"	200	0.44	100'	PDR-100
1-1/4"	1.69"	150	0.58	100'	PDR-125
1-1/2"	1.97"	150	0.78	100'	PDR-150
2"	2.50"	150	1.19	100'	PDR-200
2-1/2"	3.00"	150	1.40	100'	PDR-250
3"	3.50"	150	1.64	100'	PDR-300
4"	4.57"	150	2.46	100'	PDR-400

Cut Lengths : Plus 10%

Standard Lengths : 50'/100'

Recommended Couplings : Cam and groove

Air and General Purpose Hose

Water Suction and Discharge Hose

Petroleum, Steam and Chemical Hose

Rubber Material Handling Hose

Plastic Material Handling Hose

Food Hose

Ducting

Auto Truck and Marine Hose

Fire Hose

Welding and Other Hose

Cam and Groove

Nipples Menders and Shank Fittings

Clamps

High Pressure Fittings

Mine Fittings

Air Fittings

Valves

Sandblast

Fire Fittings

Pipe Fittings

Sheet Rubber

Index and Technical Information

Air and General Purpose Hose

PETROLEUM DISCHARGE 250

Water Suction and Discharge Hose



Petroleum, Steam and Chemical Hose

- Application** : For handling a wide range of petroleum products, including gasoline, as well as a number of chemical solutions.
- Cover** : Black, heat, oil and weather resistant Neoprene.
- Reinforcement** : Multiple layers of synthetic textile cords, with static wire.
- Tube** : Black, heat and oil resistant synthetic rubber.
- Temperature** : -35C to +88C(-30F to +190F)

Rubber Material Handling Hose

	Nom. I.D	Nom. O.D	PSI	Weight (lbs)	Std Pack Qty	Part #
	2"	2.50"	250	1.14	100'	PDB250-200
	2-1/2"	3.03"	250	1.48	100'	PDB250-250
	3"	3.54"	250	1.80	100'	PDB250-300
Food Hose	4"	4.64"	250	2.81	100'	PDB250-400
Ducting	6"	6.69"	250	5.20	100'	PDB250-600

- Cut Lengths** : Plus 10%
- Standard Lengths** : 50'/100'
- Recommended Couplings** : Cam and groove

Plastic Material Handling Hose

Food Hose

Ducting

Auto Truck and Marine Hose

Fire Hose

URETHANE DUST&VAPOUR RECOVERY

Welding and Other Hose

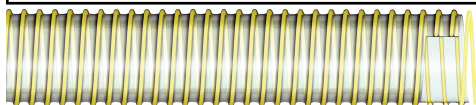

Cam and Groove

- Application** : Vapour recovery from petroleum transfer operations. Embedded static wire serves to dissipate static electricity. NOT SUITABLE FOR CONVEYING LIQUIDS
- Cover** : Convoluted yellow helix
- Reinforcement** : Yellow PVC helix with integral static wire
- Tube** : Clear fuel resistant polyurethane
- Temperature** : -30C to +60C(-25F to +140F)

Nipples, Menders and Shank Fittings

Clamps

	Nom. I.D	Nom. O.D	PSI	Weight (lbs)	Std Pack Qty	Part #
High Pressure Fittings	3"	3.54"	15	0.69	100'	W187-300
Mine Fittings	4"	4.56"	10	0.92	100'	W187-400
Air Fittings	5"	5.51"	8	1.13	100'	W187-500
Valves	6"	6.52"	7	1.24	100'	W187-600

- Cut Lengths** : Plus 10%
- Standard Lengths** : 100'

High Pressure Fittings

Mine Fittings

Air Fittings

Valves

Sandblast

Fire Fittings

Pipe Fittings

Sheet Rubber

Index and Technical Information

AGRICULTURAL FARM TANK 100 PSI



- Application** : Dispense diesel fuel and oil from gravity tanks and barrel pumps.
- Reinforcement** : Multiple layers of synthetic textile yarns with static wire
- Cover** : Black weather and oil resistant synthetic rubber.
- Tube** : Black oil resistant nitrile rubber
- Temperature** : -35C to +80C(-30F to +180F)

Nom. I.D	Nom. O.D	PSI	Weight (lbs)	Std Pack Qty	Part #
3/4"	1.06"	100	0.37	500'	AGP-075-100
1"	1.38"	100	0.54	500'	AGP-100-100

Cut Lengths : Plus 10%
Standard Lengths : 500' reels

SAE 100R4 OIL SUCTION HOSE

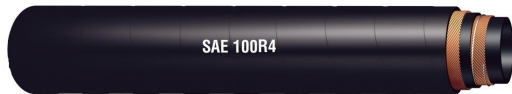

- Application** : A high quality oil suction hose specifically designed for hydraulic suction service.
- Reinforcement** : High tensile wire helix embedded between layers of textile cords.
- Tube** : Black nitrile rubber for maximum oil resistance.

Nom. I.D	Nom. O.D	Vacuum (Hg)	PSI	Bend Radius	Weight (lbs)	Std Pack Qty	Part #
3/4"	1.26"	29"	300	3.00"	0.62	100'	100R4-12
1"	1.50"	29"	250	4.00"	0.74	100'	100R4-16
1-1/4"	1.73"	29"	200	6.00"	1.01	100'	100R4-20
1-1/2"	1.97"	29"	150	7.00"	1.01	100'	100R4-24
2"	2.56"	29"	100	8.00"	1.47	100'	100R4-32
2-1/2"	2.99"	29"	65	10.00"	1.67	100'	100R4-40
3"	3.55"	29"	55	12.00"	2.18	100'	100R4-48
4"	4.56"	29"	35	18.00"	3.10	100'	100R4-64

Cut Lengths : Plus 10%
Standard Lengths : 100'
Recommended Couplings : Swaged hydraulic

Air and General Purpose Hose

Water Suction and Discharge Hose

Petroleum, Steam and Chemical Hose

Rubber Material Handling Hose

Plastic Material Handling Hose

Food Hose

Ducting

Auto Truck and Marine Hose

Fire Hose

Welding and Other Hose

Cam and Groove

Nipples Menders and Shank Fittings

Clamps

High Pressure Fittings

Mine Fittings

Air Fittings

Valves

Sandblast

Fire Fittings

Pipe Fittings

Sheet Rubber

Index and Technical Information

STEAM TEXTILE



- Application** : For use with saturated steam up to 100 PSI, 170C(338F). For thawing, wash-down at papermills and food plants and other applications where a steel reinforced hose is not suitable due to electrical conductivity.
- Cover** : Red, heat, weather and abrasion resistant EPDM synthetic rubber.
- Reinforcement** : Two layers of heat resistant synthetic yarns.
- Tube** : Black heat resistant EPDM synthetic rubber.
- Temperature** : -40C to +170C(-40F to +338F)

Nom. I.D	Nom. O.D	PSI	Weight (lbs)	Std Pack Qty	Part #
1/2"	1.00"	100	0.30	100'	TEX-050
3/4"	1.26"	100	0.44	100'	TEX-075
1"	1.50"	100	0.58	100'	TEX-100
1-1/4"	1.85"	100	0.74	100'	TEX-125
1-1/2"	2.09"	100	0.87	100'	TEX-150
2"	2.64"	100	1.07	100'	TEX-200

Cut Lengths : Plus 10%
Standard Lengths : 50'/100'
Recommended Couplings : High Pressure with interlocking clamps

STEAM 250 CHLOROBUTYL



- Application** : An extremely flexible hose for use with saturated steam at pressures to 250 PSI .
- Cover** : Red abrasion and heat resistant EPDM synthetic rubber.
- Reinforcement** : One wire braid.
- Tube** : Black heat resistant Chlorobutyl synthetic rubber.
- Temperature** : -40C to +210C(-40F to +406F)

Nom. I.D	Nom. O.D	PSI	Weight (lbs)	Std Pack Qty	Part #
1/2"	1.00"	250	0.40	100'	ST250CB-050
3/4"	1.31"	250	0.48	100'	ST250CB-075
1"	1.56"	250	0.59	100'	ST250CB-100
1-1/4"	1.85"	250	0.78	100'	ST250CB-125
1-1/2"	2.13"	250	1.07	100'	ST250CB-150
2"	2.69"	250	1.58	100'	ST250CB-200

Cut Lengths : No Cut Lengths
Standard Lengths : 50'/100'
Recommended Couplings : High Pressure with interlocking clamps

- Air and General Purpose Hose
- Water Suction and Discharge Hose
- Petroleum, Steam and Chemical Hose
- Rubber Material Handling Hose
- Plastic Material Handling Hose
- Food Hose
- Ducting
- Auto Truck and Marine Hose
- Fire Hose
- Welding and Other Hose
- Cam and Groove
- Nipples Menders and Shank Fittings
- Clamps
- High Pressure Fittings
- Mine Fittings
- Air Fittings
- Valves
- Sandblast
- Fire Fittings
- Pipe Fittings
- Sheet Rubber
- Index and Technical Information

Air and General Purpose Hose

Water Suction and Discharge Hose

Petroleum, Steam and Chemical Hose

Rubber Material Handling Hose

Plastic Material Handling Hose

Food Hose

Ducting

Auto Truck and Marine Hose

Fire Hose

Welding and Other Hose

Cam and Groove

Nipples Menders and Shank Fittings

Clamps

High Pressure Fittings

Mine Fittings

Air Fittings

Valves

Sandblast

Fire Fittings

Pipe Fittings

Sheet Rubber

Index and Technical Information

STEAM 250



Application

: An extremely flexible hose for use with saturated steam at pressures to 250 PSI .

Cover

: Red abrasion and heat resistant EPDM rubber, with embossed brand and pressure.

Reinforcement

: Multiple layers of high tensile steel cords.

Tube

: Black heat resistant EPDM synthetic rubber.

Temperature

: -40C to +210C(-40F to +406F)

	Nom. I.D	Nom. O.D	PSI	Weight (lbs)	Std Pack Qty	Part #
Rubber Material Handling Hose	1/2"	0.98"	250	0.36	50'	ST250-050-50
Plastic Material Handling Hose	1/2"	0.98"	250	0.36	100'	ST250-050-100
Food Hose	3/4"	1.26"	250	0.50	50'	ST250-075-50
	3/4"	1.26"	250	0.50	100'	ST250-075-100
Ducting	1"	1.50"	250	0.70	50'	ST250-100-50
	1"	1.50"	250	0.70	100'	ST250-100-100
Auto Truck and Marine Hose	1-1/4"	1.81"	250	1.01	50'	ST250-125-50
	1-1/4"	1.81"	250	1.01	100'	ST250-125-100
Fire Hose	1-1/2"	2.13"	250	1.25	50'	ST250-150-50
	1-1/2"	2.13"	250	1.25	100'	ST250-150-100
Welding and Other Hose	2"	2.64"	250	1.48	50'	ST250-200-50
	2"	2.64"	250	1.48	100'	ST250-200-100
Cam and Groove	2-1/2"	3.22"	250	2.00	100'	ST250-250
	3"	3.78"	250	3.40	100'	ST250-300

Cut Lengths : Plus 10%

Standard Lengths : 50'/100'

Product Information : Longer lengths available on request. Please check for availability and pricing

Recommended Couplings : High Pressure with interlocking clamps

EPR ACID DISCHARGE



- Application** : Resistant to a wide range of chemicals, acids, and alcohols. Contact us for recommendations.
- Cover** : Grey chemical and abrasion resistant EPDM rubber with purple identification stripe.
- Reinforcement** : Multiple layers of synthetic yarn.
- Tube** : White chemical, acid, and heat resistant EPDM rubber.
- Temperature** : -40C to +120C(-40F to +248F)

Nom. I.D	Nom. O.D	PSI	Weight (lbs)	Std Pack Qty	Part #
1"	1.50"	150	0.54	100'	EAD-100
1-1/2"	2.05"	150	0.83	100'	EAD-150
2"	2.68"	150	1.30	100'	EAD-200
2-1/2"	3.20"	150	1.62	100'	EAD-250
3"	3.78"	150	2.10	100'	EAD-300

Cut Lengths : Plus 10%

Standard Lengths : 100'

Recommended Couplings : Cam and groove

EPR ACID SUCTION

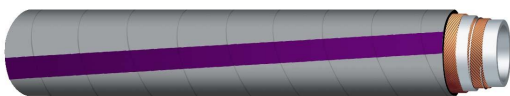

- Application** : Resistant to a wide range of chemicals, acids, and alcohols. Contact us for recommendations.
- Cover** : Grey chemical and abrasion resistant EPDM rubber with purple identification stripe.
- Reinforcement** : High tensile steel wire helix embedded between layers of synthetic yarns.
- Tube** : White chemical, acid, and heat resistant EPDM rubber.
- Temperature** : -40C to +120C(-40F to +248F)

Nom. I.D	Nom. O.D	Vacuum (Hg)	Bend Radius	PSI	Weight (lbs)	Std Pack Qty	Part #
1"	1.50"	28"	7.00"	150	0.56	100'	EAS-100
1-1/2"	2.16"	28"	11.00"	150	1.04	100'	EAS-150
2"	2.68"	28"	14.00"	150	1.54	100'	EAS-200
3"	3.74"	28"	20.00"	150	2.68	100'	EAS-300
4"	4.76"	28"	28.00"	150	4.09	100'	EAS-400

Cut Lengths : Plus 10%

Standard Lengths : 100'

Recommended Couplings : Cam and groove

Air and General Purpose Hose

Water Suction and Discharge Hose

Petroleum, Steam and Chemical Hose

Rubber Material Handling Hose

Plastic Material Handling Hose

Food Hose

Ducting

Auto Truck and Marine Hose

Fire Hose

Welding and Other Hose

Cam and Groove

Nipples, Menders and Shank Fittings

Clamps

High Pressure Fittings

Mine Fittings

Air Fittings

Valves

Sandblast

Fire Fittings

Pipe Fittings

Sheet Rubber

Index and Technical Information

HYPALON ACID DISCHARGE



- Application** : Resistant to a wide range of chemicals, acids, and alcohols. Contact us for recommendations.
- Cover** : Yellow chemical and abrasion resistant nitrile rubber with green identification stripe.
- Reinforcement** : Multiple layers of synthetic yarn
- Tube** : Black chemical resistant Hypalon.
- Temperature** : -32C to +82C(-25F to +180F)

	Nom. I.D	Nom. O.D	PSI	Weight (lbs)	Std Pack Qty	Part #
	3/4"	1.25"	150	0.45	100'	HLD-075
	1"	1.50"	150	0.58	100'	HLD-100
	1-1/2"	2.05"	150	0.90	100'	HLD-150
	2"	2.68"	150	1.40	100'	HLD-200
	3"	3.74"	150	2.45	100'	HLD-300
	4"	4.74"	150	3.20	100'	HLD-400

- Cut Lengths** : Plus 10%
- Standard Lengths** : 100'
- Recommended Couplings** : Cam and groove

HYPALON ACID SUCTION



- Application** : Resistant to a wide range of chemicals, acids, and alcohols. Contact us for recommendations.
- Cover** : Yellow chemical and abrasion resistant nitrile rubber with green identification stripe.
- Reinforcement** : High tensile steel wire helix embedded between layers of synthetic yarns.
- Tube** : Black chemical resistant Hypalon.
- Temperature** : -32C to +82C(-25F to +180F)

	Nom. I.D	Nom. O.D	Vacuum (Hg)	Bend Radius	PSI	Weight (lbs)	Std Pack Qty	Part #
	1"	1.50"	28"	6.00"	150	0.60	100'	HLS-100
	1-1/2"	2.06"	28"	10.00"	150	1.10	100'	HLS-150
	2"	2.68"	28"	12.00"	150	1.70	100'	HLS-200
	3"	3.74"	28"	17.00"	150	3.71	100'	HLS-300

- Cut Lengths** : Plus 10%
- Standard Lengths** : 100'
- Recommended Couplings** : Cam and groove

VITON LINED DISCHARGE



- Application** : For use with extremely corrosive chemicals, highly aromatic fuels, and petroleum based oils at elevated temperature. Contact us for recommendations
- Cover** : Orange chemical and abrasion resistant nitrile rubber with black identification stripe.
- Reinforcement** : Multiple layers of synthetic yarn
- Tube** : Black fuel and chemical resistant Viton.
- Temperature** : -32C to +121C(-25F to +250F)

Nom. I.D	Nom. O.D	PSI	Weight (lbs)	Std Pack Qty	Part #
1/2"	0.95"	150	0.33	100'	VLD-050
3/4"	1.22"	150	0.45	100'	VLD-075
1"	1.48"	150	0.56	100'	VLD-100
1-1/2"	2.00"	150	0.88	100'	VLD-150
2"	2.60"	150	1.30	100'	VLD-200
3"	3.60"	150	2.20	100'	VLD-300

Cut Lengths : Plus 10%

Standard Lengths : 100'

Recommended Couplings : Cam and groove

VITON LINED SUCTION



- Application** : For use with extremely corrosive chemicals, highly aromatic fuels, and petroleum based oils at elevated temperature. Contact us for recommendations
- Cover** : Orange chemical and abrasion resistant nitrile rubber with black identification stripe.
- Reinforcement** : High tensile steel wire helix embedded between layers of synthetic yarns.
- Tube** : Black fuel and chemical resistant Viton.
- Temperature** : -32C to +121C(-25F to +250F)

Nom. I.D	Nom. O.D	Vacuum (Hg)	Bend Radius	PSI	Weight (lbs)	Std Pack Qty	Part #
3/4"	1.15"	28"	4.50"	150	0.50	100'	VLS-075
1"	1.40"	28"	5.00"	150	0.60	100'	VLS-100
1-1/2"	2.00"	28"	6.00"	150	0.95	100'	VLS-150
2"	2.60"	28"	7.00"	150	1.48	100'	VLS-200
3"	3.60"	28"	12.00"	150	2.20	100'	VLS-300

Cut Lengths : Plus 10%

Standard Lengths : 100'

Recommended Couplings : Cam and groove

Air and General Purpose Hose

Water Suction and Discharge Hose

Petroleum, Steam and Chemical Hose

Rubber Material Handling Hose

Plastic Material Handling Hose

Food Hose

Ducting

Auto Truck and Marine Hose

Fire Hose

Welding and Other Hose

Cam and Groove

Nipples, Menders and Shank Fittings

Clamps

High Pressure Fittings

Mine Fittings

Air Fittings

Valves

Sandblast

Fire Fittings

Pipe Fittings

Sheet Rubber

Index and Technical Information

Air and General Purpose Hose

Water Suction and Discharge Hose

Petroleum, Steam and Chemical Hose

Rubber Material Handling Hose

Plastic Material Handling Hose

Food Hose

Ducting

Auto Truck and Marine Hose

Fire Hose

Welding and Other Hose

Cam and Groove

Nipples, Menders and Shank Fittings

Clamps

High Pressure Fittings

Mine Fittings

Air Fittings

Valves

Sandblast

Fire Fittings

Pipe Fittings

Sheet Rubber

Index and Technical Information

CHEMICAL



- Application** : The cross-linked polyethylene tube makes this one of the most versatile types of hose available to the chemical industry today. It will handle 90% of common chemical and petroleum products in both suction and discharge applications.
- Cover** : Green smooth chemical resistant EPDM rubber
- Reinforcement** : High tensile wire helix embedded between layers of textile cords.
- Tube** : Smooth chemical resistant (XLPE) cross-linked polyethylene.
- Temperature** : -29C to +120C(-20F to +248F)

	Nom. I.D	Nom. O.D	Vacuum (Hg)	Bend Radius	PSI	Weight (lbs)	Std Pack Qty	Part #
	1/2"	0.97"	29"	7.00"	200	0.34	100'	CHX-050
	3/4"	1.26"	29"	7.00"	200	0.41	100'	CHX-075
	1"	1.50"	29"	8.00"	200	0.51	100'	CHX-100
	1-1/4"	1.77"	29"	9.00"	200	0.64	100'	CHX-125
	1-1/2"	2.05"	29"	11.00"	200	0.92	100'	CHX-150
	2"	2.60"	29"	15.00"	200	1.30	100'	CHX-200
	2-1/2"	3.00"	29"	22.00"	200	1.45	100'	CHX-250
	3"	3.62"	29"	24.00"	200	2.08	100'	CHX-300
	4"	4.64"	29"	30.00"	200	3.04	100'	CHX-400

Cut Lengths : Plus 10%

Standard Lengths : 100'

Safety Information : Reduced pressure ratings are advised when handling hot corrosive chemicals

Recommended Couplings : Cam and groove

FLEXCHEM



Application : The (UHMW) Ultra High Molecular Weight polyethylene tube makes this one of the most versatile types of hose available to the chemical industry today. It will handle 94% of common chemical and petroleum products in both suction and discharge applications. This hose is very flexible due to its corrugated cover and low temperature characteristics.

Cover : Green corrugated chemical resistant EPDM rubber
Reinforcement : High tensile wire helix embedded between layers of textile cords.
Tube : Smooth chemical resistant (UHMW) Ultra High Molecular Weight polyethylene.
Temperature : -40C to +65C (-40F to +150F)

Nom. I.D	Nom. O.D	Vacuum (Hg)	Bend Radius	PSI	Weight (lbs)	Std Pack Qty	Part #
3/4"	1.22"	29"	4.00"	200	0.43	100'	FLX-075
1"	1.46"	29"	4.00"	200	0.46	100'	FLX-100
1-1/4"	1.73"	29"	5.00"	200	0.75	100'	FLX-125
1-1/2"	1.97"	29"	5.00"	200	0.85	100'	FLX-150
2"	2.44"	29"	6.00"	200	0.93	100'	FLX-200
3"	3.58"	29"	9.00"	200	1.94	100'	FLX-300
4"	4.64"	29"	12.00"	150	3.17	100'	FLX-400

Cut Lengths : Plus 10%

Standard Lengths : 100'

Safety Information : Reduced pressure ratings are advised when handling hot corrosive chemicals

Recommended Couplings : Cam and groove

Air and General Purpose Hose

Water Suction and Discharge Hose

Petroleum, Steam and Chemical Hose

Rubber Material Handling Hose

Plastic Material Handling Hose

Food Hose

Ducting

Auto Truck and Marine Hose

Fire Hose

Welding and Other Hose

Cam and Groove

Nipples Menders and Shank Fittings

Clamps

High Pressure Fittings

Mine Fittings

Air Fittings

Valves

Sandblast

Fire Fittings

Pipe Fittings

Sheet Rubber

Index and Technical Information

CHEMICAL RESISTANCE GUIDE

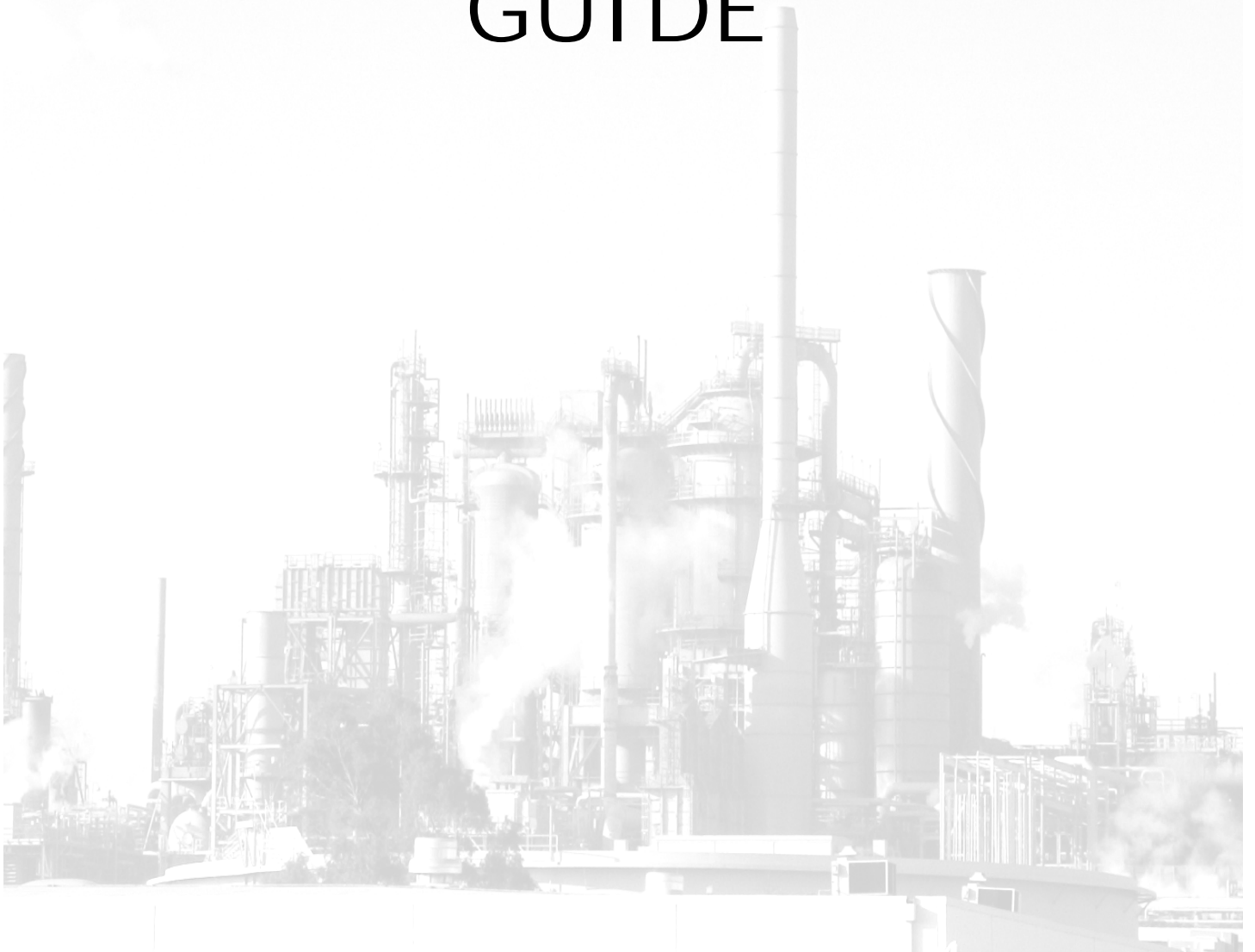

BUCHANAN RUBBER CHEMICAL RESISTANCE GUIDE

Chemical	HOSE TEMPERATURE (F)	PVC TEMPERATURE (F)	HOSE AND SHEET RUBBER									THERMOPLASTIC HOSE			COUPLINGS				GASKETS						
			UHMWPE	SBR	BUTYL	HYPALON	NATURAL	VITON	NITRILE	EPDM	XLPE	TPU	PVC	TPR	304SS	316SS	ALUMINUM	BRASS	NYLON	POLYPROPYLENE	TEFLON	SILICONE	VITON	BUNA	EPDM
			RATING DEFINITION A = CONTINUOUS SERVICE B = FOR INTERMITTENT USE I = INSUFFICIENT DATA X = DO NOT USE																						
Acetaldehyde	100	70	B	X	B	X	X	X	X	A	A	X	X	X	A	A	B	X	A	A	T	S			E
Acetic Acid, Conc.	100	70	A	I	A	X	B	X	X	A	A	X	B	I	I	A	B	X	I	I	T				E
Acetic Acid, Dilute 10	150	70	B	I	A	X	A	X	X	A	A	B	A	I	I	A	I	X	I	I	T		V		E
Acetic Acid, Glacial	100	70	A	X	B	X	X	X	X	A	A	X	B	X	A	A	B	X	X	A	T	S			E
Acetic Aldehyde	100	70	A	I	B	X	X	X	X	A	A	I	X	X	I	A	B	X	I	I	T				E
Acetic Anhydride	100	70	B	X	A	B	X	X	X	A	A	X	X	X	A	A	B	X	X	A	T	S			E
Acetic Ester	100	70	B	I	B	X	X	X	X	A	A	X	X	B	I	A	A	A	I	I	T		V		E
Acetic Ether	100	70	B	I	B	X	X	X	X	A	A	X	X	I	I	A	A	A	I	I	T				E
Acetic Oxide	100	70	B	I	A	B	X	X	X	A	A	I	I	I	I	A	B	X	I	I	T				E
Acetone	100	70	A	A	A	X	B	X	X	A	A	X	X	B	A	A	A	I	A	A	T				E
Acetone Cyanohydrin	100	70	B	I	A	X	X	X	X	A	A	X	X	I	I	I	I	I	I	I	T	S			E
Acetyl Acetone	100	70	B	X	B	X	X	X	X	I	A	X	X	I	I	I	B	I	I	I	T				E
Acetyl Chloride	100	70	B	X	X	X	X	X	B	B	B	X	I	X	B	B	X	A	I	I	T		V		E
Acetyl Oxide	100	70	B	I	A	B	X	X	X	A	A	I	I	I	I	A	B	X	I	I	T				E
Acetylene (dry)	100	70	A	I	A	A	A	A	A	A	A	I	I	I	I	A	I	I	I	I	T	S	V	B	E
Acetylene Dichloride	100	70	B	I	X	X	X	A	X	I	A	I	X	X	I	I	A	X	I	I	T		V		E
Acetylene Tetrachloride	100	70	B	I	X	X	X	A	X	I	A	I	X	I	I	A	X	X	I	I	T		V		E
Acrolein	100	70	B	I	A	B	B	A	B	I	A	I	I	I	I	I	I	I	I	I	T		V		E
Acrylic Acid	100	70	B	I	X	X	X	A	X	X	A	I	I	I	I	A	I	I	I	I	T		V		E
Acrylonitrile	100	70	B	X	X	X	X	X	X	B	A	A	I	A	A	X	I	I	A	T					E
Alk-Tri	100	70	I	I	X	X	X	A	X	I	A	I	I	I	I	A	I	I	I	I	T		V		E
Allyl Alcohol	100	70	A	A	A	A	A	B	A	A	A	X	X	X	I	A	I	A	I	I	T			B	E
Allyl Bromide	100	70	B	X	X	X	X	B	X	I	B	X	X	I	I	I	I	I	I	I	T				E
Allyl Chloride	100	70	B	X	X	X	X	B	X	X	B	X	X	I	I	A	X	X	I	I	T	S			E
Alum	150	70	A	I	A	A	A	A	A	A	A	A	A	B	I	A	I	X	I	I	T	S	V	B	E
Aluminum Acetate	100	70	A	B	A	A	X	X	X	A	A	I	I	I	I	A	I	X	I	I	T				E
Aluminum Chloride	150	70	A	A	A	A	A	A	A	A	A	A	B	X	I	I	X	X	A	T		V	B	E	
Aluminum Formate	100	70	A	I	B	X	X	X	X	I	A	I	I	I	I	I	I	I	I	I	T				E
Aluminum Hydroxide	150	70	A	A	A	B	A	X	B	A	A	A	A	I	A	A	I	X	A	A	T	S			E
Aluminum Sulfate	150	70	A	A	A	A	A	A	A	A	A	A	B	B	A	X	X	A	A	T	S	V	B	E	
Aminoethanol	100	70	A	I	A	B	B	I	B	I	A	I	I	I	I	A	B	I	I	I	T			B	E
Aminoethylethanolamine	100	70	A	I	A	B	B	I	B	I	A	I	I	I	I	I	I	I	I	I	T				E
Ammonia Cupric Sulfate	150	70	A	I	A	A	X	A	A	A	A	I	X	I	I	I	I	I	I	I	T		V	B	E
Ammonium Chloride	150	70	A	A	A	A	A	A	A	A	A	A	B	A	A	X	X	A	A	T		V	B	E	
Ammonium Hydroxide	150	70	A	A	A	B	A	X	X	X	A	B	B	B	A	A	X	I	A	A	T	S			E
Ammonium Nitrate (ANFO)			N/R																						▶
Ammonium Phosphate	150	70	A	A	A	A	A	A	A	A	A	I	I	B	I	A	X	X	A	A	T	S	V	B	E
Ammonium Sulfate	150	70	A	A	A	A	A	A	X	A	A	A	A	B	X	A	X	X	A	A	T	S	V		E
Ammonium Sulfide	150	70	A	A	A	A	A	A	X	A	A	A	A	I	I	A	X	X	I	I	T		V		E
Ammonium Sulfite	150	70	A	A	A	A	A	A	A	A	A	A	A	I	I	A	X	I	I	I	T		V	B	E
Ammonium Thiosulfate	100	70	A	A	A	A	A	A	A	A	A	A	A	I	I	A	B	X	I	I	T		V	B	E
Amyl Acetate	100	70	A	X	A	B	X	X	X	B	A	X	X	X	I	A	A	I	I	I	T				E
Amyl Alcohol	100	70	A	A	A	A	A	B	A	A	A	B	B	X	A	A	I	A	A	A	T	S		B	E
Amyl Alcohol	100	70	A	A	A	A	A	B	A	A	A	B	B	X	A	A	I	A	A	A	T	S		B	E

BUCHANAN RUBBER CHEMICAL RESISTANCE GUIDE

Chemical	HOSE TEMPERATURE (F)	PVC TEMPERATURE (F)	HOSE AND SHEET RUBBER									THERMOPLASTIC HOSE			COUPLINGS					GASKETS					
			UHMWPE	SBR	BUTYL	HYPALON	NATURAL	VITON	NITRILE	EPDM	XLPE	TPU	PVC	TPR	304SS	316SS	ALUMINUM	BRASS	NYLON	POLYPROPYLENE	TEFLON	SILICONE	VITON	BUNA	EPDM
Amyl Chloride	100	70	A	X	X	X	X	A	X	X	A	X	X	B	A	X	I	B	X	T		V			
Amyl Oleate	100	70	A	X	X	X	X	I	B	I	A	I	I	I	I	I	I	I	I	T					
Amyl Phenol	100	70	A	X	X	X	X	A	X	I	A	I	X	I	I	I	I	I	I	T		V			
Amyl Phthalate	100	70	A	I	A	X	X	X	X	I	A	I	X	I	I	I	I	I	I	T					
Amylamine	100	70	A	A	B	X	X	X	X	X	A	I	I	I	I	I	I	I	I	T					
Anethole	100	70	X	X	X	X	X	B	X	I	X	I	I	I	I	I	I	I	I	T					
Anhydrous Ammonia			N/R												B	A	A	X	A	X	T		B		
Aniline	100	70	A	X	A	X	X	A	X	A	A	I	I	I	A	A	B	X	X	T		V		E	
Animal Grease	100	70	A	X	X	X	X	A	A	X	A	A	A	I	I	A	A	I	I	T		V	B		
Animal Oils	100	70	A	X	B	X	X	A	A	X	A	A	A	X	I	A	A	I	I	T		V	B		
Antimony Pentachloride	100	70	A	X	X	X	X	I	X	X	B	I	I	I	I	I	I	I	I	T					
Aqua Ammonia	150	70	A	I	A	B	A	A	B	B	A	I	B	I	I	A	X	I	I	T		V			
Aromatic Spirits	100	70	A	I	X	X	X	A	X	X	A	I	I	I	I	A	I	I	I	T		V			
Aromatic Tar	100	70	A	I	X	X	X	A	X	X	A	X	X	I	I	I	I	I	I	T		V			
Arquads	100	70	A	I	A	A	A	A	A	A	A	I	I	I	I	I	I	I	I	T		V	B	E	
Arsenic Acid	100	70	A	A	A	A	A	I	X	A	A	A	A	I	A	A	X	X	X	A	T	S	V	E	
Arsenic Chloride	100	70	I	X	X	X	X	X	X	X	X	A	A	I	I	I	I	I	I	T					
Arsenic Trichloride	100	70	I	X	X	X	X	X	X	X	X	A	A	I	I	X	I	I	I	T					
Asphalt	500	70	CALL																	T		V			
ASTM #1 Oil	100	70	A	X	X	B	X	A	A	X	A	A	A	X	I	A	A	I	I	T	S	V	B		
ASTM #2 Oil	100	70	A	X	X	X	X	A	A	X	A	A	A	X	I	A	A	A	I	T		V	B		
ASTM #3 Oil	100	70	A	X	X	X	X	A	A	X	A	A	A	X	I	A	A	A	I	T		V	B		
Barium Carbonate	150	70	A	A	A	A	A	A	A	A	A	A	A	I	A	A	X	I	A	A	T	V	B	E	
Barium Chloride	150	70	A	A	A	A	A	A	A	A	A	A	A	I	X	A	X	I	A	A	T	V	B	E	
Barium Hydroxide	150	70	A	A	A	A	A	B	A	A	A	A	A	I	B	A	X	X	A	A	T	S	V	E	
Barium Sulfate	150	70	A	A	A	A	A	A	A	A	A	A	A	I	A	B	A	X	A	A	T	S	V	E	
Barium Sulfide	150	70	A	A	A	A	A	A	A	A	A	A	A	I	I	A	X	X	A	A	T	S	V	E	
Benzal Chloride	100	70	A	I	B	I	I	I	X	I	A	I	I	I	B	X	I	I	I	T					
Benzaldehyde	100	70	A	X	B	X	X	X	X	B	A	X	X	X	A	A	B	I	X	X	T				
Benzene (Benzol)	100	70	A	X	X	X	X	A	X	X	A	X	X	X	I	A	A	A	I	T		V			
Benzene (Ligroin)	100	70	A	I	X	X	X	A	A	X	A	X	X	X	I	A	A	I	I	T		V	B		
Benzene Solvent (Ligroin)	100	70	A	X	X	X	X	A	A	X	A	X	X	X	I	A	A	I	I	T	S	V	B		
Benzoic Acid	100	70	A	X	B	B	X	I	I	B	A	B	A	B	A	B	X	X	X	T		V			
Benzoic Aldehyde	100	70	A	X	B	X	X	X	X	B	A	I	X	I	I	A	I	B	I	T					
Benzotrichloride	100	70	X	X	I	I	I	I	X	X	X	I	X	I	I	I	I	I	I	T					
Benzoyl Chloride	100	70	X	X	I	I	I	I	X	X	B	I	X	I	I	B	I	I	I	T					
Benzyl Acetate	100	70	A	X	A	B	X	X	X	I	A	I	X	I	I	B	I	I	I	T					
Benzyl Alcohol	100	70	A	A	A	X	X	A	X	X	A	I	I	I	A	A	B	I	A	A	T	S	V		
Benzyl Chloride	100	70	A	X	X	X	X	A	X	X	A	I	X	I	I	A	X	X	I	T		V			
Benzyl Chloride	100	70	A	X	X	X	X	A	X	X	A	I	X	I	I	A	X	X	I	T		V			
Bichromate of Soda	150	70	A	X	A	X	I	I	I	I	A	I	A	I	I	I	I	I	I	T					
Black Sulfate Liquor	150	70	A	A	X	B	B	B	B	B	A	A	A	I	I	A	X	X	I	T		V	B		
Black Sulfate Liquor	275	70	X	A	X	X	X	X	X	X	X	A	A	I	I	A	X	X	I	T					
Bleach	100	70	X	I	B	X	X	B	X	A	X	A	A	B	I	X	X	X	X	A	T	V		E	

BUCHANAN RUBBER CHEMICAL RESISTANCE GUIDE

Chemical	HOSE TEMPERATURE (F)	PVC TEMPERATURE (F)	HOSE AND SHEET RUBBER									THERMOPLASTIC HOSE			COUPLINGS					GASKETS					
			UHMWPE	SBR	BUTYL	HYPALON	NATURAL	VITON	NITRILE	EPDM	XLPE	TPU	PVC	TPR	304SS	316SS	ALUMINUM	BRASS	NYLON	POLYPROPYLENE	TEFLON	SILICONE	VITON	BUNA	EPDM
Brine	150	70	A	A	A	A	A	A	A	A	A	A	B	I	A	X	I	X	A	T	S	V	B	E	
Bromine	100	70	X	X	X	X	X	B	X	X	X	X	X	I	X	X	X	X	X	T		V			
Bromo Benzene	100	70	B	I	X	X	X	B	X	X	X	I	X	X	I	I	I	I	T		V				
Bromo Toluene	100	70	X	I	X	X	X	B	X	X	X	I	X	I	I	I	I	I	T						
Bromochloromethane	100	70	X	I	B	X	X	B	X	I	X	I	X	X	I	A	X	X	I	T					
Bunker C.	100	70	B	I	X	X	X	A	A	X	A	I	I	I	I	A	I	I	I	T		V	B		
Bunker Oil	100	70	B	X	X	X	X	A	A	X	X	I	I	I	I	A	I	I	I	T		V	B		
Butanol	100	70	A	I	A	A	A	B	A	A	A	I	X	B	A	A	I	I	I	T			B		
Butyl (Normal) Alcohol	100	70	A	I	A	A	A	B	A	A	A	I	X	B	I	A	I	I	I	T			B		
Butyl (Secondary) Alcohol	100	70	A	I	A	A	A	B	A	A	A	I	X	B	I	A	I	I	I	T			B		
Butyl Acetate	100	70	A	X	A	B	X	X	X	B	A	X	X	X	I	A	B	I	I	T					
Butyl Acetoacetate	100	70	A	I	X	X	X	X	X	I	A	I	X	I	I	I	I	I	I	T					
Butyl Acrylate	100	70	B	X	X	X	X	X	X	X	B	I	X	I	I	I	I	I	I	T					
Butyl Alcohol	100	70	A	I	A	A	A	B	A	A	A	A	B	A	A	I	I	A	A	T			B		
Butyl Aldehyde	100	70	A	I	B	X	X	X	X	X	A	I	I	I	I	X	A	X	I	T					
Butyl Amine	100	70	A	I	B	X	X	X	X	X	A	I	I	I	I	A	A	I	I	T					
Butyl Benzene	100	70	A	X	X	X	X	A	X	X	A	I	X	I	I	I	I	I	I	T		V			
Butyl Benzl Phthalate	100	70	A	I	A	X	X	X	X	I	A	I	X	I	I	I	I	I	I	T					
Butyl Bromide	100	70	B	X	X	X	X	B	X	X	B	I	X	I	I	I	I	I	I	T					
Butyl Butyrate	100	70	B	X	X	X	X	X	X	I	B	I	X	I	I	I	I	I	I	T		V			
Butyl Carbitol	100	70	A	X	A	A	X	I	X	B	A	I	I	I	I	I	I	I	I	T					
Butyl Cellosolve	100	70	A	X	A	A	X	X	X	A	X	I	I	I	I	A	A	X	I	T			E		
Butyl Chloride	100	70	B	X	X	X	X	A	X	I	B	I	X	I	I	B	I	I	I	T		V			
Butyl Ether	100	70	A	X	X	B	X	X	B	X	A	I	I	I	I	A	I	I	I	T					
Butyl Ethyl Acetaldehyde	100	70	A	X	B	X	X	X	X	I	A	I	I	I	I	I	I	I	I	T					
Butyl Ethyl Ether	100	70	A	X	X	B	X	I	B	X	A	I	I	I	I	I	I	I	I	T					
Butyl Phthalate	100	70	A	X	A	X	X	X	X	I	A	I	X	X	I	A	A	I	I	T					
Butyl Stearate	100	70	A	X	X	X	X	I	A	X	A	I	I	I	I	A	A	A	I	T	S		B		
Butylate	100	70	A	I	I	I	I	I	I	A	I	I	I	I	I	I	I	I	I	T			E		
Butyraldehyde	100	70	A	X	B	X	X	X	X	X	A	I	I	I	I	X	A	X	I	T					
Butyric Acid	100	70	A	X	X	B	X	I	X	B	A	I	X	I	A	A	B	I	X	T					
Butyric Anhydride	100	70	A	X	X	B	X	I	X	I	A	I	I	I	I	I	I	I	I	T					
Cadmium Acetate	100	70	A	I	A	A	X	X	X	I	A	I	A	I	I	I	I	I	I	T					
Calcium Acetate	100	70	A	X	A	A	X	X	X	A	A	I	A	I	I	A	I	I	I	T			B		
Calcium Aluminate	100	70	A	I	A	A	A	A	A	A	A	I	A	I	I	I	I	I	I	T		V	B		
Calcium Bichromate	150	70	X	I	A	X	I	I	I	I	X	I	A	I	I	I	I	I	I	T					
Calcium Bisulfate	150	70	A	A	A	A	A	A	A	A	A	I	A	I	X	A	X	X	X	T		V	B		
Calcium Bisulfite	150	70	A	A	A	A	A	A	A	A	I	A	A	I	A	A	X	X	X	T	S	V	B		
Calcium Carbonate	150	70	A	A	A	A	A	A	A	A	A	A	A	I	A	A	I	X	A	T	S	V	B		
Calcium Chloride	150	70	A	A	A	A	A	A	A	A	A	A	A	I	A	B	X	X	A	T	S	V	B		
Calcium Hydroxide (Caustic Lime)	100	70	A	I	A	B	A	X	B	A	A	A	A	I	I	A	X	X	A	T	S				
Calcium Hypochlorite	100	70	B	X	B	X	X	B	X	B	X	A	A	I	X	A	X	X	X	T		V			
Calcium Nitrate	150	70	A	A	A	A	A	A	A	A	A	A	A	I	I	B	X	X	I	T		V	B		
Calcium Silicate	150	70	A	I	A	A	A	A	A	A	A	A	A	I	I	I	A	I	I	T		V	B		

BUCHANAN RUBBER CHEMICAL RESISTANCE GUIDE

Chemical	HOSE TEMPERATURE (F)	PVC TEMPERATURE (F)	HOSE AND SHEET RUBBER									THERMOPLASTIC HOSE			COUPLINGS					GASKETS					
			UHMWPE	SBR	BUTYL	HYPALON	NATURAL	VITON	NITRILE	EPDM	XLPE	TPU	PVC	TPR	304SS	316SS	ALUMINUM	BRASS	NYLON	POLYPROPYLENE	TEFLON	SILICONE	VITON	BUNA	EPDM
Calcium Sulfate	150	70	A	A	A	A	A	A	A	A	A	A	I	A	A	I	I	A	A	T	S	V	B	E	
Calcium Sulphhydrate	100	70	A	I	A	A	A	A	A	A	A	I	I	I	I	I	I	I	I	T		V	B	E	
Calcium Sulfide	150	70	A	A	A	A	A	A	A	A	A	A	I	I	A	X	X	I	I	T		V	B	E	
Calcium Sulfite	150	70	A	A	A	A	X	A	A	A	A	A	I	I	B	B	X	I	I	T	S	V	B	E	
Caprylic Acid	100	70	A	I	X	B	X	I	X	I	A	I	I	I	B	I	X	I	I	T					
Carbitol	100	70	A	X	A	A	X	I	X	A	A	I	I	I	B	A	X	I	I	T				E	
Carbitol Acetate	100	70	A	X	B	B	X	I	X	I	A	I	I	I	I	I	I	I	I	T					
Carbolic Acid, Phenol	100	70	A	I	A	X	X	A	X	X	A	X	X	X	I	A	B	A	I	I	T		V		
Carbon Dioxide	100	70	A	A	A	A	A	A	A	A	A	A	A	B	I	A	B	I	I	I	T	S	V	B	E
Carbon Disulfide			N/R												B	B	A	X	A	X	T		V		
Carbon Tetrachloride	100	70	B	X	X	X	X	A	X	X	A	X	X	X	A	A	I	I	A	X	T		V		
Carbonic Acid	100	70	A	A	A	A	A	A	A	A	A	I	A	I	A	B	B	X	A	T	S	V	B	E	
Casinghead Gasoline	100	70	B	I	X	X	X	A	A	X	B	I	X	X	I	I	I	I	I	I	T		V	B	
Caster Oil (Castor Oil)	100	70	A	I	A	A	X	A	A	A	A	I	I	I	A	A	I	X	A	T	S	V	B	E	
Caustic Potash	150	70	A	A	A	B	A	X	B	B	A	A	A	I	A	X	X	A	A	T					
Caustic Soda	150	70	A	I	A	B	A	X	B	A	A	A	A	B	I	A	X	X	X	A	T	S		E	
Cellosize	100	70	A	I	A	X	X	I	X	I	A	I	I	I	I	I	I	I	I	I	T				
Cellosolve	100	70	A	X	A	A	X	X	X	A	A	I	I	I	A	A	X	X	I	T				E	
Cellosolve Acetate	100	70	A	I	B	B	X	X	X	B	A	I	I	I	A	I	X	I	I	T					
Chloracetic Acid	100	70	A	I	X	X	B	X	X	X	A	I	I	I	X	A	X	X	X	T					
Chlorinated Solvents	100	70	B	I	X	X	X	A	X	X	A	I	X	I	I	B	X	A	I	I	T		V		
Chlorine (Dry) (Gas)			N/R																						
Chlorine (Wet)	100	70	B	I	X	X	X	B	X	X	X	B	X	B	I	X	X	X	I	I	T		V		
Chloroacetone	100	70	A	X	I	X	X	X	X	X	A	I	X	I	I	A	X	X	I	I	T				
Chlorobenzene	100	70	B	X	X	X	X	A	X	X	A	X	X	I	A	B	I	I	I	T		V			
Chlorobenzol	100	70	A	I	X	X	X	A	X	X	A	I	I	I	A	B	I	I	I	T		V			
Chlorobutane	100	70	X	X	X	X	X	A	X	I	X	I	X	I	I	I	I	I	I	T		V			
Chloroethylbenzene	100	70	A	I	X	X	X	A	X	X	A	I	X	I	I	I	I	I	I	T		V			
Chloroform	100	70	B	X	X	X	X	B	X	X	X	X	X	X	A	A	B	I	X	T		V			
Chloropentane	100	70	A	X	X	X	X	A	X	X	A	I	X	X	I	A	X	I	I	T		V			
Chlorophenol	100	70	A	X	X	X	X	B	X	X	X	I	X	I	I	I	I	I	I	T		V			
Chloropropanone	100	70	A	X	I	X	X	X	X	X	A	I	X	I	I	I	I	I	I	T					
Chlorosulfonic Acid	100	70	X	X	X	X	X	X	X	X	X	I	B	X	X	B	X	X	X	T					
Chlorothene	100	70	X	I	X	X	X	A	X	X	A	I	X	X	I	A	I	I	I	T		V			
Chlorotoluene	100	70	X	X	X	X	X	A	X	X	X	X	X	X	I	A	I	I	I	T		V			
Chlorpyrifos	100	70	I	I	I	I	I	I	X	I	I	I	I	I	I	I	I	I	I						
Chromic Acid 25%	100	70	B	I	X	B	X	I	X	X	X	I	I	I	I	B	X	X	X	T		V			
Coal Oil	100	70	A	X	X	X	X	A	A	X	A	I	I	I	I	A	X	A	I	T		V	B		
Coal Tar	100	70	A	X	X	X	X	A	X	X	A	I	I	I	I	A	I	I	I	T	S	V			
Coal Tar Naptha	100	70	A	X	X	X	X	A	X	X	A	I	I	I	I	A	I	I	I	T		V			
Copper Chloride	100	70	A	A	A	A	X	A	A	A	A	A	A	B	X	X	X	A	A	T	S	V	B	E	
Copper Hydrate	100	70	A	I	A	B	X	X	B	I	A	I	A	I	I	I	I	I	I	T			B		
Copper Hydroxide	100	70	A	I	A	B	X	X	B	I	A	I	A	I	I	I	I	I	I	T			B		
Copper Nitrate	100	70	A	A	A	A	X	A	A	A	A	A	A	I	A	A	X	X	X	A	T	S	V	B	E

BUCHANAN RUBBER CHEMICAL RESISTANCE GUIDE

Chemical	HOSE TEMPERATURE (F)	PVC TEMPERATURE (F)	HOSE AND SHEET RUBBER									THERMOPLASTIC HOSE			COUPLINGS					GASKETS					
			UHMWPE	SBR	BUTYL	HYPALON	NATURAL	VITON	NITRILE	EPDM	XLPE	TPU	PVC	TPR	304SS	316SS	ALUMINUM	BRASS	NYLON	POLYPROPYLENE	TEFLON	SILICONE	VITON	BUNA	EPDM
			RATING DEFINITION A = CONTINUOUS SERVICE B = FOR INTERMITTENT USE I = INSUFFICIENT DATA X = DO NOT USE																						
Copper Nitrite	100	70	A	A	A	A	X	A	A	A	A	A	I	I	I	I	I	I	I	T		V	B	E	
Copper Sulfate	100	70	A	A	A	A	X	A	A	A	A	A	I	A	A	X	X	A	A	T	S	V	B	E	
Copper Sulfide	100	70	A	A	A	A	X	A	A	A	A	B	A	I	I	I	I	I	I	T		V	B	E	
Creosols	100	70	A	I	A	X	X	A	X	X	A	I	I	I	A	I	X	I	I	T		V			
Creosote	100	70	A	I	X	X	X	A	B	X	A	X	X	X	A	A	I	I	I	X	T		V		
Cresylic Acid	100	70	A	X	A	X	X	I	X	X	A	I	I	I	A	A	B	X	X	I	T		V		
Crotonaldehyde	100	70	A	X	A	X	X	X	X	I	A	I	I	I	I	I	I	I	I	T		V			
Crude Oil	100	70	A	X	X	X	X	X	A	X	A	B	A	X	I	A	A	I	I	I	T		V	B	
Cumene	100	70	A	X	X	X	X	A	X	X	A	I	I	I	I	I	I	I	I	T		V			
Cupric Carbonate	100	70	A	B	A	A	X	A	A	A	A	I	A	I	I	I	I	I	I	T		V	B	E	
Cupric Chloride	100	70	A	B	A	A	X	A	A	A	A	A	I	I	I	B	X	I	I	T	S	V	B	E	
Cupric Nitrate	100	70	A	B	A	A	X	A	A	A	A	A	I	I	I	B	I	I	I	T		V	B	E	
Cupric Nitrite	100	70	A	B	A	A	X	A	A	A	A	A	I	I	I	I	I	I	I	T		V	B	E	
Cupric Sulfate	100	70	A	A	A	A	X	A	A	A	A	A	I	I	I	I	I	I	I	T	S	V	B	E	
Cyclohexane	100	70	A	X	X	X	X	A	B	X	A	X	X	A	A	B	X	I	X	T		V			
Cyclohexanol	100	70	A	X	X	X	X	B	B	X	A	X	X	X	I	A	X	X	I	I	T		V	B	
Cyclohexanone	100	70	A	X	X	X	X	X	X	X	A	X	X	X	I	A	I	I	I	T		V			
Cyclopentane	100	70	A	X	X	X	X	A	B	X	A	I	I	I	I	I	I	I	I	T		V			
Cyclopentane, methyl	100	70	A	I	X	X	X	A	B	X	A	I	A	I	I	I	I	I	I	T		V			
Cyclopentanol	100	70	A	I	X	X	X	B	B	X	A	I	A	I	I	I	I	I	I	T		V	B		
Cyclopentanone	100	70	A	I	X	X	X	X	X	X	A	I	A	I	I	I	I	I	I	T		V			
D.D.T. in Kerosene	100	70	A	I	X	X	X	A	A	X	A	X	X	I	I	A	I	A	I	T		V	B		
D.M.P.	100	70	X	I	X	X	X	X	X	X	X	I	I	I	I	A	I	I	I	T		V			
Decalin®	100	70	X	I	X	X	X	A	X	X	A	I	I	I	I	I	I	I	I	T		V			
Decanol	100	70	A	I	A	A	X	B	A	A	A	I	B	I	I	I	I	I	I	T			B	E	
Decyl Alcohol	100	70	A	I	A	A	X	B	A	A	A	I	A	I	I	I	I	I	I	T			B	E	
Decyl Aldehyde	100	70	A	I	X	X	X	X	X	I	A	I	I	I	I	I	I	I	I	T					
Decyl Butyl Phthalate	100	70	A	I	A	X	X	X	X	I	A	X	X	X	I	I	I	I	I	T					
Denatured Alcohol	100	70	A	I	A	A	A	B	A	A	A	I	A	I	A	B	A	I	I	T			B	E	
Diacetone Alcohol	100	70	A	X	A	B	B	X	X	X	A	B	A	B	A	A	I	I	A	X	T				
Diamyl Phenol	100	70	A	I	X	X	X	A	X	X	A	X	X	X	I	I	I	I	I	T		V			
Diamylamine	100	70	A	B	A	X	B	I	B	I	A	I	I	I	I	I	I	I	I	T			B		
Diamylene	100	70	A	I	X	X	X	A	X	X	A	I	I	I	I	I	I	I	I	T		V			
Dibenzyl Ether	100	70	A	X	B	X	X	I	X	X	A	I	I	I	I	A	A	X	I	T					
Dibromobenzene	100	70	B	X	X	X	X	A	X	X	A	I	X	I	I	I	I	I	I	T		V			
Dibutyl Amine	100	70	A	I	X	X	B	X	B	X	A	I	X	I	I	I	I	I	I	T					
Dibutyl Ether	100	70	A	I	X	B	X	X	X	X	A	I	I	I	I	A	A	X	I	T					
Dibutyl Phthalate	100	70	A	I	A	X	X	X	X	A	A	X	X	X	I	A	A	I	I	T		V		E	
Dibutyl Sebacate	100	70	A	X	A	X	X	X	X	X	A	I	X	I	I	I	I	I	I	T	S	V			
Dicalcium Phosphate	100	70	A	A	A	A	A	A	A	A	A	B	A	I	I	I	I	I	I	T		V	B	E	
Dicamba	100	70	A	I	I	I	I	I	I	A	A	I	I	I	I	I	I	I	I	T				E	
Dichloroacetic Acid	100	70	A	X	X	X	B	X	X	I	A	I	I	I	I	I	I	I	I	T					
Dichlorobenzene	100	70	A	I	X	X	X	A	X	X	A	X	X	X	I	A	B	I	I	T		V			
Dichlorobutane	100	70	A	X	X	X	X	A	X	X	A	I	X	I	I	I	I	I	I	T		V			

BUCHANAN RUBBER CHEMICAL RESISTANCE GUIDE

Chemical	HOSE TEMPERATURE (F)	PVC TEMPERATURE (F)	HOSE AND SHEET RUBBER									THERMOPLASTIC HOSE			COUPLINGS					GASKETS					
			UHMWPE	SBR	BUTYL	HYPALON	NATURAL	VITON	NITRILE	EPDM	XLPE	TPU	PVC	TPR	304SS	316SS	ALUMINUM	BRASS	NYLON	POLYPROPYLENE	TEFLON	SILICONE	VITON	BUNA	EPDM
Dichlorodifluoromethane	100	70	I	X	X	X	X	B	B	X	I	I	I	I	I	I	I	I	I	T		V	B		
Dichloroethane	100	70	A	X	X	X	X	A	X	X	A	I	X	I	I	I	I	I	I	T		V			
Dichloroethyl Ether	100	70	A	X	X	X	X	I	X	X	A	I	X	X	I	I	I	I	I	T					
Dichloroethylene	100	70	X	X	X	X	X	A	X	I	X	I	X	X	I	I	A	X	I	I	T		V		
Dichlorohexane	100	70	A	X	X	X	X	A	X	X	A	I	X	X	I	I	I	I	I	T		V			
Dichloromethane	100	70	A	X	X	X	X	A	X	X	A	I	X	X	I	A	B	I	I	I	T		V		
Dichloropentane	100	70	A	X	X	X	X	A	X	X	A	I	X	X	I	I	I	I	I	T		V			
Dichloropropane	100	70	A	I	X	X	X	A	X	X	B	I	X	X	I	A	X	I	I	I	T		V		
Diesel Oil	150	70	A	X	X	X	X	A	A	X	A	I	B	X	I	A	A	I	I	I	T		V	B	
Diethanol Amine	100	70	A	I	A	X	B	I	B	I	A	I	I	I	I	A	I	I	I	T					
Diethyl Benzene	100	70	A	X	X	X	X	A	X	X	A	I	X	X	I	I	I	I	I	T		V			
Diethyl Carbinol	100	70	A	I	A	A	A	B	A	I	A	I	I	I	I	I	I	I	I	T			B		
Diethyl Ketone	100	70	A	I	B	X	X	X	X	X	A	I	X	I	I	I	I	I	I	T					
Diethyl Oxalate	100	70	A	I	B	X	B	I	X	X	A	I	X	I	I	I	I	I	I	T					
Diethyl Phthalate	100	70	A	X	A	X	X	X	X	X	A	I	X	I	I	I	I	I	I	T					
Diethyl Sebacate	100	70	A	X	A	X	X	X	X	X	A	I	X	I	I	A	A	I	I	T					
Diethyl Sulfate	100	70	A	X	B	X	X	X	X	I	A	I	I	I	I	X	I	I	I	T	S				
Diethyl Triamine	100	70	A	B	A	X	B	I	B	I	A	I	I	I	I	I	I	I	I	T			B		
Diethylamine	100	70	A	B	A	X	B	I	B	B	A	I	I	I	I	A	A	I	X	X	A	T		B	
Diethylene Dioxide	100	70	A	X	B	X	X	X	X	A	A	I	I	I	I	X	X	X	I	I	T			E	
Diethylene Glycol	100	70	A	A	A	A	A	A	A	A	A	I	B	I	I	A	B	A	I	I	T		V	B	E
Diethylene Triamine	100	70	A	I	A	X	B	I	B	I	A	I	I	I	I	I	X	I	I	T					
Dihydroxydiethyl Ether	100	70	A	I	A	A	A	A	A	A	A	I	I	I	I	I	I	I	I	T		V	B	E	
Dihydroxyethyl Amine	100	70	A	B	A	X	B	I	B	I	A	I	I	I	I	I	I	I	I	T			B		
Diisobutyl Ketone	100	70	A	X	B	X	X	X	X	B	A	I	X	I	I	I	I	I	I	T					
Diisobutylene	100	70	A	X	X	X	X	A	X	A	A	I	I	I	I	A	I	I	I	T		V	B		
Diisooctyl Adipate	100	70	A	I	A	X	X	X	X	I	A	I	X	I	I	I	I	I	I	T					
Diisodecyl Phthalate	100	70	A	X	A	X	X	X	X	I	A	I	I	I	I	I	I	I	I	T					
Diisopropanol Amine	100	70	A	B	A	X	B	I	B	I	A	I	I	I	I	I	I	I	I	T			B		
Diisopropyl Amine	100	70	A	I	A	X	B	I	B	I	A	I	X	I	I	I	I	I	I	T			B		
Diisopropyl Ether	100	70	A	X	X	B	X	I	B	X	A	I	I	I	I	A	I	I	I	T			B		
Diisopropyl Ketone	100	70	A	X	B	X	X	X	X	B	A	I	X	I	I	A	A	I	I	T					
Dilauryl Ether	100	70	A	X	I	B	X	I	B	I	A	I	I	I	I	I	I	I	I	T			B		
Dimethyl Amine			N/R																					→	
Dimethyl Benzene	100	70	A	X	X	X	X	A	X	X	A	I	X	I	I	A	I	I	I	T		V			
Dimethyl Carbinol	100	70	A	I	A	A	A	B	A	A	A	I	I	I	I	A	I	I	I	T	S		B	E	
Dimethyl Ether	100	70	A	I	X	B	X	I	B	X	B	I	I	I	I	I	I	I	I	T			B		
Dimethyl Ketone	100	70	A	I	A	X	B	X	X	A	B	I	X	I	I	A	A	I	I	T				E	
Dimethyl Phenol	100	70	A	I	X	X	X	A	X	X	A	I	I	I	I	I	I	I	I	T		V			
Dimethyl Phthalate	100	70	A	X	A	X	X	X	X	B	A	I	X	I	I	A	I	I	I	T		V			
Dimethyl Sulfate	100	70	A	X	B	X	X	X	X	I	A	I	I	I	I	I	I	I	I	T					

BUCHANAN RUBBER CHEMICAL RESISTANCE GUIDE

Chemical	HOSE TEMPERATURE (F)	PVC TEMPERATURE (F)	HOSE AND SHEET RUBBER									THERMOPLASTIC HOSE			COUPLINGS					GASKETS						
			UHMWPE	SBR	BUTYL	HYPALON	NATURAL	VITON	NITRILE	EPDM	XLPE	TPU	PVC	TPR	304SS	316SS	ALUMINUM	BRASS	NYLON	POLYPROPYLENE	TEFLON	SILICONE	VITON	BUNA	EPDM	
Dimethyl Sulfide			N/R																						→	
Dinitrobenzene	100	70	A	X	X	X	X	A	X	I	A	I	X	I	I	I	I	I	I	I	T		V			
Diocetyl Adipate	100	70	A	I	A	X	X	X	X	B	A	I	X	I	I	I	I	I	I	I	T					
Diocetyl Amine	100	70	A	I	A	X	B	I	B	I	A	I	I	I	I	I	I	I	I	I	T					
Diocetyl Phthalate	100	70	A	I	B	X	X	A	X	X	A	X	X	X	I	A	I	I	I	I	T		V			
Diocetyl Sebacate	100	70	A	I	A	X	X	X	X	B	A	I	X	I	I	I	I	I	I	I	T		V			
Dioxane	100	70	A	X	B	X	X	X	X	X	A	I	I	I	I	A	I	I	I	I	T					
Dioxolane	100	70	A	X	X	X	X	I	X	X	A	I	I	I	I	I	I	I	I	I	T					
Diphenyl Phthalate	100	70	A	I	A	X	X	X	X	I	A	I	X	I	I	I	I	I	I	I	T					
Dipropyl Ketone	100	70	A	X	B	X	X	X	X	I	A	I	X	I	I	I	I	I	I	I	T					
Dipropylamine	100	70	A	A	A	X	B	I	B	I	A	I	I	I	I	I	I	I	I	I	T					
Dipropylene Glycol	100	70	A	A	A	A	A	A	A	I	A	I	I	I	I	I	I	I	I	I	T		V	B		
Disodium Phosphophate	100	70	A	I	A	A	A	I	A	I	A	A	A	B	I	A	I	B	A	A	T			B		
Divinyl Benzene	100	70	A	X	X	X	X	A	X	X	A	I	X	I	I	I	I	I	I	I	T		V			
Dodecyl Benzene	100	70	A	X	X	X	X	A	X	X	A	I	X	I	I	I	I	I	I	I	T		V			
Dodecyl Toluene	100	70	A	X	X	X	X	A	X	X	A	I	I	I	I	I	I	I	I	I	T		V			
Dow-Per	100	70	A	X	X	X	X	A	X	X	A	I	I	I	I	I	I	I	I	I	T		V			
Dowtherm® A	100	70	A	I	I	X	X	A	X	X	A	I	I	I	I	A	I	I	I	I	T		V			
Dowtherm® E	100	70	A	I	X	X	X	A	X	X	A	I	I	I	I	I	X	I	I	I	T		V			
Dowtherm® SR-1	100	70	A	I	A	A	A	A	A	I	A	I	I	I	I	I	I	I	I	I	T		V	B		
Endolene	100	70	I	I	I	I	I	I	I	I	I	I	I	I	I	I	I	I	I	I	T					
Epichlorohydrin			N/R																						→	
Ethanol	100	70	A	I	A	A	A	B	A	A	A	A	A	A	A	B	A	A	A	A	T			B	E	
Ethanol Amine	100	70	A	I	A	B	B	I	B	B	A	B	A	I	I	A	B	I	I	I	T			B		
Ethyl Acetate	100	70	A	X	B	X	X	X	X	A	A	X	X	B	A	A	A	A	A	X	T				E	
Ethyl Acetoacetate	100	70	A	X	B	X	X	X	X	B	A	I	X	I	I	B	I	I	I	I	T					
Ethyl Acrylate	100	70	A	X	X	X	X	X	X	B	X	X	X	I	I	A	A	A	I	I	T					
Ethyl Alcohol	100	70	A	I	A	A	A	A	A	A	A	A	A	A	A	B	A	A	I	I	T		S	V	B	E
Ethyl Aldehyde			N/R																						→	
Ethyl Aluminum Dichloride	100	70	X	I	X	X	X	B	X	X	B	I	I	I	I	I	I	I	I	I	T		V			
Ethyl Benzene	100	70	A	X	X	X	X	A	X	X	A	I	X	X	I	A	A	X	I	I	T		V			
Ethyl Butanol	100	70	A	I	A	A	A	B	A	A	A	I	A	I	I	I	I	I	I	I	T			B	E	
Ethyl Butyl Acetate	100	70	A	I	A	B	X	X	X	I	A	I	X	I	I	I	I	I	I	I	T					
Ethyl Butyl Alcohol	100	70	A	A	A	A	A	B	A	A	A	I	A	I	I	I	I	I	I	I	T			B	E	
Ethyl Butyl Amine	100	70	A	B	A	X	B	I	B	I	I	I	I	I	I	I	I	I	I	I	T			B		
Ethyl Butyl Ketone	100	70	A	X	B	X	X	X	X	I	A	I	X	I	I	I	I	I	I	I	T					
Ethyl Butyraldehyde	100	70	A	I	B	X	X	X	X	I	A	I	I	I	I	I	I	I	I	I	T					
Ethyl Chloride			N/R											→	I	A	I	I	A	X	T			V	B	
Ethyl Dichloride	100	70	B	X	X	X	X	B	X	X	B	X	X	X	I	I	I	I	I	I	T		V			
Ethyl Ether			N/R																						→	
Ethyl Formate	100	70	A	X	B	X	X	X	X	B	A	I	X	I	I	A	I	I	I	I	T		V			
Ethyl Hexanol	100	70	A	A	A	A	A	B	A	A	A	I	I	I	I	I	I	I	I	I	T			B	E	
Ethyl Hexoic Acid	100	70	A	I	X	B	X	I	X	I	A	I	I	I	I	I	I	I	I	I	T					
Ethyl Hexyl Acetate	100	70	A	I	A	B	X	X	X	I	A	I	X	I	I	I	I	I	I	I	T					

BUCHANAN RUBBER CHEMICAL RESISTANCE GUIDE

Chemical	HOSE TEMPERATURE (F)	PVC TEMPERATURE (F)	HOSE AND SHEET RUBBER									THERMOPLASTIC HOSE			COUPLINGS					GASKETS					
			UHMWPE	SBR	BUTYL	HYPALON	NATURAL	VITON	NITRILE	EPDM	XLPE	TPU	PVC	TPR	304SS	316SS	ALUMINUM	BRASS	NYLON	POLYPROPYLENE	TEFLON	SILICONE	VITON	BUNA	EPDM
Ethyl Hexyl Alcohol	100	70	A	I	A	A	A	B	A	A	A	I	A	I	I	I	I	I	I	T			B	E	
Ethyl Iodide	100	70	X	I	X	X	X	B	X	X	B	X	X	X	I	I	I	I	I	T		V			
Ethyl Isobutyl Ether	100	70	A	I	X	B	X	I	B	X	A	I	X	I	I	I	I	I	I	T					
Ethyl Methyl Ketone	100	70	A	X	B	X	X	X	X	I	A	X	X	X	I	A	A	A	I	I	T				
Ethyl Oxalate	100	70	A	A	A	X	A	I	X	X	A	I	X	I	I	I	I	I	I	T		V			
Ethyl Phthalate	100	70	A	X	A	X	X	X	X	I	A	I	X	I	I	I	I	I	I	T					
Ethyl Propyl Ether	100	70	A	X	X	B	X	I	B	X	A	I	X	I	I	I	I	I	I	T			B		
Ethyl Propyl Ketone	100	70	A	X	B	X	X	X	X	I	A	X	X	I	I	I	I	I	I	T					
Ethyl Silicate	100	70	A	B	A	I	X	I	A	I	A	I	I	I	A	I	I	I	I	T			B		
Ethyl Sulfate	100	70	A	X	B	X	X	X	X	I	A	I	I	I	X	X	I	I	I	T	S		B		
Ethylamine			N/R																					▶	
Ethylene Bromide	100	70	X	X	X	X	X	B	X	X	B	X	X	X	I	A	X	I	I	T		V			
Ethylene Chloride	100	70	B	X	X	X	X	B	X	X	B	X	X	X	A	A	B	I	A	X	T		V		
Ethylene Diamine	100	70	A	B	A	X	B	I	B	B	A	I	I	I	A	I	I	I	I	T			B		
Ethylene Dibromide	100	70	X	X	X	X	X	B	X	X	B	X	X	X	I	A	X	I	I	T		V			
Ethylene Dichloride	100	70	B	X	X	X	X	B	X	X	B	X	X	X	A	A	B	I	A	X	T		V		
Ethylene Glycol	150	70	A	A	A	A	A	A	A	A	A	A	A	A	A	A	A	I	A	X	T	S	V	B	E
Ethylhexil Phosphorodieth	100	70	I	I	X	X	I	I	A	X	X	I	I	I	I	I	I	I	I	I	T			B	
Ex-Tri	100	70	A	I	X	X	X	A	X	I	A	I	I	I	I	I	I	I	I	I	T		V		
Ferric Bromide	150	70	A	A	A	A	A	A	A	A	A	A	A	B	I	I	I	I	I	T		V	B	E	
Ferric Chloride	150	70	A	A	A	A	A	A	A	A	A	A	A	A	I	X	X	X	X	A	T	S	V	B	E
Ferric Sulfate	150	70	A	A	A	A	A	A	A	A	A	A	A	A	A	X	X	X	X	A	T		V	B	E
Ferrous Acetate	100	70	A	X	A	A	X	X	X	I	A	A	A	I	I	I	I	I	I	T					
Ferrous Chloride	150	70	A	A	A	A	A	B	A	A	A	A	A	B	X	I	X	X	X	A	T			B	E
Ferrous Hydroxide	100	70	A	B	A	B	A	X	B	I	A	I	A	I	B	I	I	I	I	T					
Ferrous Sulfate	150	70	A	A	A	A	A	A	A	A	A	A	A	A	A	B	X	X	X	A	T		V	B	E
Fluoboric Acid 65%	150	70	B	I	A	A	A	I	I	I	I	I	I	I	I	I	X	X	X	A	T				
Fluorine (wet)	100	70	X	I	X	X	X	X	X	X	X	I	I	I	I	X	X	X	X	I	T				
Fluosilicic Acid 50%	150	70	B	I	A	A	A	I	I	I	I	I	I	I	A	X	X	X	I	T					
Formaldehyde 40%	100	70	A	I	A	A	B	B	A	A	A	I	I	I	I	A	B	I	X	A	T			B	E
Formalin	100	70	A	I	A	A	B	A	A	A	A	I	I	A	I	A	B	I	I	T		V	B	E	
Formic Acid	100	70	A	A	A	X	B	X	X	A	B	I	I	I	A	B	I	X	X	A	T		V		E
Freon® 12	100	70	A	I	X	X	X	B	B	X	B	B	X	I	A	I	I	I	I	T					
Freon® 22	100	70	A	I	X	X	X	X	X	I	B	X	X	X	I	A	I	I	I	T					
Fuel A (ASTM)	100	70	B	I	X	X	X	A	A	X	B	A	B	I	I	A	A	A	I	T		V	B		
Fuel B (ASTM)	100	70	B	I	X	X	X	A	A	X	B	A	B	X	I	I	I	I	I	T		V	B		
Fuel Oil	100	70	A	X	X	X	X	A	A	X	B	A	B	X	I	A	A	I	A	X	T		V	B	
Furfural	100	70	A	X	A	I	I	X	X	B	A	X	X	X	A	A	A	X	A	X	T				
Furfuryl Alcohol	100	70	A	X	X	I	I	X	I	I	A	I	I	I	I	A	A	I	I	T					
Gallic Acid	100	70	A	A	B	I	A	I	I	B	I	I	I	I	A	B	I	I	A	T	S				
Gasoline	100	70	B	I	X	X	X	A	A	X	B	X	X	X	A	A	I	I	A	X	T		V	B	
Glacial Acetic Acid	100	70	A	I	B	X	X	X	X	A	A	X	B	I	I	A	B	X	I	T				E	
Gluconic Acid	100	70	A	X	X	B	X	I	X	I	A	I	I	I	I	X	X	A	I	T					
Glycerin	100	70	A	I	A	A	A	A	A	A	B	A	A	B	I	A	A	A	A	A	T	S	V	B	E

BUCHANAN RUBBER CHEMICAL RESISTANCE GUIDE

Chemical	HOSE TEMPERATURE (F)	PVC TEMPERATURE (F)	HOSE AND SHEET RUBBER									THERMOPLASTIC HOSE			COUPLINGS					GASKETS				
			UHMWPE	SBR	BUTYL	HYPALON	NATURAL	VITON	NITRILE	EPDM	XLPE	TPU	PVC	TPR	304SS	316SS	ALUMINUM	BRASS	NYLON	POLYPROPYLENE	TEFLON	SILICONE	VITON	BUNA
Glyphosate	100	70	A	I	I	I	I	I	A	I	I	I	I	I	I	I	I	I	I					E
Graffinite	100	70	I	I	X	X	X	X	A	X	X	I	I	I	I	I	I	I	I				B	
Grease	100	70	A	X	X	X	X	A	A	X	B	A	A	B	A	A	A	A	I	T		V	B	
Green Sulfate Liquor	150	70	A	A	A	A	A	I	A	A	A	I	I	I	A	X	X	I	I	T	S		B	E
Heptanal	100	70	A	I	X	X	X	X	X	I	A	I	I	I	I	I	I	I	I	T			B	
Heptane	100	70	A	X	X	X	X	A	A	X	B	A	A	X	I	A	A	I	A	X	T	V	B	
Heptane Carboxylic Acid	100	70	A	X	X	B	X	A	X	I	A	I	I	I	I	I	I	I	I	T		V		
Hexaldehyde	100	70	A	X	X	X	X	X	X	X	A	I	I	I	I	A	A	I	I	T				
Hexane	100	70	B	X	X	X	X	A	A	X	B	A	A	X	A	A	A	A	X	T		V	B	
Hexanol	100	70	A	I	A	A	A	B	A	A	A	B	A	B	I	A	I	I	I	T			B	E
Hexyl Methyl Ketone	100	70	A	X	B	X	X	X	X	I	A	I	X	I	I	I	I	I	I	T				
Hexyl-Alcohol	100	70	A	I	A	A	A	B	A	X	A	I	I	I	I	A	I	I	I	T			B	
Hexylamine	100	70	A	B	B	X	X	X	X	I	A	I	I	I	I	I	I	I	I	T				
Hexylene	100	70	X	X	X	X	X	A	A	X	X	I	I	I	I	I	I	I	I	T		V	B	
Hexylene Glycol	150	70	A	A	A	A	A	A	A	I	A	I	B	I	I	A	B	A	I	T		V	B	
Hi-Tri	100	70	A	I	X	X	X	A	X	X	A	I	I	I	I	I	I	I	I	T		V		
Hydrobromic Acid (37%)	150	70	B	I	A	A	A	I	X	A	I	I	I	I	X	X	X	X	A	T				E
Hydrochloric Acid (37%)	125	70	A	I	A	X	B	X	X	B	A	I	I	I	X	X	X	I	I	T				
Hydrochloric Acid -38% Conc.	125	70	I	I	A	X	B	I	X	B	A	I	I	I	X	X	X	I	I	T				
Hydrofluoric Acid (10%)	125	70	A	I	A	A	X	I	X	I	A	I	I	I	A	X	X	I	I	T				
Hydrofluosilicic Acid	150	70	B	I	B	A	A	I	I	A	I	B	B	I	X	A	X	I	I	T				E
Hydrogen Dioxide 10%	100	70	B	I	X	X	X	A	X	I	I	I	A	I	I	A	B	X	I	T		V		
Hydrogen Dioxide over 10%	100	70	B	I	X	X	X	I	X	X	I	I	A	I	I	I	X	I	I	T				
Hydrogen Gas			N/R												A	A	A	A	X	A	T	V	B	
Hydrogen Peroxide 10% to 50%	100	70	B	I	X	X	X	A	X	I	I	I	I	I	I	B	I	X	A	T	S	V		
Hydrogen Peroxide over 50%	100	70	X	I	X	X	X	X	X	X	I	I	I	I	A	I	X	I	I	T				
Iodine	100	70	A	X	I	A	I	I	I	I	B	X	X	X	I	I	X	X	A	T		V	B	
Iron Acetate	100	70	A	X	A	A	X	X	X	I	A	I	A	I	I	I	I	I	I	T	S			
Iron Hydroxide	100	70	A	B	A	B	X	X	B	I	A	I	A	I	I	I	I	I	I	T				
Iron Salts	150	70	A	A	A	A	A	A	A	A	A	I	A	B	I	I	I	I	I	T		V	B	E
Iron Sulfate	150	70	A	A	A	A	A	A	A	A	I	A	A	I	I	I	I	I	I	T		V	B	E
Iron Sulfide	150	70	A	A	A	A	A	A	A	A	I	A	I	I	I	I	I	I	I	T		V	B	E
Isoamyl Acetate	100	70	A	X	A	B	X	X	X	A	I	X	I	I	I	I	I	I	I	T				
Isoamyl Alcohol	100	70	A	A	A	A	A	B	A	A	A	I	A	I	I	A	I	A	I	T			B	E
Isoamyl Bromide	100	70	B	X	X	X	X	B	X	X	B	X	X	I	I	I	I	I	I	T		V		
Isoamyl Butyrate	100	70	B	X	X	X	X	X	X	I	B	I	X	I	I	I	I	I	I	T				
Isoamyl Chloride	100	70	X	X	X	X	X	B	X	I	X	I	X	I	I	I	I	I	I	T		V		
Isoamyl Ether	100	70	A	X	X	B	X	I	B	X	A	I	X	I	I	I	I	I	I	T				
Isoamyl Phthalate	100	70	A	X	A	X	X	X	X	I	A	I	X	I	I	I	I	I	I	T				
Isobutane			N/R																					
Isobutanol	100	70	A	I	A	A	A	B	A	A	A	I	A	A	I	A	I	I	I	T	S		B	E
Isobutyl Acetate	100	70	A	X	A	B	X	X	X	X	A	I	X	I	I	A	B	I	I	T				
Isobutyl Alcohol	100	70	A	I	A	A	A	B	X	A	A	I	A	A	A	I	I	A	A	T	S			E
Isobutyl Aldehyde	100	70	A	X	B	X	X	X	X	I	A	I	I	I	I	I	I	I	I	T				

BUCHANAN RUBBER CHEMICAL RESISTANCE GUIDE

Chemical	HOSE TEMPERATURE (F)	PVC TEMPERATURE (F)	HOSE AND SHEET RUBBER									THERMOPLASTIC HOSE			COUPLINGS					GASKETS					
			UHMWPE	SBR	BUTYL	HYPALON	NATURAL	VITON	NITRILE	EPDM	XLPE	TPU	PVC	TPR	304SS	316SS	ALUMINUM	BRASS	NYLON	POLYPROPYLENE	TEFLON	SILICONE	VITON	BUNA	EPDM
Isobutyl Amine	100	70	A	B	B	X	X	X	X	I	A	I	I	I	I	I	I	I	T						
Isobutyl Bromide	100	70	B	X	X	X	X	B	X	X	X	I	I	I	I	I	I	I	T		V				
Isobutyl Carbinol	100	70	A	A	A	A	A	B	A	A	A	I	I	I	A	I	A	I	T			B	E		
Isobutyl Chloride	100	70	B	X	X	X	X	B	X	X	X	I	I	I	I	I	I	I	T		V				
Isobutyl Ether	100	70	A	X	X	B	X	I	X	X	A	I	I	I	I	I	I	I	T			B			
Isobutylene	100	70	A	X	X	X	X	A	X	X	A	I	I	I	I	I	I	I	T		V				
Isooctane	100	70	B	X	X	X	X	A	A	X	B	I	B	I	A	A	A	I	T	S	V	B			
Isopentane			N/R																					▶	
Isophorone	100	70	B	I	A	I	I	I	X	A	B	I	I	I	I	B	A	I	T					E	
Isopropanol	100	70	A	I	A	A	A	B	A	A	A	I	A	A	I	A	I	I	T	S	V	B	E		
Isopropanol Amine	100	70	A	I	A	X	B	X	B	I	A	I	I	I	I	I	I	I	T			B			
Isopropyl Acetate	100	70	A	X	A	X	X	X	X	X	A	X	X	I	A	I	I	I	T						
Isopropyl Alcohol	100	70	A	A	A	A	A	B	A	A	A	A	A	B	A	A	I	A	T	S		B	E		
Isopropyl Amine	100	70	A	X	B	X	X	X	X	I	A	I	I	I	I	I	I	I	T						
Isopropyl Benzene	100	70	A	X	X	X	X	A	X	X	A	I	X	X	I	I	I	I	T		V				
Isopropyl Chloride			N/R																					▶	
Isopropyl Ether	100	70	A	X	X	B	X	I	X	X	A	I	I	I	I	I	I	A	T			B			
Isopropyl Toluene	100	70	A	X	X	X	X	A	X	X	A	I	I	I	I	I	I	I	T		V				
Jet Fuels			N/R											▶	B	B	B	A	X	X	T	V			
Kerosene	100	70	A	X	X	X	X	A	B	X	A	X	B	X	A	A	A	I	T		V	B			
Lauryl Alcohol	100	70	A	A	A	A	A	B	A	A	A	I	I	I	I	I	I	I	T			B	E		
Lead Acetate	100	70	A	X	A	X	X	X	X	B	A	A	A	B	A	A	X	X	T						
Lead Sulfate	150	70	A	A	A	A	A	A	A	A	A	I	X	I	A	A	X	X	T		V	B	E		
Ligroin	100	70	A	X	X	X	X	A	A	X	A	I	I	I	I	A	A	I	T		V	B			
Linseed Oil	100	70	A	X	A	B	X	A	A	B	I	A	A	X	A	A	I	A	T	S	V	B			
Liquefied Natural Gas (LNG)			N/R																					▶	
Liquefied Petroleum Gas (LPG)			N/R																					▶	
Lubricating Oils	100	70	A	X	X	X	X	A	A	X	A	A	B	I	I	A	A	A	T		V	B			
M.E.K.	100	70	A	I	X	X	X	X	X	X	A	X	X	X	I	X	X	X	T						
Magnesium Acetate	100	70	A	X	A	A	X	X	X	I	A	I	A	I	I	I	I	I	T						
Magnesium Chloride	150	70	A	A	A	A	A	A	A	A	A	A	A	A	A	X	I	X	T	S	V	B	E		
Magnesium Hydrate	150	70	A	A	A	B	A	B	B	I	A	I	A	B	I	A	X	I	T						
Magnesium Hydroxide	150	70	A	A	A	B	A	B	B	A	A	A	A	A	A	X	I	X	T		V	B	E		
Magnesium Sulfate	150	70	A	A	A	A	A	A	A	B	A	A	A	A	A	A	I	X	T	S	V	B			
Maleic Acid	100	70	A	X	X	X	X	I	X	I	B	I	I	I	A	A	B	X	T		V				
Malic Acid	150	70	B	A	I	A	A	I	I	I	I	B	A	B	A	A	B	X	T	S	V	B			
Manganese Sulfate	150	70	A	A	A	A	X	A	A	A	A	I	A	I	I	A	I	I	T		V	B	E		
Manganese Sulfide	150	70	A	A	A	A	X	A	A	A	A	I	A	I	I	I	I	I	T		V	B	E		
Manganese Sulfite	150	70	A	A	A	A	X	A	A	A	A	I	A	I	I	I	I	I	T		V	B	E		
Mesityl Oxide	100	70	A	I	B	X	X	X	X	A	A	I	I	I	A	I	I	I	T						
Methallyl Alcohol	100	70	A	I	A	A	A	B	A	A	A	I	A	I	I	I	I	I	T			B	E		
Methanol	100	70	A	I	A	A	A	X	A	A	A	A	A	A	A	I	I	A	T			B	E		
Methyl (Wood) Alcohol	100	70	A	I	A	A	A	X	A	A	A	B	B	A	I	A	I	I	T	S		B	E		
Methyl Acetate	100	70	A	X	A	B	X	X	X	A	A	X	X	X	I	A	I	I	T					E	

BUCHANAN RUBBER CHEMICAL RESISTANCE GUIDE

Chemical	HOSE TEMPERATURE (F)	PVC TEMPERATURE (F)	HOSE AND SHEET RUBBER									THERMOPLASTIC HOSE			COUPLINGS					GASKETS				
			UHMWPE	SBR	BUTYL	HYPALON	NATURAL	VITON	NITRILE	EPDM	XLPE	TPU	PVC	TPR	304SS	316SS	ALUMINUM	BRASS	NYLON	POLYPROPYLENE	TEFLON	SILICONE	VITON	BUNA
Methyl Acetoacetate	100	70	A	I	B	X	X	X	X	I	A	I	X	I	I	I	I	I	I	T				
Methyl Acetone			N/R																					▶
Methyl Amyl Acetate	100	70	B	I	A	B	X	X	X	A	X	X	X	I	I	I	I	I	I	T				
Methyl Amyl Alcohol	100	70	A	I	A	A	A	B	A	A	A	I	A	I	A	I	I	I	I	T			B	E
Methyl Amyl Carbinol	100	70	A	I	A	A	A	B	A	A	A	I	I	I	I	I	I	I	I	T			B	E
Methyl Amyl Ketone	100	70	A	I	B	X	X	X	X	I	A	I	X	I	I	I	I	I	I	T				
Methyl Benzene	100	70	A	I	X	X	X	A	X	X	A	I	X	X	A	A	A	I	I	T		V		
Methyl Butanol	100	70	A	I	A	A	A	B	A	I	A	I	B	X	I	A	I	A	I	T			B	
Methyl Butanone	100	70	A	I	B	X	X	X	X	B	A	I	I	I	I	I	I	I	I	T				
Methyl Butyl Ketone	100	70	A	X	B	X	X	X	X	I	A	I	X	I	I	A	B	I	I	T				
Methyl Carbitol	100	70	A	I	A	A	X	I	X	I	A	I	I	I	I	I	I	I	I	T				
Methyl Cellosolve	100	70	A	X	A	A	X	I	X	A	A	I	B	I	I	A	B	A	I	A	T			E
Methyl Chloride			N/R																					▶
Methyl Cyclohexane	100	70	A	X	X	X	X	B	X	X	B	I	I	I	I	I	I	I	I	T		V		
Methyl Ethyl Ketone (M.E.K.)	100	70	A	I	X	X	X	X	X	X	A	I	I	I	I	X	X	X	A	X	T			
Methyl Hexanol	100	70	A	A	A	A	B	A	A	A	A	I	I	I	I	I	I	I	I	T		V	B	E
Methyl Hexanone	100	70	A	I	B	X	X	X	X	I	A	I	I	I	I	I	I	I	I	T				
Methyl Hexyl Ketone	100	70	A	X	B	X	X	X	X	I	A	I	X	I	I	I	I	I	I	T				
Methyl Isobutyl Carbinol	100	70	A	B	A	A	A	B	A	A	A	I	I	I	I	B	I	I	I	T			B	E
Methyl Isobutyl Ketone (MIBK)	100	70	A	X	X	X	X	X	X	X	A	I	I	I	I	X	X	X	A	X	T			
Methyl Isopropyl Ketone	100	70	A	X	B	X	X	X	X	B	A	I	X	I	I	A	I	I	A	I	T			
Methyl Normal Amyl Ketone	100	70	A	I	B	X	X	X	X	I	A	I	X	I	I	I	I	I	I	T				
Methyl Propyl Carbinol	100	70	A	I	A	A	A	B	A	A	A	I	I	I	I	I	I	I	I	T			B	E
Methyl Propyl Ether	100	70	A	X	X	B	X	I	X	X	A	I	I	I	I	I	I	I	I	T				
Methyl Propyl Ketone	100	70	A	X	B	X	X	X	X	I	A	I	X	I	I	I	I	I	I	T				
MTBE 100% Concentrate	100	70	X	I	X	X	X	X	X	X	A	I	I	I	I	I	I	I	I	T				
Methylallyl Acetate	100	70	A	I	A	B	X	X	X	A	A	I	X	I	I	I	I	I	I	T				E
Methylallyl Chloride	100	70	A	I	X	X	X	X	X	I	B	X	X	X	I	I	I	I	I	T				
Methyldiethanolamine	100	70	A	I	X	X	X	X	X	A	A	I	I	I	I	I	I	I	I	T			B	
Methylene Bromide	100	70	B	X	X	X	X	B	X	X	B	X	X	I	I	I	I	I	I	T		V		
Methylene Chloride			N/R											▶	I	I	I	B	A	X	T			
Metribuzin	100	70	A	I	I	I	I	I	A	I	I	I	I	I	I	I	I	I	I	T				E
MIBK	100	70	A	I	X	X	X	X	X	X	A	I	X	X	I	X	X	X	I	I	T			
Mineral Spirits	100	70	A	X	X	X	X	B	A	X	A	I	B	I	I	A	A	I	I	T			B	
Monochloroacetic Acid	100	70	A	I	X	X	B	I	X	X	A	I	I	I	I	A	X	X	I	I	T			
Monochlorobenzene	100	70	B	X	X	X	X	A	X	X	B	X	X	X	I	A	B	B	I	I	T		V	
Monochlorodifluoromethane	100	70	I	X	X	X	X	X	X	I	I	I	I	I	I	A	I	I	I	T				
Monoethanol Amine	100	70	A	I	A	X	B	I	B	B	A	I	I	I	I	A	B	I	I	T				
Monoethyl Amine			N/R																					▶
Muriatic Acid	125	70	A	I	X	X	A	I	X	X	A	I	I	I	I	X	X	X	X	A	T			
N/Methylpyrrolidone	100	70	A	I	X	X	X	X	X	X	A	I	I	I	I	I	I	I	I	I	T			
Naphtha	100	70	A	X	X	X	X	A	A	X	A	B	B	X	I	A	A	I	I	T		V	B	
Naphthalene	100	70	A	I	X	X	X	A	X	X	A	B	X	X	I	A	B	I	A	A	T		V	
Natural Gas			N/R																					▶

BUCHANAN RUBBER CHEMICAL RESISTANCE GUIDE

Chemical	HOSE TEMPERATURE (F)	PVC TEMPERATURE (F)	HOSE AND SHEET RUBBER									THERMOPLASTIC HOSE			COUPLINGS					GASKETS					
			UHMWPE	SBR	BUTYL	HYALON	NATURAL	VITON	NITRILE	EPDM	XLPE	TPU	PVC	TPR	304SS	316SS	ALUMINUM	BRASS	NYLON	POLYPROPYLENE	TEFLON	SILICONE	VITON	BUNA	EPDM
Neohexane	100	70	A	I	X	X	X	A	A	X	A	I	I	I	I	A	A	I	I	I	T		V	B	
Neu-Tri	100	70	A	I	X	X	X	A	X	X	A	I	I	I	I	I	I	I	I	I	T		V		
Nickel Chloride	150	70	A	A	A	A	A	A	A	A	A	A	B	A	B	X	X	X	A	T	S	V	B	E	
Nickel Nitrate	150	70	A	A	A	A	A	A	A	A	A	A	B	I	B	X	X	I	I	T		V	B	E	
Nickel Sulfate	150	70	A	A	A	A	A	A	A	A	A	A	A	A	A	X	X	X	A	T	S	V	B	E	
Nitric Acid 25%	100	70	B	I	B	X	X	X	X	X	B	I	I	I	I	A	X	X	I	I	T		V		
Nitric Acid 37%	100	70	X	I	X	X	X	X	X	X	X	I	I	I	I	A	X	X	I	I	T		V		
Nitric Acid 40%-60%	100	70	X	I	X	X	X	X	X	X	X	I	I	I	I	A	X	X	I	I	T		V		
Nitric Acid 70%	100	70	X	I	X	X	X	X	X	X	X	I	I	I	I	B	X	X	I	I	T				
Nitro Benzene	100	70	A	I	X	X	X	B	X	X	A	X	X	X	I	A	B	X	A	A	T				
Nitrogen Gas	100	70	A	A	A	A	A	A	A	A	A	A	A	A	I	A	I	I	I	I	T	S	V	B	E
Nitrous Oxide	100	70	A	A	A	A	A	A	A	A	A	A	B	I	A	I	X	I	I	T	S	V	B	E	
Nonenes	100	70	A	I	X	X	X	A	A	X	A	I	I	I	I	I	I	I	I	I		V	B		
Octadecanoic Acid	100	70	A	X	B	X	X	I	A	B	A	I	I	I	I	A	B	A	I	T			B		
Octane	100	70	B	X	X	X	X	A	A	X	B	I	I	I	I	B	I	B	I	T		V	B		
Octanol	100	70	A	I	A	A	A	B	A	X	A	I	A	B	I	A	I	I	I	T			B		
Octyl Acetate	100	70	A	X	A	A	X	X	X	I	A	I	X	I	I	I	I	I	I	T					
Octyl Alcohol	100	70	A	I	A	A	A	B	A	X	A	I	I	I	I	A	I	I	A	T			B		
Octyl Aldehyde	100	70	A	I	X	X	X	X	X	I	A	I	I	I	I	I	I	I	I	T					
Octyl Amine	100	70	A	B	B	X	X	X	X	I	A	I	I	I	I	I	I	I	I	T					
Octyl Carbinol	100	70	A	A	A	A	A	B	A	A	A	I	I	I	I	I	I	I	I	T			B	E	
Octylene Glycol	100	70	A	A	A	A	A	A	A	A	A	I	I	I	I	I	I	I	I	T		V	B	E	
Oil Petroleum	100	70	B	I	X	X	X	A	A	X	A	A	B	I	I	A	A	X	I	T		V	B		
Oleic Acid	100	70	A	X	B	X	X	I	A	X	A	B	B	B	A	A	B	X	A	T			B		
Oleum	100	70	X	I	X	X	X	X	X	X	X	X	X	X	I	X	X	X	X	T		V			
Organic Fatty Acids	100	70	A	I	X	X	X	X	A	X	A	I	I	I	I	A	I	I	I	T			B		
Orthodichlorobenzene	100	70	A	X	X	X	X	A	X	X	A	I	X	I	I	I	I	I	I	T		V			
Orthodichlorobenzol	100	70	A	I	X	X	X	A	X	X	A	I	X	I	I	I	I	I	I	T		V			
Orthoxylene	100	70	B	I	X	X	X	A	X	X	A	I	I	I	I	I	I	I	I	T		V			
Oxalic Acid	100	70	A	B	A	X	X	I	X	B	I	A	A	A	I	A	B	X	X	T	S				
Oxygen			N/R													B	B	B	B	T		V	B		
Ozone	100	70	A	B	B	B	X	I	X	A	I	B	B	B	I	I	I	I	I	T	S			E	
Palmitic Acid	100	70	A	X	A	B	X	I	A	B	B	B	B	I	A	I	X	X	A	T	S		B		
Papermakers Alum	150	70	A	I	A	A	A	A	A	A	A	I	A	I	I	I	I	I	I	T		V	B	E	
Paradichlorobenzol	100	70	B	I	X	X	X	A	X	X	A	I	X	I	I	I	I	I	I	T		V			
Paraffin	150	70	A	X	B	X	X	A	A	X	X	B	A	I	A	A	A	A	A	T		V	B		
Paraldehyde	100	70	A	I	B	X	X	X	X	B	A	I	I	I	I	A	A	I	I	T					
Paraxylene	100	70	A	I	X	X	X	A	X	X	A	I	I	I	I	I	I	I	I	T		V			
Pelargonic Acid	100	70	A	I	A	X	X	I	A	I	A	I	I	I	I	I	I	I	I	T			B		
Pentachloroethane	100	70	A	I	X	X	X	A	X	X	A	I	I	I	I	A	B	X	I	T		V			
Pentane	100	70	X	X	X	X	X	A	A	X	B	B	B	X	B	B	A	A	A	T		V	B		
Pentanol	100	70	A	I	A	A	A	B	A	A	A	I	A	I	I	I	I	I	I	T			B	E	
Pentanone	100	70	A	I	B	X	X	X	X	I	A	I	I	I	I	I	I	I	I	T					
Perchloroethylene	100	70	B	X	X	X	X	A	X	X	A	X	X	X	A	A	B	X	X	T		V			

BUCHANAN RUBBER CHEMICAL RESISTANCE GUIDE

Chemical	HOSE TEMPERATURE (F)	PVC TEMPERATURE (F)	HOSE AND SHEET RUBBER									THERMOPLASTIC HOSE			COUPLINGS					GASKETS					
			UHMWPE	SBR	BUTYL	HYPALON	NATURAL	VITON	NITRILE	EPDM	XLPE	TPU	PVC	TPR	304SS	316SS	ALUMINUM	BRASS	NYLON	POLYPROPYLENE	TEFLON	SILICONE	VITON	BUNA	EPDM
Petroleum - Crude	100	70	A	I	X	X	X	A	A	X	A	A	B	X	I	A	A	X	I	I	T		V	B	
Petroleum Ether (Ligroin)	100	70	A	I	X	X	X	A	A	X	A	A	B	X	I	A	A	I	I	I	T		V	B	
Petroleum Oils	100	70	A	X	X	X	X	A	A	X	A	A	B	X	I	A	A	X	I	I	T		V	B	
Phenol	125	70	A	B	A	X	X	A	X	X	A	X	X	X	I	A	B	B	I	I	T		V		
Phenolsulfonic Acid	100	70	X	X	X	X	X	X	X	I	B	I	X	I	I	B	I	I	I	I	T				
Phenyl Chloride	100	70	A	X	X	X	X	A	X	X	A	I	I	X	I	A	B	I	I	I	T		V		
Phosphoric Acid 10%	150	70	A	I	A	A	A	X	A	A	A	A	A	A	I	A	X	X	X	A	T		V	B	E
Phosphoric Acid 10-85%	100	70	A	I	A	A	B	X	X	A	A	I	I	I	I	A	X	I	X	A	T		V		E
Pine Oil	100	70	A	X	X	X	X	A	X	X	A	I	I	I	A	A	I	X	I	I	T		V		
Pinene	100	70	A	X	X	X	X	A	B	X	A	I	I	I	B	I	I	I	I	I	T		V		
Polyethylene Glycol	150	70	A	A	A	A	A	A	A	A	A	B	B	B	I	I	I	I	I	I	T		V	B	E
Polypropylene Glycol	150	70	A	A	A	A	A	A	A	A	A	B	B	B	I	I	I	I	A	A	T		V	B	E
Potassium Acetate	100	70	A	X	A	B	X	X	X	B	A	I	A	B	I	A	X	X	A	A	T			B	
Potassium Bisulfate	150	70	A	A	A	A	A	A	A	A	A	A	A	B	I	A	I	X	I	I	T		V	B	E
Potassium Bisulfite	150	70	A	A	A	A	A	A	A	A	A	A	B	I	I	I	I	I	I	I	T		V	B	E
Potassium Carbonate	150	70	A	A	A	A	A	A	A	A	A	A	A	A	A	X	X	A	A	T	S	V	B	E	
Potassium Chloride	150	70	A	A	A	A	A	A	A	A	A	A	A	A	A	X	X	A	A	T	S	V	B	E	
Potassium Chromate	150	70	B	X	A	X	I	I	I	B	A	A	B	I	B	I	I	X	A	T		V	B		
Potassium Dichromate	150	70	B	X	A	X	I	I	I	B	A	A	B	A	A	B	X	X	A	T	S	V	B		
Potassium Hydrate	150	70	A	A	A	B	A	X	B	B	A	I	A	B	I	A	X	I	I	I	T	S			
Potassium Hydroxide	150	70	B	A	A	B	A	X	B	B	A	B	A	B	I	A	X	X	X	A	T				
Potassium Nitrate	150	70	A	A	A	A	A	A	A	A	A	A	B	A	A	B	A	X	A	T	S	V	B	E	
Potassium Permanganate	100	70	A	X	A	A	A	A	B	I	A	I	I	I	A	A	I	I	X	A	T	S	V		
Potassium Silicate	150	70	A	A	A	A	A	A	A	A	A	I	A	B	I	A	I	I	I	I	T	S	V	B	E
Potassium Sulfate	150	70	A	A	A	A	A	A	A	A	A	A	A	B	A	A	B	A	A	T	S	V	B	E	
Potassium Sulfide	150	70	A	A	A	A	A	A	A	A	A	A	A	B	A	A	X	X	I	I	T	S	V	B	E
Potassium Sulfite	150	70	A	A	A	A	A	A	A	A	A	A	A	B	I	A	I	X	I	I	T	S	V	B	E
Propane Gas			N/R												▶	B	B	A	A	X	X	T		V	B
Propanediol	100	70	A	A	A	A	A	A	A	A	A	I	A	B	I	I	I	I	I	I	T	S	V	B	E
Propanol	100	70	A	I	A	A	A	B	A	A	A	I	A	B	I	A	I	I	I	I	T		V	B	E
Propyl Acetate	100	70	A	X	A	B	X	X	X	X	A	I	X	I	I	A	I	I	I	I	T				
Propyl Alcohol	100	70	A	I	A	A	A	B	A	A	A	A	A	B	A	A	I	I	A	A	T			B	E
Propyl Aldehyde	100	70	A	X	B	X	X	X	X	I	A	I	I	I	I	I	I	I	I	I	T				
Propyl Chloride			N/R																						▶
Propylene Diamine	100	70	A	A	A	X	B	I	B	I	A	I	I	I	I	I	I	I	I	I	T			B	
Propylene Dichloride	100	70	B	X	X	X	X	B	X	X	B	X	X	X	I	A	X	I	I	I	T		V		
Propylene Glycol	100	70	A	A	A	A	A	A	A	A	A	A	I	A	A	I	I	A	I	T	S	V	B	E	
Propylene Tetramer	100	70	A	I	X	X	X	X	X	A	I	I	I	I	I	I	I	I	I	I				B	
Sea Water	100	70	A	I	A	A	A	A	A	A	A	A	A	A	A	A	I	X	A	A	T	S	V	B	E
Sewage	100	70	A	B	X	A	X	I	A	A	A	I	I	I	I	A	X	I	I	I	T	S		B	E
Silicate of Soda	100	70	A	I	A	A	A	A	A	A	A	I	B	A	I	A	X	X	I	I	T	S	V	B	E
Soap	100	70	A	I	X	X	X	X	A	X	X	I	I	I	I	A	X	X	A	A	T	S		B	
Soda Ash	100	70	A	I	A	A	A	A	A	A	A	A	A	A	I	A	X	I	I	I	T	S	V	B	E
Soda, Caustic	100	70	A	A	A	B	A	X	B	A	A	A	B	A	I	A	X	X	I	I	T	S			E

BUCHANAN RUBBER CHEMICAL RESISTANCE GUIDE

Chemical	HOSE TEMPERATURE (F)	PVC TEMPERATURE (F)	HOSE AND SHEET RUBBER									THERMOPLASTIC HOSE			COUPLINGS					GASKETS					
			UHMWPE	SBR	BUTYL	HYPALON	NATURAL	VITON	NITRILE	EPDM	XLPE	TPU	PVC	TPR	304SS	316SS	ALUMINUM	BRASS	NYLON	POLYPROPYLENE	TEFLON	SILICONE	VITON	BUNA	EPDM
			RATING DEFINITION A = CONTINUOUS SERVICE B = FOR INTERMITTENT USE I = INSUFFICIENT DATA X = DO NOT USE																						
Soda, Lime	100	70	A	A	A	B	A	X	B	A	A	I	B	I	I	I	I	I	I	T		V	B	E	
Soda, Niter	100	70	A	I	A	A	A	A	A	B	A	I	B	A	I	A	B	I	I	I	T		V	B	
Sodium Acetate	100	70	A	X	A	A	X	X	X	B	B	A	B	B	A	I	A	A	A	T	S				
Sodium Aluminate	100	70	A	A	A	A	A	A	A	A	A	I	A	B	I	A	I	A	I	T		V	B	E	
Sodium Bisulfate	150	70	A	A	A	A	A	A	A	A	A	A	A	A	A	X	X	X	A	T	S	V	B	E	
Sodium Bisulfite	150	70	A	A	A	A	A	A	A	A	A	I	A	A	I	A	X	X	I	I	T	S	V	B	E
Sodium Carbonate	150	70	A	A	A	A	A	A	A	A	A	A	A	A	I	A	X	I	A	A	T	S	V	B	E
Sodium Chloride (Brine)	150	70	A	I	A	A	A	A	A	A	A	A	A	A	I	A	X	I	I	T	S	V	B	E	
Sodium Chromate	150	70	X	X	A	X	I	I	I	I	X	I	A	I	A	A	A	A	A	T		V	B		
Sodium Dichromate	150	70	A	X	A	X	I	I	I	A	A	A	A	B	I	A	I	X	X	A	T			E	
Sodium Hydrate	150	70	A	I	A	B	A	X	B	A	A	I	A	I	I	B	X	X	I	I	T			E	
Sodium Hydrochlorite (20%)	100	70	A	I	B	X	X	B	X	I	B	I	I	I	I	I	I	I	I	T					
Sodium Hydrosulfide	100	70	A	I	X	X	X	X	A	X	A	I	I	I	I	I	B	I	I	I	T			B	
Sodium Hydroxide (50%)	150	70	A	I	A	B	A	X	B	A	A	I	I	I	I	A	X	X	X	A	T		B	E	
Sodium Hypochlorite	100	70	B	X	B	X	X	B	X	A	X	A	A	A	I	X	X	X	X	A	T	S	V		E
Sodium Nitrate	150	70	A	A	A	A	A	A	A	B	A	A	A	A	A	A	B	I	A	A	T	S	V	B	
Sodium Silicate	150	70	A	A	A	A	A	A	A	A	A	A	A	A	A	X	X	A	A	T	S	V	B	E	
Sodium Sulfate	150	70	A	A	A	A	A	A	A	A	A	A	A	A	A	B	X	A	A	T	S	V	B	E	
Sodium Sulfide	150	70	A	A	A	A	A	A	A	A	A	A	A	A	B	A	X	X	X	A	T		V	B	E
Sodium Sulfite	150	70	A	A	A	A	A	A	A	B	A	A	A	A	I	A	I	I	I	T	S	V	B		
Sodium Sulphydrate	100	70	A	I	X	X	X	X	A	X	A	I	I	I	I	I	I	I	I	T			B		
Sodium Thiosulfate	150	70	A	A	A	A	A	A	A	A	A	A	A	A	A	I	X	A	A	T	S	V	B	E	
Stannic Chloride	150	70	A	A	A	A	A	I	A	A	A	A	A	B	X	X	X	X	X	A	T		B	E	
Stannic Sulfide	150	70	A	A	A	A	A	I	A	A	A	I	A	I	I	I	I	I	I	T			B	E	
Stannous Chloride	150	70	A	A	A	A	A	I	A	B	A	I	A	I	X	A	X	X	X	T			B		
Stannous Sulfide	150	70	A	A	A	A	A	I	A	A	A	I	A	I	I	I	I	I	I	T			B	E	
Stearic Acid	100	70	A	X	B	X	X	I	A	B	A	A	A	A	A	B	A	A	A	T		V	B		
Stoddards Solvent	100	70	A	X	X	X	X	A	A	X	A	I	I	I	I	A	A	I	X	A	T		V	B	
Styrene	100	70	B	X	X	X	X	A	X	X	I	I	I	I	A	A	I	I	I	T		V			
Sulfamic Acid (>10%)	100	70	X	I	A	B	B	I	B	I	I	I	I	I	I	I	I	I	I	T		V			
Sulfonic Acid	100	70	B	X	X	X	X	X	X	I	B	I	B	I	I	I	I	I	I	T		V			
Sulfur Dioxide (Liquid)	100	70	B	I	B	B	I	X	I	I	X	X	X	X	I	A	I	I	I	T					
Sulfuric Acid 25%	150	70	A	I	A	B	B	I	X	A	A	A	A	I	I	X	X	I	I	T		V		E	
Sulfuric Acid 93%	100	70	X	I	X	B	X	B	X	B	A	I	I	I	I	X	X	I	I	T		V			
Sulfuric Acid 93-98%	100	70	X	I	X	X	X	B	X	X	I	I	I	I	I	X	X	I	I	T		V			
Sulfuric Acid Fuming	100	70	X	I	X	X	X	X	X	X	X	X	X	X	I	X	X	I	I	T					
Sulfurous Acid 10%	150	70	A	I	A	A	A	I	X	A	A	B	B	A	I	X	X	I	I	T				E	
Sulfurous Acid 10-75%	100	70	A	I	A	A	A	I	X	A	A	X	X	X	I	X	X	I	I	T				E	
Sulphonate	100	70	I	I	X	X	X	X	A	X	X	I	I	I	I	I	I	I	I	T			B		
Tall Oil	100	70	A	X	X	X	X	A	A	X	I	I	I	I	I	A	X	X	I	T		V	B		
Tallow	150	70	A	X	X	X	X	I	A	X	I	I	I	I	A	A	I	A	A	T	S		B		
Tannic Acid	150	70	A	A	A	A	A	I	B	X	I	B	B	A	A	A	X	I	X	A	T		V	B	
Tar			CALL																						
Tartaric Acid	150	70	A	A	A	A	A	I	A	A	A	A	A	A	A	I	A	A	A	T			B	E	

BUCHANAN RUBBER CHEMICAL RESISTANCE GUIDE

Chemical	HOSE TEMPERATURE (F)	PVC TEMPERATURE (F)	HOSE AND SHEET RUBBER									THERMOPLASTIC HOSE			COUPLINGS					GASKETS					
			UHMWPE	SBR	BUTYL	HYPALON	NATURAL	VITON	NITRILE	EPDM	XLPE	TPU	PVC	TPR	304SS	316SS	ALUMINUM	BRASS	NYLON	POLYPROPYLENE	TEFLON	SILICONE	VITON	BUNA	EPDM
Tergitol	100	70	X	I	I	I	I	I	I	I	I	I	I	I	I	I	I	I	I	T					
Tertiary Butyl Alcohol	100	70	A	A	A	A	A	B	A	A	A	B	B	I	I	I	I	I	I	T			B	E	
Tetrachlorobenzene	100	70	B	X	X	X	X	B	X	X	B	I	X	I	I	I	I	I	I	T					
Tetrachloroethane	100	70	A	X	X	X	X	A	X	X	X	I	X	X	I	A	X	X	I	I	T	V			
Tetrachloroethylene	100	70	A	X	X	X	X	A	X	X	A	I	X	X	I	A	B	X	I	I	T	V			
Tetrachloromethane	100	70	A	X	X	X	X	A	X	X	X	I	X	X	I	A	I	I	I	I	T	V			
Tetrachloronaphthalene	100	70	B	I	X	X	X	B	X	X	X	I	X	X	I	I	I	I	I	T					
Tetrachloronaphthalene	100	70	B	I	X	X	X	B	X	X	X	I	X	X	I	I	I	I	I	T					
Tetradecanol	100	70	A	I	A	A	A	B	A	A	A	I	I	I	I	I	I	I	I	T			B	E	
Tetraethylene Glycol	150	70	A	A	A	A	A	A	A	A	A	I	B	I	I	I	I	I	I	T	V	B	E		
Tetraethylene Lead	100	70	X	I	X	X	X	A	X	X	X	I	I	I	I	I	I	I	I	T	V				
Tetrahydrofuran	100	70	B	I	X	X	X	X	X	X	B	X	X	X	A	A	B	X	A	X	T				
THF	100	70	B	I	X	X	X	X	X	X	B	I	X	X	I	A	B	X	I	I	T				
Thionyl Chloride	100	70	X	X	I	I	I	I	I	I	I	I	I	I	X	X	X	I	I	T					
Tin Chloride	100	70	A	A	A	A	A	I	A	A	A	B	B	B	I	X	X	X	I	I	T	V	B	E	
Tin Tetrachloride	150	70	B	A	A	A	A	I	A	A	A	B	B	B	I	X	X	X	I	I	T		B	E	
Titanium Tetrachloride	100	70	B	X	X	X	X	A	B	X	A	I	I	I	I	B	X	X	I	I	T	V			
Toluene	100	70	A	I	X	X	X	A	X	X	B	X	X	X	I	A	A	A	A	X	T	V			
Toluidine	100	70	X	I	I	I	I	I	I	I	I	I	X	I	I	I	I	I	I	I	T				
Toluol	100	70	A	I	X	X	X	A	X	X	A	X	X	X	I	A	A	A	I	I	T	V			
Transformer Oil	100	70	X	I	I	I	I	I	I	I	I	I	I	I	I	A	I	I	I	I	T				
Transmission Oil "A"	150	70	B	I	X	X	X	A	A	X	I	A	B	I	I	A	A	A	I	I	T	V	B		
Tributoxy Ethylsulphate	100	70	I	I	A	X	X	A	X	A	X	I	I	I	I	I	I	I	I	I	T	V		E	
Tributyl Amine	100	70	A	A	A	X	B	I	B	I	A	I	I	I	I	I	I	I	I	I	T				
Tributyl Phosphate	100	70	A	X	A	X	X	X	X	X	A	X	X	X	I	A	I	X	I	I	T				
Trichlorobenzene	100	70	B	X	X	X	X	B	X	X	B	X	X	X	I	I	A	I	I	I	T				
Trichloroethane	100	70	A	X	X	X	X	A	X	X	X	I	X	X	I	A	I	I	I	I	T	V			
Trichloroethylene	100	70	X	X	X	X	X	A	X	X	X	I	I	I	I	A	I	I	A	X	T	V			
Trichloropropane	100	70	A	X	X	X	X	A	X	X	A	I	I	X	I	A	X	I	I	I	T	V			
Tricresylphosphate	100	70	A	I	A	X	X	A	X	A	A	I	I	I	I	I	A	X	I	I	T	V		E	
Tridecanol	100	70	A	I	A	A	A	B	A	A	A	I	I	I	I	I	I	I	I	I	T		B	E	
Triethanolamine	100	70	A	I	A	X	B	X	B	A	A	B	B	I	I	A	I	X	A	X	T		B	E	
Triethylamine	100	70	A	A	A	X	B	I	B	I	A	I	I	I	I	A	I	I	A	X	T	V	B		
Triethylene Glycol	150	70	A	A	A	A	A	I	A	I	A	I	B	B	I	A	A	I	I	I	T		B		
Trifluralin (Trefalin)	100	70	A	I	X	X	X	A	X	X	A	I	I	I	I	I	I	I	I	I	T	V			
Triphenyl Phosphate	100	70	A	X	A	X	X	I	X	I	A	B	X	I	I	A	I	I	I	I	T				
Tripolyphosphate	100	70	X	I	I	I	I	I	I	I	I	I	I	I	I	I	I	I	I	I	T				
Trisodium Phosphate	150	70	A	A	A	A	A	A	A	A	A	B	B	A	I	A	X	I	A	A	T	S	V	B	E
Turpentine	100	70	A	X	X	X	X	A	A	X	A	B	B	X	A	A	A	A	A	A	T	V	B		
Undecanol	100	70	B	A	A	A	A	B	A	A	A	I	A	I	I	I	I	I	I	I	T		B	E	
Urea	100	70	A	B	A	I	I	I	X	I	A	A	A	A	I	A	B	I	A	A	T	V	B		
V.M. & P. Naptha	100	70	A	I	X	X	X	A	A	X	A	I	B	I	I	I	I	I	I	I	T	S	V	B	
Vinyl Acetate	100	70	A	X	A	B	X	X	X	X	A	I	X	X	I	A	I	X	I	I	T	V			
Vinyl Benzene	100	70	A	X	X	X	X	A	X	X	A	I	X	X	I	A	I	I	I	I	T	V			

BUCHANAN RUBBER CHEMICAL RESISTANCE GUIDE

Chemical	HOSE TEMPERATURE (F)	PVC TEMPERATURE (F)	HOSE AND SHEET RUBBER									THERMOPLASTIC HOSE			COUPLINGS					GASKETS						
			UHMWPE	SBR	BUTYL	HYPALON	NATURAL	VITON	NITRILE	EPDM	XLPE	TPU	PVC	TPR	304SS	316SS	ALUMINIUM	BRASS	NYLON	POLYPROPYLENE	TEFLON	SILICONE	VITON	BUNA	EPDM	
Vinyl Chloride			N/R																							
Vinyl Ether			N/R																							
Vinyl Toluene	100	70	A	X	X	X	X	A	X	X	A	I	I	I	I	I	I	I	I	T		V				
Vinyl Trichloride	100	70	A	X	X	X	X	A	X	X	A	I	I	I	I	A	I	I	I	I	T		V			
Water	180	70	A	I	A	A	A	A	A	A	A	A	A	A	I	A	A	A	A	T	S	V	B	E		
Wax	100	70	A	I	X	X	X	X	A	X	X	I	I	I	I	A	I	I	I	T		V	B			
White Oil	100	70	A	X	X	X	X	I	A	X	I	I	I	I	I	I	I	I	I	T		V	B			
Wood Alcohol	100	70	A	I	A	A	A	X	A	A	A	B	B	A	I	A	I	I	I	T	S		B	E		
Xylene (Xylol)	100	70	X	X	X	X	X	A	X	X	A	X	X	X	I	A	I	I	A	X	T		V			
Xylidine	100	70	B	X	X	X	X	X	X	X	B	I	X	I	I	B	A	I	I	T						
Zinc Carbonate	150	70	A	A	A	A	A	A	A	A	A	I	A	B	I	B	B	X	I	I	T		V	B	E	
Zinc Chloride	150	70	A	A	A	A	A	A	A	A	A	A	A	B	X	A	X	X	A	A	T	S	V	B	E	
Zinc Chromate	150	70	A	B	A	X	I	I	I	X	B	A	A	I	I	I	I	I	I	T						
Zinc Phosphate	100	70	A	I	X	X	X	X	A	A	X	I	I	I	I	I	I	I	I	T	S		B	E		
Zinc Sulfate	150	70	A	A	A	A	A	A	A	A	A	A	A	B	A	A	X	X	X	A	T	S		B	E	

AZTEC SLURRY HOSE



- Application** : Primarily designed for handling abrasive slurries in mines and quarries. Can also be used for dry material handling of sand, gravel, grain, slag, and other such materials. External re-usable bolt on flanges allow for ease of installation, and uninterrupted free flow.
- Cover** : Thick black corrugated abrasion and weather resistant synthetic blend. Specially compounded to stand up to heavy abuse in mines and quarries.
- Reinforcement** : Multiple layers of high tensile synthetic cords enveloping an extra heavy duty wire helix.
- Tube** : Ultra high quality blended rubber tube; 3/8" thick red tube.
- Temperature** : -40C to +80C(-40F to +180F)

Nom. I.D	Nom. O.D	Vacuum (Hg)	Bend Radius	PSI	Weight (lbs)	Std Pack Qty	Part #
3"	4.49"	30"	14.00"	150	4.55	100'	AZ-300
4"	5.27"	30"	18.00"	150	5.23	100'	AZ-400
5"	6.45"	30"	24.00"	150	6.55	100'	AZ-500
6"	7.48"	30"	28.00"	150	8.9	100'	AZ-600
8"	9.53"	30"	48.00"	150	13.24	60'	AZ-800
10"	11.49"	30"	60.00"	150	15.07	40'	AZ-1000
12"	13.74"	30"	90.00"	150	21.77	20'	AZ-1200

Recommended Couplings : Aluminum or Ductile Split Flange
Cut Lengths : Plus 10%
Standard Lengths : 3" to 6" - 100' -- 8" -60' -- 10" and 12" - 20'

SPLIT FLANGE ALUMINUM FOR MATERIAL HANDLING HOSE

Size	Weight (lbs)	Std Pack Qty	Part #
2"	3.00	10	SFL-200-A
3"	4.40	10	SFL-300-A
4"	6.60	5	SFL-400-A
5"	7.50	4	SFL-500-A
6"	8.80	3	SFL-600-A
8"	13.30	2	SFL-800-A
10"	25.40	2	SFL-1000-A
12"	30.90	1	SFL-1200-A
14"	36.00	1	SFL-1400-A



Air and General Purpose Hose

SPLIT FLANGE DUCTILE FOR MATERIAL HANDLING HOSE

Water Suction and Discharge Hose



Size	Weight (lbs)	Std Pack Qty	Part #
4"	16.89	1	SFL-400-DP
6"	22.00	1	SFL-600-DP

Petroleum, Steam and Chemical Hose

Rubber Material Handling Hose

GASKET FOR SPLIT FLANGE

Plastic Material Handling Hose



Size	Weight (lbs)	Std Pack Qty	Part #
3"	0.26	1	SFLG-300
4"	0.35	1	SFLG-400
5"	0.40	1	SFLG-500
6"	0.44	1	SFLG-600
8"	0.55	1	SFLG-800
10"	0.69	1	SFLG-1000

Food Hose

Ducting

Auto Truck and Marine Hose

Fire Hose

GUNITE

Welding and Other Hose



Cam and Groove

Nipples, Menders and Shank Fittings

Application : For conveying dry sand and cement in guniting operations. Also suitable for general material handling applications where a thick cut and abrasion resistant tube is required.

Clamps

Cover Reinforcement Tube : Tan abrasion and weather resistant synthetic rubber.
: Multiple layers of synthetic textile cords with embedded static wire.
: Tan 1/4" thick natural rubber for maximum cut and abrasion resistance.

High Pressure Fittings

Temperature : -32C to +80C (-25F to +180F)

Mine Fittings

	Nom. I.D	Nom. O.D	PSI	Weight (lbs)	Std Pack Qty	Part #
Air Fittings	1-1/4"	2.13"	150	1.20	100'	GTT-125
Valves	1-1/2"	2.44"	150	1.55	100'	GTT-150
	1-3/4"	2.75"	150	1.81	100'	GTT-175
	2"	2.87"	150	1.89	100'	GTT-200

Sandblast

Cut Lengths : POA

Standard Lengths : 50/100

Fire Fittings

Product Information : Longer lengths available, check for price and availability

Recommended Couplings : Proprietary gunite fittings

Pipe Fittings

Sheet Rubber

Index and Technical Information

BULKMASTER HARDWALL



- Application** : Dry bulk suction and discharge including limestone, ground silica, chalk, dry cement, fertilizer etc. May also be used for wet abrasive applications.
- Cover** : Black abrasion and weather resistant synthetic rubber.
- Reinforcement** : A high tensile steel helix embedded between layers of textile cords.
- Tube** : Black abrasion resistant natural rubber 3/16" thick.
- Temperature** : -30C to +80C(-25F to +180F)

Nom. I.D	Nom. O.D	Vacuum (Hg)	Bend Radius	PSI	Weight (lbs)	Std Pack Qty	Part #
3"	3.70"	29"	27.00"	150	2.40	100'	BHB-300
4"	4.80"	29"	36.00"	100	4.41	100'	BHB-400
4"	5.01"	29"	38.00"	100	4.60	100'	BHB-400-313
5"	5.79"	29"	40.00"	100	5.36	100'	BHB-500

Cut Lengths : Plus 10%
Standard Lengths : 100'

BULKMASTER SOFTWALL



- Application** : Dry bulk discharge including limestone, ground silica, chalk, dry cement, fertilizer etc. May also be used for wet abrasive applications.
- Cover** : Black abrasion and weather resistant synthetic rubber. Green stripe on 1/4" thick tube.
- Reinforcement** : Multiple layers of high tensile synthetic cords.
- Tube** : Black abrasion resistant natural rubber in 1/8", 3/16" and 1/4"
- Temperature** : -30C to +80C(-25F to +180F)

Nom. I.D	Nom. O.D	PSI	Weight (lbs)	Std Pack Qty	Part #
3"	3.62"	75	1.78	100'	BSB-300-187
4"	4.49"	75	1.50	100'	BSB-400-125
4"	4.64"	75	2.15	100'	BSB-400-187
4"	4.72"	75	2.60	100'	BSB-400-250
4"	5.00"	75	3.40	100'	BSB-400-375
4-1/2"	5.00"	75	1.80	100'	BSB-450-125
5"	5.51"	75	2.10	100'	BSB-500-125
5"	5.63"	75	2.52	100'	BSB-500-187
5"	5.79"	75	3.50	100'	BSB-500-250
5"	5.93"	75	3.00	100'	BSB-500-313
6"	6.65"	75	3.30	100'	BSB-600-187
6"	6.81"	75	3.84	100'	BSB-600-250

Cut Lengths : Plus 10%
Standard Lengths : 100'

Air and General Purpose Hose

Water Suction and Discharge Hose

Petroleum, Steam and Chemical Hose

Rubber Material Handling Hose

Plastic Material Handling Hose

Food Hose

Ducting

Auto Truck and Marine Hose

Fire Hose

Welding and Other Hose

Cam and Groove

Nipples Menders and Shank Fittings

Clamps

High Pressure Fittings

Mine Fittings

Air Fittings

Valves

Sandblast

Fire Fittings

Pipe Fittings

Sheet Rubber

Index and Technical Information

Air and General Purpose Hose

Water Suction and Discharge Hose

Petroleum, Steam and Chemical Hose

Rubber Material Handling Hose

Plastic Material Handling Hose

Food Hose

Ducting

Auto Truck and Marine Hose

Fire Hose

Welding and Other Hose

Cam and Groove

Nipples, Menders and Shank Fittings

Clamps

High Pressure Fittings

Mine Fittings

Air Fittings

Valves

Sandblast

Fire Fittings

Pipe Fittings

Sheet Rubber

Index and Technical Information

SANDBLAST



Cover : Black static conductive synthetic rubber.
Reinforcement : Two (SBB) or Four (SBB4) layers of synthetic textile cords.
Tube : Thick black static conductive abrasion resistant natural rubber.
Temperature : -35C to +80C(-30F to +180F)

	Nom. I.D	Nom. O.D	PSI	Weight (lbs)	Std Pack Qty	Part #
Rubber Material Handling Hose	1/2"	1.20"	150	0.47	50'	SBB-050-50L
	1/2"	1.20"	150	0.47	100'	SBB-050-100L
Plastic Material Handling Hose	1/2"	1.14"	150	0.44	50'	SBB-050-50S
	1/2"	1.14"	150	0.44	100'	SBB-050-100S
Food Hose	1/2"	1.08"	150	0.37	50'	SBB-050-50U
	1/2"	1.08"	150	0.37	100'	SBB-050-100U
Ducting	3/4"	1.50"	150	0.65	50'	SBB-075-50
Auto Truck and Marine Hose	3/4"	1.50"	150	0.68	100'	SBB-075-100
	1"	1.89"	150	1.00	50'	SBB-100-50S
Fire Hose	1"	1.89"	150	1.00	100'	SBB-100-100S
	1"	1.50"	150	0.51	50'	SBB-100-50U
Welding and Other Hose	1"	1.50"	150	0.51	100'	SBB-100-100U
Cam and Groove	1-1/4"	2.16"	150	1.22	50'	SBB-125-50S
	1-1/4"	2.16"	150	1.22	100'	SBB-125-100S
Nipples, Menders and Shank Fittings	1-1/4"	1.89"	150	0.79	50'	SBB-125-50U
	1-1/4"	1.89"	150	0.79	100'	SBB-125-100U
	1-1/2"	2.36"	150	1.36	50'	SBB-150-50
	1-1/2"	2.36"	150	1.36	100'	SBB-150-100
Clamps	2"	2.87"	150	1.70	50'	SBB-200-50
High Pressure Fittings	2"	2.87"	150	1.70	100'	SBB-200-100
	2-1/2"	3.42"	150	2.21	100'	SBB-250
Mine Fittings	3"	3.98"	150	2.57	100'	SBB-300
Air Fittings	1"	1.88"	150	0.98	100'	SBB4-100-100S
	1-1/4"	2.16"	150	1.26	100'	SBB4-125-100S
Valves	1-1/2"	2.38"	150	1.33	100'	SBB4-150-100

Cut Lengths : Plus 10%

Standard Lengths : 50'/100'

Product Information : Longer lengths available up to 400'. Surcharges may apply

TAN BULKMASTER



- Application** : Suction and discharge of non-oily, wet and dry abrasive materials such as corn, flour, sand, limestone powder, plastic pellets and sugar.
- Cover** : Tan non-marking, weather resistant EPDM, corrugated for flexibility.
- Reinforcement** : A high tensile steel helix embedded between layers of textile cords.
- Tube** : Tan smooth abrasion resistant, 3/16" FDA approved natural rubber.
- Temperature** : -32C to +80C (-25F to +180F)

Nom. I.D	Nom. O.D	Vacuum (Hg)	Bend Radius	PSI	Weight (lbs)	Std Pack Qty	Part #
2"	2.72"	29"	7.00"	65	1.54	100'	TBT-200
2-1/2"	3.19"	29"	8.00"	65	1.84	100'	TBT-250
3"	3.70"	29"	10.00"	65	2.17	100'	TBT-300
4"	4.76"	29"	14.00"	50	3.33	100'	TBT-400
5"	5.79"	29"	20.00"	50	3.94	100'	TBT-500
6"	6.77"	29"	24.00"	50	5.25	100'	TBT-600
8"	8.97"	29"	30.00"	50	8.72	100'	TBT-800

- Cut Lengths** : Plus 10%
- Standard Lengths** : 100'
- Recommended Couplings** : Cam and groove

CONCRETE PLACEMENT



- Application** : Conducting wet cement, plaster, grout, and concrete at high pressure.
- Cover** : Black cut and abrasion resistant synthetic rubber.
- Reinforcement** : Multiple layers of high tensile synthetic cords.
- Tube** : Black abrasion resistant natural rubber.
- Temperature** : -35C to +80C (-30F to +180F)

Nom. I.D	Nom. O.D	PSI	Weight (lbs)	Std Pack Qty	Part #
1-1/2"	2.28"	800	1.13	100'	CPB-150
2"	2.83"	800	1.56	100'	CPB-200
2-1/2"	3.38"	800	2.35	100'	CPB-250
3"	3.90"	600	2.35	100'	CPB-300
4"	4.92"	550	3.81	100'	CPB-400

- Cut Lengths** : Plus 10%
- Standard Lengths** : 50'/100'
- Recommended Couplings** : Swaged on concrete fittings

Air and General Purpose Hose

Water Suction and Discharge Hose

Petroleum, Steam and Chemical Hose

Rubber Material Handling Hose

Plastic Material Handling Hose

Food Hose

Ducting

Auto Truck and Marine Hose

Fire Hose

Welding and Other Hose

Cam and Groove

Nipples, Menders and Shank Fittings

Clamps

High Pressure Fittings

Mine Fittings

Air Fittings

Valves

Sandblast

Fire Fittings

Pipe Fittings

Sheet Rubber

Index and Technical Information

Air and General Purpose Hose

CONCRETE PLACEMENT WIRE REINFORCED



Water Suction and Discharge Hose

- Application** : Conducting wet cement, plaster, grout, and concrete at high pressure.
Cover : Black cut and abrasion resistant synthetic rubber.
Reinforcement : 4 plies of steel cables.
Tube : Black abrasion resistant natural rubber.
Temperature : -35C to +80C(-30F to +180F)

Petroleum, Steam and Chemical Hose

Rubber Material Handling Hose

	Nom. I.D	Nom. O.D	PSI	Weight (lbs)	Std Pack Qty	Part #
	2-1/2"	3.35"	1000	2.59	100'	CPW-250
	3"	3.94"	1000	3.31	100'	CPW-300
	4"	5.01"	800	4.55	100'	CPW-400
	5"	6.00"	700	6.26	100'	CPW-500

Plastic Material Handling Hose

Food Hose

- Cut Lengths** : Plus 10%
Standard Lengths : 50'/100'
Recommended Couplings : Swaged on concrete fittings

Ducting

Auto Truck and Marine Hose

INDUSTRIAL VACUUM HEAVY DUTY



Fire Hose

Welding and Other Hose

- Application** : For handling abrasive dust from wood, metal, rock, marble and concrete grinding machines under vacuum.
Cover : Black abrasion resistant rubber, corrugated for flexibility.
Reinforcement : A high tensile steel helix embedded between layers of textile cords.
Tube : 1/4" or 1/8" red Pure Gum abrasion resistant rubber standard.
Temperature : -30C to +80C(-25F to +180F)

Cam and Groove

Nipples, Menders and Shank Fittings

	Nom. I.D	Nom. O.D	Vacuum (Hg)	Bend Radius	PSI	Weight (lbs)	Std Pack Qty	Part #
Clamps	3"	3.58"	28"	15.00"	90	1.61	100'	IVB-300-125RPG
	4"	4.61"	28"	20.00"	90	2.35	100'	IVB-400-125RPG
High Pressure Fittings	4"	4.88"	28"	20.00"	90	3.11	100'	IVB-400-250RPG
	6"	6.65"	28"	24.00"	60	4.08	100'	IVB-600-125RPG
Mine Fittings	6"	6.95"	28"	24.00"	60	5.91	100'	IVB-600-250RPG
	8"	8.78"	28"	30.00"	50	7.48	100'	IVB-800-125RPG
Air Fittings	8"	9.01"	28"	30.00"	50	10.23	100'	IVB-800-250RPG
Valves								
Sandblast								

- Cut Lengths** : Plus 10%
Standard Lengths : 100'
Recommended Couplings : Cam and groove

Clamps

High Pressure Fittings

Mine Fittings

Air Fittings

Valves

Sandblast

Fire Fittings

Pipe Fittings

Sheet Rubber

Index and Technical Information

INDUSTRIAL VACUUM



- Application** : For handling abrasive dust from wood, metal, rock, marble and concrete grinding machines under vacuum.
- Cover** : Black abrasion resistant rubber, corrugated for flexibility.
- Reinforcement** : A high tensile steel helix embedded between layers of textile cords.
- Tube** : 1/16 black abrasion resistant synthetic rubber standard. 1/8 thick tube stocked in 4", other sizes available on request.
- Temperature** : -30C to +80C(-25F to +180F)

Nom. I.D	Nom. O.D	Vacuum (Hg)	Bend Radius	PSI	Weight (lbs)	Std Pack Qty	Part #
1"	1.38"	24"	4.00"	40	0.39	100'	IVB-100
1-1/4"	1.65"	24"	5.00"	40	0.48	100'	IVB-125
1-1/2"	1.97"	24"	6.00"	40	0.60	100'	IVB-150
2"	2.40"	20"	7.00"	40	0.70	100'	IVB-200
2-1/2"	2.95"	18"	10.00"	40	1.03	100'	IVB-250
3"	3.42"	14"	12.00"	40	1.20	100'	IVB-300
3-1/2"	3.90"	12"	14.00"	40	1.29	100'	IVB-350
4"	4.45"	12"	15.00"	40	1.98	100'	IVB-400
4-1/2"	4.96"	10"	18.00"	40	2.05	100'	IVB-450
5"	5.51"	10"	22.00"	40	2.87	100'	IVB-500
6"	6.53"	10"	24.00"	40	3.84	100'	IVB-600

Cut Lengths : Plus 10%

Standard Lengths : 100'

Product Information : Longer lengths available, check for price and availability

Recommended Couplings : Cam and groove

Air and General Purpose Hose

Water Suction and Discharge Hose

Petroleum, Steam and Chemical Hose

Rubber Material Handling Hose

Plastic Material Handling Hose

Food Hose

Ducting

Auto Truck and Marine Hose

Fire Hose

Welding and Other Hose

Cam and Groove

Nipples Menders and Shank Fittings

Clamps

High Pressure Fittings

Mine Fittings

Air Fittings

Valves

Sandblast

Fire Fittings

Pipe Fittings

Sheet Rubber

Index and Technical Information

Safety Information : PVC Suction and pressure ratings are based on 20C (68F). reduce ratings by 50% at maximum working temperature.

ARI SUCTION



Application : Used in a variety of material handling application where a good resistance to abrasion is required, such as transfer of sands, plastic pellets, gravel, wood chips, slurries and fly ash. Tube and cover is a specially formulated technical alloy that makes this hose antistatic.

Cover : Vinyl modified nitrile
Reinforcement : Anti shock rigid pvc helix
Tube : An alloy of polyurethane and pvc
Temperature : -30C to +65C(-22F to +150F)

Nom. I.D	Nom. O.D	Vacuum (Hg)	Bend Radius	PSI	Weight (lbs)	Std Pack Qty	Part #
2"	2.50"	26"	5.50"	70	0.50	100'	ARI-200
2-1/2"	3.00"	26"	6.00"	70	0.88	100'	ARI-250
3"	3.58"	26"	7.00"	60	1.10	100'	ARI-300
4"	4.78"	26"	10.00"	60	2.15	100'	ARI-400
5"	5.77"	26"	16.00"	60	2.62	100'	ARI-500
6"	6.82"	26"	20.00"	60	3.08	100'	ARI-600
8"	9.00"	26"	30.00"	45	5.50	60'	ARI-800

Cut Lengths : Plus 10%
Standard Lengths : 100'
Recommended Couplings : Cam and groove

Air and General Purpose Hose

Water Suction and Discharge Hose

Petroleum, Steam and Chemical Hose

Rubber Material Handling Hose

Plastic Material Handling Hose

Food Hose

Ducting

Auto Truck and Marine Hose

Fire Hose

Welding and Other Hose

Cam and Groove

Nipples Menders and Shank Fittings

Clamps

High Pressure Fittings

Mine Fittings

Air Fittings

Valves

Sandblast

Fire Fittings

Pipe Fittings

Sheet Rubber

Index and Technical Information

Air and General Purpose Hose

Water Suction and Discharge Hose

Petroleum, Steam and Chemical Hose

Rubber Material Handling Hose

Plastic Material Handling Hose

Food Hose

Ducting

Auto Truck and Marine Hose

Fire Hose

Welding and Other Hose

Cam and Groove

Nipples, Menders and Shank Fittings

Clamps

High Pressure Fittings

Mine Fittings

Air Fittings

Valves

Sandblast

Fire Fittings

Pipe Fittings

Sheet Rubber

Index and Technical Information

B - FLEX (FOOD GRADE)

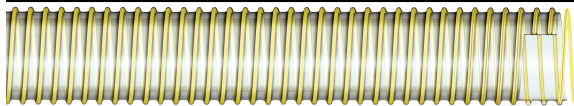

- Application** : Conveying of dry powders, grains and plastic pellets where viewing the product is important. Clear wall allows easy monitoring of product. Not recommended for handling liquids
- Cover** : Corrugated clear PVC.
- Reinforcement** : Cream coloured rigid PVC helix
- Tube** : Smooth clear PVC
- Temperature** : -10C to +60C(15F to +140F)

	Nom. I.D	Nom. O.D	Vacuum (Hg)	Bend Radius	PSI	Weight (lbs)	Std Pack Qty	Part #
	1"	1.20"	20"	1.50"	45	0.14	100'	BFL-100
	1-1/4"	1.57"	20"	2.00"	45	0.20	100'	BFL-125
	1-1/2"	1.85"	20"	3.00"	45	0.25	100'	BFL-150
	2"	2.35"	20"	4.00"	40	0.39	100'	BFL-200
	2-1/2"	2.88"	20"	5.00"	40	0.63	100'	BFL-250
	3"	3.38"	20"	6.00"	40	0.75	100'	BFL-300
	39mm	1.88"	20"	3.00"	45	0.26	100'	BFL-39-MM
	45mm	2.10"	20"	4.00"	45	0.32	100'	BFL-45-MM
	57mm	2.60"	20"	5.00"	40	0.53	100'	BFL-57-MM

Cut Lengths : Plus 10%

Standard Lengths : 100'

Recommended Couplings : Cam and groove

B - FLEX (STATIC) (FOOD GRADE)

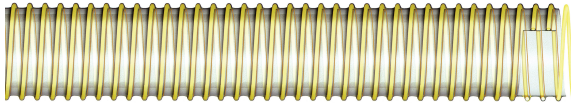

- Application** : Conveying of dry powders, grains and plastic pellets where static electricity is a problem. Clear wall allows easy monitoring of product. Not recommended for handling liquids
- Cover** : Corrugated clear PVC.
- Reinforcement** : Cream coloured rigid PVC helix Static style with integral static wire.
- Tube** : Smooth clear PVC
- Temperature** : -10C to +60C(15F to +140F)

Nom. I.D	Nom. O.D	Vacuum (Hg)	Bend Radius	PSI	Weight (lbs)	Std Pack Qty	Part #
1-1/2"	1.85"	20"	1.50"	45	0.26	100'	BFLST-150
2"	2.35"	20"	4.00"	40	0.40	100'	BFLST-200
2-1/2"	2.88"	20"	5.00"	40	0.65	100'	BFLST-250
3"	3.38"	20"	6.00"	40	0.77	100'	BFLST-300
39mm	1.88"	20"	3.00"	45	0.27	100'	BFLST-39-MM
45mm	2.10"	20"	4.00"	45	0.33	100'	BFLST-45-MM
57mm	2.60"	20"	5.00"	40	0.54	100'	BFLST-57-MM

Cut Lengths : Plus 10%

Standard Lengths : 100'

Recommended Couplings : Cam and groove

Air and General Purpose Hose

Water Suction and Discharge Hose

Petroleum, Steam and Chemical Hose

Rubber Material Handling Hose

Plastic Material Handling Hose

Food Hose

Ducting

Auto Truck and Marine Hose

Fire Hose

Welding and Other Hose

Cam and Groove

Nipples, Menders and Shank Fittings

Clamps

High Pressure Fittings

Mine Fittings

Air Fittings

Valves

Sandblast

Fire Fittings

Pipe Fittings

Sheet Rubber

Index and Technical Information

Air and General Purpose Hose

Water Suction and Discharge Hose

Petroleum, Steam and Chemical Hose

Rubber Material Handling Hose

Plastic Material Handling Hose

Food Hose

Ducting

Auto Truck and Marine Hose

Fire Hose

Welding and Other Hose

Cam and Groove

Nipples, Menders and Shank Fittings

Clamps

High Pressure Fittings

Mine Fittings

Air Fittings

Valves

Sandblast

Fire Fittings

Pipe Fittings

Sheet Rubber

Index and Technical Information

GREY PVC VACUUM

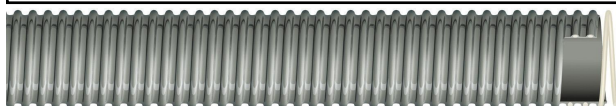

- Application** : An economical hose for suction of air, fumes, sawdust, and powders in light duty applications.
- Cover** : Grey corrugated PVC for maximum flexibility.
- Reinforcement** : Rigid PVC helix.
- Tube** : Smooth grey PVC.
- Temperature** : -10C to +65C(15F to +150F)

	Nom. I.D	Nom. O.D	Vacuum (Hg)	Bend Radius	PSI	Weight (lbs)	Std Pack Qty	Part #
	3/4"	1.02"	20"	1.00"	30	0.08	100'	GRVAC-075
	1"	1.28"	20"	1.50"	30	0.12	100'	GRVAC-100
	1-1/4"	1.54"	20"	2.00"	30	0.20	100'	GRVAC-125
	1-1/2"	1.83"	20"	2.50"	25	0.24	100'	GRVAC-150
	2"	2.33"	15"	3.00"	25	0.38	100'	GRVAC-200
	2-1/2"	2.85"	15"	4.00"	20	0.45	100'	GRVAC-250
	3"	3.35"	15"	5.00"	15	0.55	100'	GRVAC-300
	4"	4.50"	10"	6.00"	15	0.85	100'	GRVAC-400
	5"	5.50"	10"	8.00"	12	1.10	100'	GRVAC-500
	6"	6.50"	10"	9.00"	12	1.36	100'	GRVAC-600
	8"	8.53"	10"	10.00"	10	1.85	100'	GRVAC-800

Product Information : 8" size stocked with clear wall instead of grey.
Cut Lengths : Plus 10%
Standard Lengths : 100'

NEPTUNE PVC SUCTION (FOOD GRADE)



- Application** : Suction and discharge of liquids and powders where moderate abrasion is a factor.
Cover : Corrugated clear PVC.
Reinforcement : Clear or cream coloured rigid PVC helix
Tube : Smooth clear PVC.
Temperature : -10C to +65C(15F to +150F)

Nom. I.D	Nom. O.D	Vacuum (Hg)	Bend Radius	PSI	Weight (lbs)	Std Pack Qty	Part #
1-1/2"	1.80"	28"	4.50"	60	0.55	100'	NEP-150
2"	2.37"	28"	5.00"	60	0.68	100'	NEP-200
2-1/2"	2.90"	26"	6.00"	55	0.95	100'	NEP-250
3"	3.45"	26"	9.00"	50	1.14	100'	NEP-300
4"	4.53"	26"	12.00"	40	1.80	100'	NEP-400
5"	5.60"	24"	16.00"	30	2.35	100'	NEP-500
57mm	2.65"	26"	6.00"	60	0.83	100'	NEP-57-MM
6"	6.70"	24"	20.00"	30	3.30	100'	NEP-600
8"	8.80"	24"	28.00"	20	5.75	60'	NEP-800

Cut Lengths : Plus 10%

Standard Lengths : 2" - 6" - 100'

Recommended Couplings : Cam and groove

Air and General Purpose Hose

Water Suction and Discharge Hose

Petroleum, Steam and Chemical Hose

Rubber Material Handling Hose

Plastic Material Handling Hose

Food Hose

Ducting

Auto Truck and Marine Hose

Fire Hose

Welding and Other Hose

Cam and Groove

Nipples, Menders and Shank Fittings

Clamps

High Pressure Fittings

Mine Fittings

Air Fittings

Valves

Sandblast

Fire Fittings

Pipe Fittings

Sheet Rubber

Index and Technical Information

Air and General Purpose Hose

Water Suction and Discharge Hose

Petroleum, Steam and Chemical Hose

Rubber Material Handling Hose

Plastic Material Handling Hose

Food Hose

Ducting

Auto Truck and Marine Hose

Fire Hose

Welding and Other Hose

Cam and Groove

Nipples, Menders and Shank Fittings

Clamps

High Pressure Fittings

Mine Fittings

Air Fittings

Valves

Sandblast

Fire Fittings

Pipe Fittings

Sheet Rubber

Index and Technical Information

NEPTUNE STATIC PVC SUCTION (FOOD GRADE)



- Application** : Suction and discharge of liquids and powders where moderate abrasion is a factor. Built in static wire assists in dissipating static electricity.
- Cover** : Corrugated clear PVC.
- Reinforcement** : Clear or cream coloured rigid PVC helix. Static style with integral static wire.
- Tube** : Smooth clear PVC.
- Temperature** : -10C to +65C(15F to +150F)

	Nom. I.D	Nom. O.D	Vacuum (Hg)	Bend Radius	PSI	Weight (lbs)	Std Pack Qty	Part #
	1-1/2"	1.80"	28"	4.50"	60	0.60	100'	NEPST-150
	2"	2.37"	28"	5.00"	60	0.75	100'	NEPST-200
	2-1/2"	2.90"	26"	6.00"	55	1.00	100'	NEPST-250
	3"	3.43"	26"	9.00"	50	1.20	100'	NEPST-300
	3-1/2"	3.93"	26"	12.00"	45	1.55	100'	NEPST-350
	4"	4.53"	24"	16.00"	45	1.90	100'	NEPST-400
	5"	5.60"	26"	16.00"	40	2.49	100'	NEPST-500
	57mm	2.65"	24"	6.00"	60	0.85	100'	NEPST-57-MM
	6"	6.69"	24"	28.00"	30	3.55	100'	NEPST-600

Cut Lengths : Plus 10%

Standard Lengths : 2" - 6" - 100'

Recommended Couplings : Cam and groove

PU VAC (FOOD QUALITY)



- Application** : Ideal for applications where conventional rubber or PVC hose will wear rapidly, i.e. grain transfer, abrasive powder recovery, leaf collection. Not recommended for handling liquids
- Cover Reinforcement** : Corrugated clear abrasion and weather resistant Polyurethane.
- Tube** : Rigid light grey PVC helix.
- Temperature** : Smooth clear abrasion resistant Polyurethane.
: -30C to +65C(-22F to +150F)

Nom. I.D	Nom. O.D	Vacuum (Hg)	Bend Radius	PSI	Weight (lbs)	Std Pack Qty	Part #
1-1/2"	1.77"	15"	5.00"	45	0.21	100'	PU-150
2"	2.32"	15"	7.00"	40	0.34	100'	PU-200
2-1/2"	2.84"	15"	9.00"	40	0.42	100'	PU-250
3"	3.38"	15"	10.00"	40	0.53	100'	PU-300
4"	4.50"	15"	15.00"	30	0.85	100'	PU-400
5"	5.50"	10"	20.00"	20	1.09	100'	PU-500
6"	6.50"	10"	23.00"	15	1.36	100'	PU-600
60mm	2.70"	15"	8.00"	40	0.40	100'	PU-60MM
80mm	3.55"	5"	11.00"	15	0.56	100'	PU-80MM

Cut Lengths : Plus 10%

Standard Lengths : 100'

Recommended Couplings : Cam and groove

Air and General Purpose Hose

Water Suction and Discharge Hose

Petroleum, Steam and Chemical Hose

Rubber Material Handling Hose

Plastic Material Handling Hose

Food Hose

Ducting

Auto Truck and Marine Hose

Fire Hose

Welding and Other Hose

Cam and Groove

Nipples and Shank Fittings

Clamps

High Pressure Fittings

Mine Fittings

Air Fittings

Valves

Sandblast

Fire Fittings

Pipe Fittings

Sheet Rubber

Index and Technical Information

Air and General Purpose Hose

Water Suction and Discharge Hose

Petroleum, Steam and Chemical Hose

Rubber Material Handling Hose

Plastic Material Handling Hose

Food Hose

Ducting

Auto Truck and Marine Hose

Fire Hose

Welding and Other Hose

Cam and Groove

Nipples, Menders and Shank Fittings

Clamps

High Pressure Fittings

Mine Fittings

Air Fittings

Valves

Sandblast

Fire Fittings

Pipe Fittings

Sheet Rubber

Index and Technical Information

PU VAC LIGHT (FOOD QUALITY)

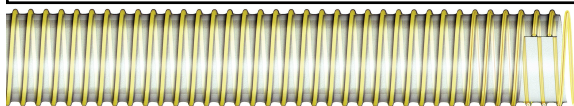

- Application** : Handling abrasive fine powders under low pressure or vacuum. Not recommended for handling liquids.
- Cover** : Corrugated clear abrasion and weather resistant Polyurethane.
- Reinforcement** : Rigid light cream PVC helix.
- Tube** : Smooth clear abrasion resistant Polyurethane.
- Temperature** : -30C to +65C (-22F to +150F)

	Nom. I.D	Nom. O.D	Vacuum (Hg)	Bend Radius	PSI	Weight (lbs)	Std Pack Qty	Part #
	1"	1.21"	20"	1.00"	30	0.10	100'	PUL-100
	1-1/4"	1.46"	20"	2.00"	30	0.11	100'	PUL-125
	1-1/2"	1.72"	15"	2.00"	25	0.14	100'	PUL-150
	2"	2.26"	15"	3.00"	25	0.21	100'	PUL-200
	2-1/2"	2.78"	15"	4.00"	20	0.32	100'	PUL-250
	3"	3.30"	15"	5.00"	15	0.40	100'	PUL-300
	4"	4.35"	12"	6.00"	15	0.52	100'	PUL-400
	5"	5.41"	10"	7.00"	10	0.75	100'	PUL-500
	6"	6.42"	10"	8.00"	7	1.02	100'	PUL-600
	8"	8.50"	8"	10.00"	5	1.50	60'	PUL-800

Cut Lengths : Plus 10%

Standard Lengths : 100'

Recommended Couplings : Cam and groove

Safety Information : PVC hose suction and pressure ratings are based on a temperature of 20C (68F), reduce ratings by 50% at maximum working temperature

BACCO - PVC WINE SUCTION (FOOD QUALITY)

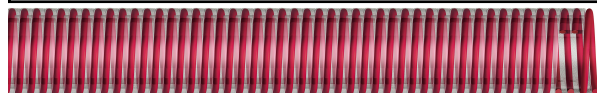

- Application** : Alcoholic beverages up to 25% alcohol content. Fruit juices, soft drinks and other liquid foodstuffs. Also suitable for dry bulk foodstuffs. Available with static wire on special order.
- Cover** : Smooth clear, food grade PVC non-marking.
- Reinforcement** : Red PVC helix.
- Tube** : Smooth clear food grade PVC, specially compounded for use with alcoholic beverages.
- Temperature** : 0C to +65C(+32F to +150F)

Nom. I.D	Nom. O.D	Vacuum (Hg)	PSI	Bend Radius	Weight (lbs)	Std Pack Qty	Part #
3/4"	1.02"	29"	100	5.00"	0.21	100'	BAC-075
1"	1.28"	29"	100	6.00"	0.27	100'	BAC-100
1-1/4"	1.55"	29"	100	7.00"	0.35	100'	BAC-125
1-1/2"	1.88"	29"	100	9.00"	0.50	100'	BAC-150
2"	2.42"	29"	100	12.00"	0.75	100'	BAC-200
2-1/2"	2.95"	29"	100	15.00"	1.10	100'	BAC-250
3"	3.50"	29"	100	18.00"	1.29	100'	BAC-300
4"	4.55"	29"	90	24.00"	2.25	100'	BAC-400
5"	5.60"	29"	75	33.00"	2.95	100'	BAC-500
30mm	38mm	29"	100	7.00"	0.34	100'	BAC-30-MM
35mm	43mm	29"	100	8.00"	0.41	100'	BAC-35-MM
38mm	47mm	29"	100	9.00"	0.50	100'	BAC-38-MM
40mm	49mm	29"	100	9.00"	0.52	100'	BAC-40-MM
45mm	54mm	29"	100	10.00"	0.62	100'	BAC-45-MM
50mm	60mm	29"	100	12.00"	0.75	100'	BAC-50-MM
55mm	65mm	29"	100	13.00"	0.86	100'	BAC-55-MM
60mm	71mm	29"	100	14.00"	0.99	100'	BAC-60-MM
70mm	82mm	29"	100	16.00"	1.22	100'	BAC-70-MM
80mm	93mm	29"	100	19.00"	1.50	100'	BAC-80-MM
90mm	103mm	29"	90	21.00"	1.77	100'	BAC-90-MM

Cut Lengths : Plus 10%

Standard Lengths : 100'

Recommended Couplings : Stainless Cam and groove or Sanitary

Air and General Purpose Hose

Water Suction and Discharge Hose

Petroleum, Steam and Chemical Hose

Rubber Material Handling Hose

Plastic Material Handling Hose

Food Hose

Ducting

Auto Truck and Marine Hose

Fire Hose

Welding and Other Hose

Cam and Groove

Nipples Menders and Shank Fittings

Clamps

High Pressure Fittings

Mine Fittings

Air Fittings

Valves

Sandblast

Fire Fittings

Pipe Fittings

Sheet Rubber

Index and Technical Information

Air and General Purpose Hose

Water Suction and Discharge Hose

Petroleum, Steam and Chemical Hose

Rubber Material Handling Hose

Plastic Material Handling Hose

Food Hose

Ducting

Auto Truck and Marine Hose

Fire Hose

Welding and Other Hose

Cam and Groove

Nipples, Menders and Shank Fittings

Clamps

High Pressure Fittings

Mine Fittings

Air Fittings

Valves

Sandblast

Fire Fittings

Pipe Fittings

Sheet Rubber

Index and Technical Information

BREWERS & BEVERAGE DISCHARGE



- Application** : Will handle a wide range of non-fatty/oily food products up to 80C (180F) where taste and aroma must not be affected.
- Cover** : Red abrasion resistant natural rubber
- Reinforcement** : Multiple layers of mildew resistant synthetic fabric
- Tube** : White smooth non-toxic FDA compliant natural rubber
- Temperature** : -35C to +80C(-30F to +180F)

	Nom. I.D	Nom. O.D	PSI	Weight (lbs)	Std Pack Qty	Part #
	3/4"	1.34"	140	0.60	100'	BRR-075
	1"	1.57"	140	0.74	100'	BRR-100
	1-1/4"	1.89"	140	0.90	100'	BRR-125
	1-1/2"	2.13"	140	0.94	100'	BRR-150
	2"	2.68"	140	1.56	100'	BRR-200-4
	2"	2.91"	140	2.19	100'	BRR-200-6
	3"	3.94"	140	3.20	100'	BRR-300

Cut Lengths : Plus 10%

Standard Lengths : 50'/100'

Product Information : Longer lengths available on request.

Recommended Couplings : Sanitary

BREWERS SUCTION HOSE



- Application** : Suction and discharge applications in the brewing and beverage industry.
- Cover** : Red abrasion resistant natural rubber
- Reinforcement** : High tensile wire helix embedded between layers of textile cords.
- Tube** : White smooth non-toxic FDA compliant natural rubber.
- Temperature** : -35C to +80C(-30F to +180F)

	Nom. I.D	Nom. O.D	Vacuum (Hg)	PSI	Bend Radius	Weight (lbs)	Std Pack Qty	Part #
	1-1/2"	1.97"	29"	150	7.00"	0.89	100'	BRS-150
	2"	2.56"	29"	150	8.00"	1.31	100'	BRS-200

Cut Lengths : Plus 10%

Standard Lengths : 50'/100'

Recommended Couplings : Sanitary

FOODFLEX PVC S&D (FOOD QUALITY)

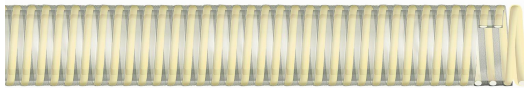

- Application** : For dry bulk foodstuffs, pharmaceuticals, cosmetics, milk, fruit and vegetable juices, soft drinks, alcoholic beverages, flour, sugar etc. Clear wall allows visual inspection of the product.
- Cover** : Clear PVC non-marking.
- Reinforcement** : Cream coloured rigid PVC helix.
- Tube** : Smooth clear PVC non-marking.
- Temperature** : 0C to +65C(+32F to +150F)

Nom. I.D	Nom. O.D	Vacuum (Hg)	PSI	Bend Radius	Weight (lbs)	Std Pack Qty	Part #
3/4"	1.02"	28"	100	4.00"	0.21	100'	FPVC-075
1"	1.28"	28"	100	4.50"	0.26	100'	FPVC-100
1-1/4"	1.53"	28"	100	6.00"	0.35	100'	FPVC-125
1-1/2"	1.85"	28"	100	7.00"	0.45	100'	FPVC-150
2"	2.40"	28"	90	8.00"	0.66	100'	FPVC-200
2-1/2"	2.95"	28"	90	12.00"	1.10	100'	FPVC-250
3"	3.50"	28"	90	14.00"	1.35	100'	FPVC-300
4"	4.60"	28"	80	18.00"	2.20	100'	FPVC-400

Cut Lengths : Plus 10%

Standard Lengths : 50'/100'

Recommended Couplings : Cam and groove or Sanitary

CLEARFLEX PVC SUCTION & DISCHARGE (FOOD QUALITY)



- Application** : For dry bulk foodstuffs, pharmaceuticals, cosmetics, milk, fruit and vegetable juices, soft drinks, alcoholic beverages, flour, sugar etc. Completely clear wall allows visual inspection of the product.
- Cover** : Clear PVC non-marking.
- Reinforcement** : Clear rigid PVC helix.
- Tube** : Smooth clear PVC non-marking.
- Temperature** : 0C to +65C(+32F to +150F)

Nom. I.D	Nom. O.D	Vacuum (Hg)	PSI	Bend Radius	Weight (lbs)	Std Pack Qty	Part #
3/4"	1.02"	28"	100	5.00"	0.21	100'	CLPVC-075
1"	1.28"	28"	100	6.00"	0.27	100'	CLPVC-100
1-1/2"	1.88"	28"	100	9.00"	0.50	100'	CLPVC-150
2"	2.42"	28"	100	12.00"	0.75	100'	CLPVC-200

Cut Lengths : Plus 10%

Standard Lengths : 100'

Recommended Couplings : Cam and groove or Sanitary

Air and General Purpose Hose

Water Suction and Discharge Hose

Petroleum, Steam and Chemical Hose

Rubber Material Handling Hose

Plastic Material Handling Hose

Food Hose

Ducting

Auto Truck and Marine Hose

Fire Hose

Welding and Other Hose

Cam and Groove

Nipples, Menders and Shank Fittings

Clamps

High Pressure Fittings

Mine Fittings

Air Fittings

Valves

Sandblast

Fire Fittings

Pipe Fittings

Sheet Rubber

Index and Technical Information

Air and General Purpose Hose

Water Suction and Discharge Hose

Petroleum, Steam and Chemical Hose

Rubber Material Handling Hose

Plastic Material Handling Hose

Food Hose

Ducting

Auto Truck and Marine Hose

Fire Hose

Welding and Other Hose

Cam and Groove

Nipples, Menders and Shank Fittings

Clamps

High Pressure Fittings

Mine Fittings

Air Fittings

Valves

Sandblast

Fire Fittings

Pipe Fittings

Sheet Rubber

Index and Technical Information

FOODFLEX RUBBER SUCTION HOSE



- Application** : Will handle most food products including fats and oils up to 95C(200F) without imparting taste or odour.
- Cover** : Grey oil and grease resistant nitrile rubber
- Reinforcement** : High tensile wire helix embedded between layers of textile cords.
- Tube** : White smooth non-toxic FDA compliant natural rubber.
- Temperature** : -32C to +93C(-25F to +200F)

	Nom. I.D	Nom. O.D	Vacuum (Hg)	PSI	Bend Radius	Weight (lbs)	Std Pack Qty	Part #
	1"	1.38"	29"	150	4.00"	0.53	100'	FFW-100
	1-1/2"	1.97"	29"	150	6.00"	0.87	100'	FFW-150
	2"	2.56"	29"	150	7.00"	1.45	100'	FFW-200
	2-1/2"	3.03"	29"	150	8.00"	1.84	100'	FFW-250
	3"	3.54"	29"	150	10.00"	2.24	100'	FFW-300
	4"	4.64"	29"	150	14.00"	3.53	100'	FFW-400

Cut Lengths : Plus 10%

Standard Lengths : 50'/100'

Recommended Couplings : Cam and groove or sanitary

POLYETHYLENE TUBING



- Application** : Instrumentation tubing and transmission lines for air, liquids and gases.
- Cover** : Low density extruded milky-white polyethylene tubing manufactured from top quality FDA approved virgin resins.
- Temperature** : -45C to 65C(-50F to +150F)

	Nom. I.D	Nom. O.D	Wall Thickness	PSI	Weight (lbs)	Std Pack Qty	Part #
	1/8"	1/4"	1/16"	150	0.01	2000'	PET-013-025
	0.17"	1/4"	0.04"	140	0.01	2000'	PET-017-025
	0.17"	1/4"	0.04"	140	0.01	100'	PET-017-025-100
	3/16"	5/16"	1/16"	150	0.02	1500'	PET-019-031
	1/4"	3/8"	1/16"	125	0.03	500'	PET-025-038
	1/4"	3/8"	1/16"	125	0.03	100'	PET-025-038-100
	3/8"	1/2"	1/16"	100	0.04	500'	PET-038-050
	3/8"	1/2"	1/16"	100	0.04	100'	PET-038-050-100
	1/2"	5/8"	1/16"	75	0.04	500'	PET-050-063
	1/2"	5/8"	1/16"	75	0.05	100'	PET-050-063-100

Cut Lengths : Plus 30%

CLEAR VINYL TUBING



- Application Cover** : Handling foodstuffs, beverages and liquids where clarity and flexibility are required.
 : Vinyl tubing is manufactured from food grade resins. It is crystal clear, non-toxic, odourless and taste free.
- Temperature** : -5C to +65C(+25F to +150F)

Nom. I.D	Nom. O.D	Wall Thickness	PSI	Std Pack Qty	Part #
1/8"	1/4"	1/16"	65	100'	CVT-013-025
3/16"	5/16"	1/16"	55	100'	CVT-019-031
1/4"	3/8"	1/16"	55	100'	CVT-025-038
5/16"	7/16"	1/16"	50	100'	CVT-031-044
3/8"	1/2"	1/16"	45	100'	CVT-038-050
3/8"	5/8"	1/8"	55	100'	CVT-038-063
1/2"	5/8"	1/16"	30	100'	CVT-050-063
1/2"	3/4"	1/8"	45	100'	CVT-050-075
5/8"	3/4"	1/16"	40	100'	CVT-063-075
5/8"	7/8"	1/8"	40	100'	CVT-063-088
3/4"	1"	1/8"	35	100'	CVT-075-100
1"	1-1/4"	1/8"	25	100'	CVT-100-125
1"	1-1/2"	1/4"	40	100'	CVT-100-150
1-1/4"	1-1/2"	1/8"	20	100'	CVT-125-150
1-1/2"	1-7/8"	3/16"	30	100'	CVT-150-188
2"	2-1/2"	1/4"	35	100'	CVT-200-250

Cut Lengths : Plus 20%
Standard Lengths : 100'

PURE GUM TUBING

Nom. I.D	Nom. O.D	Wall Thickness	Std Pack Qty	Part #
1/4"	1/2"	1/8"	50'	TPG-025-050
3/8"	5/8"	1/8"	50'	TPG-038-063
1/2"	3/4"	1/8"	50'	TPG-050-075
5/8"	7/8"	1/8"	50'	TPG-063-088
3/4"	1"	1/8"	50'	TPG-075-100
7/8"	1-1/16"	1/8"	50'	TPG-088-106
7/8"	1-1/8"	1/8"	50'	TPG-088-113
1"	1-1/4"	1/8"	50'	TPG-100-125

Cut Lengths : Plus 20%

Air and General Purpose Hose

Water Suction and Discharge Hose

Petroleum, Steam and Chemical Hose

Rubber Material Handling Hose

Plastic Material Handling Hose

Food Hose

Ducting

Auto Truck and Marine Hose

Fire Hose

Welding and Other Hose

Cam and Groove

Nipples Menders and Shank Fittings

Clamps

High Pressure Fittings

Mine Fittings

Air Fittings

Valves

Sandblast

Fire Fittings

Pipe Fittings

Sheet Rubber

Index and Technical Information

Air and General Purpose Hose

Water Suction and Discharge Hose

Petroleum, Steam and Chemical Hose

Rubber Material Handling Hose

Plastic Material Handling Hose

Food Hose

Ducting

Auto Truck and Marine Hose

Fire Hose

Welding and Other Hose

Cam and Groove

Nipples, Menders and Shank Fittings

Clamps

High Pressure Fittings

Mine Fittings

Air Fittings

Valves

Sandblast

Fire Fittings

Pipe Fittings

Sheet Rubber

Index and Technical Information

WIREVAC (FOOD QUALITY)

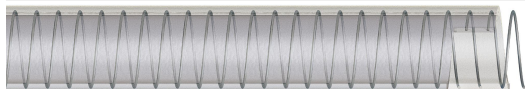

Application : An extremely flexible transparent hose for use where full vacuum performance is required while monitoring the contents of the hose. Ideal for use with most foodstuffs, cosmetics, beverages, and a wide range of chemical solutions. Also suitable for lubricating oils and animal fats.

Cover : Smooth clear PVC

Reinforcement : Spring steel wire helix

Tube : Smooth clear PVC

Temperature : -10C to +65C(15F to +150F)

	Nom. I.D	Nom. O.D	Vacuum (Hg)	PSI	Bend Radius	Weight (lbs)	Std Pack Qty	Part #
	1/4"	0.50"	28"	110	1.00"	0.09	100'	WIRE-025
	3/8"	0.63"	28"	110	1.00"	0.11	100'	WIRE-038
	1/2"	0.72"	28"	90	1.50"	0.12	100'	WIRE-050
	5/8"	0.88"	28"	90	2.00"	0.17	100'	WIRE-063
	3/4"	1.06"	28"	75	2.00"	0.24	100'	WIRE-075
	1"	1.30"	28"	75	3.00"	0.35	100'	WIRE-100
	1-1/4"	1.62"	28"	60	3.50"	0.50	100'	WIRE-125
	1-1/2"	1.85"	28"	60	4.00"	0.75	100'	WIRE-150
	2"	2.36"	28"	60	5.00"	1.09	100'	WIRE-200
	3"	3.50"	28"	45	12.00"	1.84	100'	WIRE-300

Cut Lengths : Plus 10%

Standard Lengths : 100'

Safety Information : This hose has no fabric reinforcement and normally should not be used under pressure for service at temperatures above 25C (75F). Please consult us for details

SUPER WIREVAC (FOOD QUALITY)



Air and General Purpose Hose

Water Suction and Discharge Hose

Petroleum, Steam and Chemical Hose

Rubber Material Handling Hose

Plastic Material Handling Hose

Food Hose

Ducting

Auto Truck and Marine Hose

Fire Hose

Welding and Other Hose

Cam and Groove

Nipples, Menders and Shank Fittings

Clamps

High Pressure Fittings

Mine Fittings

Air Fittings

Valves

Sandblast

Fire Fittings

Pipe Fittings

Sheet Rubber

Index and Technical Information

Application : An extremely flexible transparent hose for use where full vacuum performance and higher working pressures are required while monitoring the contents of the hose. Ideal for use with most foodstuffs, cosmetics, beverages, and a wide range of chemical solutions. Also suitable for lubricating oils and animal fats.

Cover : Smooth clear PVC

Reinforcement : Spring steel wire helix and plies of polyester yarn

Tube : Smooth clear PVC

Temperature : -10C to +65C(15F to +150F)

Nom. I.D	Nom. O.D	Vacuum (Hg)	PSI	Bend Radius	Weight (lbs)	Std Pack Qty	Part #
3/8"	0.73"	28"	250	1.20"	0.18	100'	WIRES-038
1/2"	0.81"	28"	250	1.50"	0.20	100'	WIRES-050
5/8"	0.98"	28"	250	2.00"	0.25	100'	WIRES-063
3/4"	1.17"	28"	200	2.40"	0.34	100'	WIRES-075
1"	1.38"	28"	200	3.00"	0.44	100'	WIRES-100
1-1/4"	1.69"	28"	150	3.70"	0.60	100'	WIRES-125
1-1/2"	1.97"	28"	150	4.50"	0.78	100'	WIRES-150
2"	2.50"	28"	150	5.50"	1.20	100'	WIRES-200
3"	3.55"	28"	100	13.00"	2.15	100'	WIRES-300

Cut Lengths : Plus 10%

Standard Lengths : 100'

TPR/RFH



Application : A wire reinforced, TPR elastomer, with good resistance to abrasion, chemicals and weathering. Excellent low and high temperature properties make this a truly versatile indoor/outdoor ducting. For general dust and fume extraction, sawdust and other mildly abrasive powders.

Temperature : -51C to +135C(-60F to +275F Intermittent to +300F)

Nom. I.D	PSI	Bend Radius	Vacuum (Hg)	Weight (lbs)	Part #
2"	17	3.50"	29"	0.32	TPR-200
2-1/2"	13	4.00"	28"	0.31	TPR-250
3"	10	4.25"	28"	0.48	TPR-300
3-1/2"	10	5.25"	20"	0.62	TPR-350
4"	10	6.50"	25"	0.72	TPR-400
5"	9	8.00"	15"	0.84	TPR-500
6"	8	8.75"	12"	1.00	TPR-600
7"	7	10.50"	10"	1.12	TPR-700
8"	6	12.00"	6"	1.24	TPR-800
10"	4	12.50"	5"	1.52	TPR-1000
12"	4	13.75"	4"	1.84	TPR-1200
14"	2	18.00"	2"	2.64	TPR-1400

Standard Lengths : 25'/50'/100'

SUPER VAC-U-FLEX CUFF

Description	Weight (lbs)	Part #
3/4" SUPER VACUFLEX CUFF	0.06	SVACC-075
1" SUPER VACUFLEX CUFF	0.06	SVACC-100
1-1/4" SUPER VACUFLEX CUFF	0.07	SVACC-125
1-1/2" SUPER VACUFLEX CUFF	0.16	SVACC-150
2" SUPER VACUFLEX CUFF	0.20	SVACC-200
2-1/2" SUPER VACUFLEX CUFF	0.25	SVACC-250
3" SUPER VACUFLEX CUFF	0.55	SVACC-300

Air and General Purpose Hose

SUPER VAC-U-FLEX

Water Suction and Discharge Hose



Application : High tensile fibre reinforced PVC cover bonded to a coated spring steel wire helix.
Temperature : -30C to +65C(-20F to +150F)

	Nom. I.D	Nom. O.D	PSI	Bend Radius	Vacuum (Hg)	Weight (lbs)	Part #
Rubber Material Handling Hose	3/4"	0.88"	13	0.50"	27"	0.11	CMD-075
	1"	1.06"	10	0.50"	27"	0.14	CMD-100
	1-1/4"	1.50"	45	0.88"	27"	0.18	SVAC-125
Plastic Material Handling Hose	1-1/2"	1.75"	36	1.12"	26"	0.20	SVAC-150
	2"	2.35"	26	1.63"	25"	0.25	SVAC-200
Food Hose	2-1/2"	2.85"	20	2.19"	24"	0.30	SVAC-250
Ducting	3"	3.40"	20	2.48"	24"	0.40	SVAC-300
	4"	4.40"	14	3.26"	18"	0.50	SVAC-400

Standard Lengths : 1-1/4" to 2-1/2" - 50' , 3" and 4" - 25'

Petroleum, Steam and Chemical Hose

Rubber Material Handling Hose

Plastic Material Handling Hose

Food Hose

Ducting

Auto Truck and Marine Hose

Fire Hose

Welding and Other Hose

Cam and Groove

Nipples, Menders and Shank Fittings

Clamps

High Pressure Fittings

Mine Fittings

Air Fittings

Valves

Sandblast

Fire Fittings

Pipe Fittings

Sheet Rubber

Index and Technical Information

NC1



Application : Neoprene impregnated polyester fabric, enclosed steel wire helix; integral liner. One ply construction for general purpose applications.
Temperature : -40C to +121C(-40F to +250F)

	Nom. I.D	PSI	Bend Radius	Vacuum (Hg)	Weight (lbs)	Part #
	2"	30	1.80"	29"	0.16	NC1-200-25
	2-1/2"	25	2.00"	29"	0.24	NC1-250-25
	3"	24	2.50"	25"	0.40	NC1-300-25
	4"	18	3.00"	20"	0.56	NC1-400-25
	5"	12	3.50"	15"	0.64	NC1-500-25
	6"	8	4.00"	12"	0.72	NC1-600-25
	8"	6	5.50"	8"	0.96	NC1-800-25
	10"	4	6.00"	4"	1.28	NC1-1000-25
	12"	3	7.00"	3"	1.60	NC1-1200-25

Standard Lengths : 10'/25

NC2



Application : Neoprene impregnated polyester fabric, enclosed steel wire helix; integral liner. Two ply construction for general purpose applications.
Temperature : -40C to +121C(-40F to +250F)

Nom. I.D	Nom. O.D	PSI	Bend Radius	Vacuum (Hg)	Weight (lbs)	Part #
1-1/4"	1.63"	41	1.10"	29"	0.16	NC2-125-25
1-1/2"	1.88"	41	1.30"	29"	0.24	NC2-150-25
2"	2.38"	33	1.80"	28"	0.24	NC2-200-25
2-1/2"	2.88"	27	2.30"	28"	0.32	NC2-250-25
3"	3.38"	23	2.70"	27"	0.48	NC2-300-25
4"	4.38"	18	3.40"	25"	0.64	NC2-400-25
5"	5.38"	14	3.90"	18"	0.80	NC2-500-25
6"	6.38"	14	4.50"	14"	0.92	NC2-600-25
7"	7.38"	12	5.00"	12"	0.96	NC2-700-25
8"	8.38"	11	5.50"	10"	1.04	NC2-800-25
10"	10.38"	10	6.80"	5"	1.36	NC2-1000-25
12"	12.50"	8	9.40"	3"	1.68	NC2-1200-25
14"	14.50"	6	11.20"	2"	2.48	NC2-1400-25
16"	16.50"	5	12.40"	2"	2.72	NC2-1600-25
18"	18.50"	3	13.50"	1"	3.12	NC2-1800-25
20"	20.50"	2	15.00"	0"	3.44	NC2-2000-25

Standard Lengths : 10'/25

VAC-U-LOK



Application : Interlocked EVA hose, non wire construction for crush resistance.
Temperature : -54C to +60C(-65F to +140F)

Nom. I.D	PSI	Bend Radius	Vacuum (Hg)	Weight (lbs)	Part #
1-1/4"	22	3.50"	20"	0.21	VUL-125
1-1/2"	20	4.00"	18"	0.28	VUL-150
2"	14	4.30"	18"	0.39	VUL-200
2-1/2"	12	4.60"	16"	0.54	VUL-250
3"	8	5.10"	11"	0.73	VUL-300

Standard Lengths : 1 1/4" and 1 1/2" - 50' -- other sizes - 25'

Air and General Purpose Hose

Water Suction and Discharge Hose

Petroleum, Steam and Chemical Hose

Rubber Material Handling Hose

Plastic Material Handling Hose

Food Hose

Ducting

Auto Truck and Marine Hose

Fire Hose

Welding and Other Hose

Cam and Groove

Nipples Menders and Shank Fittings

Clamps

High Pressure Fittings

Mine Fittings

Air Fittings

Valves

Sandblast

Fire Fittings

Pipe Fittings

Sheet Rubber

Index and Technical Information

Air and General Purpose Hose

VAC-U-LOK CUFF

Description	Weight (lbs)	Part #
1-1/4" VACULOK CUFF	0.09	VULC-125
1-1/2" VACULOK CUFF	0.10	VULC-150
2" VACULOK CUFF	0.26	VULC-200
1-1/2" VACULOK MENDER	0.16	VULM-150

Water Suction and Discharge Hose

Petroleum, Steam and Chemical Hose

Rubber Material Handling Hose

SPIRATUBE - TDS & TDHS



Plastic Material Handling Hose

Food Hose

Ducting

Application : Single ply (TDS) or 2 ply (TDHS) vinyl-coated fabric with orange vinyl scuff-strip, spring steel wire helix and smooth bore. Meets UL 940-V flammability rating.
Temperature : -10C to +94C(15F to +200F)

	Nom. I.D	PSI	Bend Radius	Vacuum (Hg)	Weight (lbs)	Part #
Auto Truck and Marine Hose	3"	24	1.50"	22"	0.50	TDS-300
	3"	28	1.50"	26"	0.60	TDHS-300
Fire Hose	4"	18	2.00"	17"	0.60	TDS-400
Welding and Other Hose	4"	24	2.00"	24"	0.80	TDHS-400
	5"	12	2.50"	14"	0.70	TDS-500
Cam and Groove	5"	20	2.50"	18"	0.80	TDHS-500
	6"	10	3.00"	10"	1.00	TDS-600
Nipples and Shank Fittings	6"	18	3.00"	14"	1.20	TDHS-600
	7"	8	3.50"	7"	1.20	TDS-700
	7"	14	3.50"	11"	1.40	TDHS-700
Clamps	8"	7	4.00"	6"	1.30	TDS-800
	8"	12	4.00"	9"	1.50	TDHS-800
High Pressure Fittings	10"	6	5.00"	4"	1.60	TDS-1000
	10"	8	5.00"	6"	2.00	TDHS-1000
Mine Fittings	12"	5	6.00"	2"	2.00	TDS-1200
Air Fittings	12"	6	6.00"	3"	2.40	TDHS-1200

Standard Lengths : 25'

Valves

Sandblast

Fire Fittings

Pipe Fittings

Sheet Rubber

Index and Technical Information

TPU VAC-U-FLEX



Application : A flexible smooth clear polyurethane elastomer bonded to a coated spring steel wire helix. Features high abrasion and puncture resistance and excellent chemical and oil resistance.

Temperature : -40C to +93C(-40F to +200F)

Nom. I.D	PSI	Bend Radius	Vacuum (Hg)	Weight (lbs)	Part #
3/4"	16	0.75"	28"	0.16	TPU-075
1"	15	1.00"	28"	0.16	TPU-100
1-1/4"	13	1.25"	28"	0.20	TPU-125
1-1/2"	10	1.50"	26"	0.24	TPU-150
2"	8	2.00"	22"	0.32	TPU-200
2-1/2"	7	2.50"	20"	0.32	TPU-250
3"	6	3.00"	16"	0.40	TPU-300
4"	5	4.00"	12"	0.48	TPU-400
5"	5	5.00"	10"	0.88	TPU-500
6"	4	6.00"	7"	1.20	TPU-600

Standard Lengths : 25'

TPE VAC-U-FLEX



Application : Industrial weight black thermoplastic elastomer bonded to a coated spring steel wire helix. Features high abrasion and solvent resistance.

Temperature : -40C to +121C(-40F to 250F)

Nom. I.D	PSI	Bend Radius	Vacuum (Hg)	Weight (lbs)	Part #
3/4"	10	0.75"	28"	0.16	TPE-075
1"	10	1.00"	28"	0.16	TPE-100
1-1/4"	10	1.25"	28"	0.24	TPE-125
1-1/2"	10	1.50"	28"	0.32	TPE-150
2"	10	2.00"	28"	0.40	TPE-200
2-1/2"	10	2.50"	28"	0.48	TPE-250
3"	7	3.00"	28"	0.56	TPE-300
4"	6	4.00"	28"	0.64	TPE-400
5"	5	5.00"	24"	0.88	TPE-500
6"	4	6.00"	18"	0.96	TPE-600

Standard Lengths : 25'

Air and General Purpose Hose

Water Suction and Discharge Hose

Petroleum, Steam and Chemical Hose

Rubber Material Handling Hose

Plastic Material Handling Hose

Food Hose

Ducting

Auto Truck and Marine Hose

Fire Hose

Welding and Other Hose

Cam and Groove

Nipples Menders and Shank Fittings

Clamps

High Pressure Fittings

Mine Fittings

Air Fittings

Valves

Sandblast

Fire Fittings

Pipe Fittings

Sheet Rubber

Index and Technical Information

Air and General Purpose Hose

Water Suction and Discharge Hose

Petroleum, Steam and Chemical Hose

Rubber Material Handling Hose

Plastic Material Handling Hose

Food Hose

Ducting

Auto Truck and Marine Hose

Fire Hose

Welding and Other Hose

Cam and Groove

Nipples, Menders and Shank Fittings

Clamps

High Pressure Fittings

Mine Fittings

Air Fittings

Valves

Sandblast

Fire Fittings

Pipe Fittings

Sheet Rubber

Index and Technical Information

U1 FLEX FLYTE



Application

: Neoprene-coated fiberglass fabric cover, corrosion resistant steel wire helix.

Neoprene coated fiberglass cord for additional reinforcement, lightweight, maximum flexibility. Meets UL-940VO flammability and UL478. Can be spliced for longer lengths

Temperature

: -54C to +121C(-65F to +250F)

	Nom. I.D	Nom. O.D	PSI	Bend Radius	Vacuum (Hg)	Weight (lbs)	Part #
	1-1/4"	1.37"	18	0.96"	18"	0.17	U1-125
	1-1/2"	1.62"	18	1.20"	18"	0.17	U1-150
	1-3/4"	1.87"	16	1.51"	16"	0.34	U1-175
	2"	2.12"	15	1.72"	14"	0.34	U1-200
	2-1/4"	2.39"	14	2.05"	13"	0.34	U1-225
	2-1/2"	2.65"	14	2.15"	13"	0.34	U1-250
	3"	3.15"	13	2.55"	11"	0.50	U1-300
	3-1/2"	3.70"	12.5	3.10"	10"	0.50	U1-350
	4"	4.18"	12	3.60"	10"	0.50	U1-400
	4-1/2"	4.67"	11	4.15"	9"	0.50	U1-450
	5"	5.17"	10	4.60"	8"	0.67	U1-500
	5-1/2"	5.67"	9.5	5.20"	6"	0.67	U1-550
	6"	6.17"	7	5.65"	5"	0.67	U1-600
	6-1/2"	6.69"	7	6.12"	5"	0.67	U1-650
	7"	7.19"	6	6.68"	4"	0.83	U1-700
	8"	8.19"	5	7.58"	3"	0.83	U1-800
	9"	9.19"	4.3	8.50"	2"	0.83	U1-900
	10"	10.23"	3	9.60"	1"	1.00	U1-1000
	11"	11.23"	2.2	10.30"	1"	1.17	U1-1100
	12"	12.23"	1.7	11.40"	1"	1.17	U1-1200

Standard Lengths : 12'

L1 FLEX FLYTE



Application : Similar to U-1 but having a liner of Neoprene coated fibreglass for improved air flow. Meets UL-94VO flammability. Can be spliced.
Temperature : -54C to +121C(-65F to +250F)

Nom. I.D	Nom. O.D	PSI	Bend Radius	Vacuum (Hg)	Weight (lbs)	Part #
1-1/4"	1.37"	26	1.22"	26"	0.34	L1-125
1-1/2"	1.62"	25	1.45"	24"	0.34	L1-150
1-3/4"	1.87"	23	1.68"	22"	0.34	L1-175
2"	2.12"	24	1.88"	20"	0.34	L1-200
2-1/4"	2.39"	21	2.18"	19"	0.34	L1-225
2-1/2"	2.65"	20	2.38"	18"	0.34	L1-250
3"	3.15"	19	2.90"	16"	0.50	L1-300
3-1/2"	3.70"	18	3.38"	14"	0.67	L1-350
4"	4.18"	16	3.87"	13"	0.67	L1-400
4-1/2"	4.67"	15	4.36"	11"	0.83	L1-450
5"	5.17"	14	4.88"	10"	1.00	L1-500
5-1/2"	5.67"	13	5.39"	8"	1.00	L1-550
6"	6.17"	11	5.89"	7"	1.17	L1-600
6-1/2"	6.69"	11	6.38"	6"	1.17	L1-650
7"	7.19"	9	6.88"	5"	1.17	L1-700
8"	8.19"	7	7.84"	3"	1.33	L1-800
9"	9.19"	6	8.86"	2"	1.33	L1-900
10"	10.23"	5	9.82"	2"	1.50	L1-1000
11"	11.23"	4	10.83"	1"	1.50	L1-1100
12"	12.23"	4	11.82"	1"	1.67	L1-1200

Standard Lengths : 12'

Air and General Purpose Hose

Water Suction and Discharge Hose

Petroleum, Steam and Chemical Hose

Rubber Material Handling Hose

Plastic Material Handling Hose

Food Hose

Ducting

Auto Truck and Marine Hose

Fire Hose

Welding and Other Hose

Cam and Groove

Nipples Menders and Shank Fittings

Clamps

High Pressure Fittings

Mine Fittings

Air Fittings

Valves

Sandblast

Fire Fittings

Pipe Fittings

Sheet Rubber

Index and Technical Information

Air and General Purpose Hose

Water Suction and Discharge Hose

Petroleum, Steam and Chemical Hose

Rubber Material Handling Hose

Plastic Material Handling Hose

Food Hose

Ducting

Auto Truck and Marine Hose

Fire Hose

Welding and Other Hose

Cam and Groove

Nipples Menders and Shank Fittings

Clamps

High Pressure Fittings

Mine Fittings

Air Fittings

Valves

Sandblast

Fire Fittings

Pipe Fittings

Sheet Rubber

Index and Technical Information

U9 FLEX FLYTE



Application : Silicone rubber coated fibreglass fabric with spring steel wire helix. Offers lightweight and maximum flexibility coupled with high temperature resistance

Temperature : -59C to +260C(-75F to +500F)

	Nom. I.D	Nom. O.D	PSI	Bend Radius	Vacuum (Hg)	Weight (lbs)	Part #
Rubber Material Handling Hose	1-1/2"	1.62"	18	1.20"	18"	0.34	U9-150
	1-3/4"	1.87"	16	1.51"	16"	0.34	U9-175
Plastic Material Handling Hose	2"	2.12"	15	1.72"	14"	0.34	U9-200
	2-1/4"	2.39"	14	2.05"	13"	0.34	U9-225
Food Hose	2-1/2"	2.65"	14	2.15"	13"	0.34	U9-250
Ducting	3"	3.15"	13	2.55"	11"	0.50	U9-300
	3-1/2"	3.70"	12.5	3.10"	10"	0.50	U9-350
Auto Truck and Marine Hose	4"	4.18"	12	3.60"	10"	0.67	U9-400
	4-1/2"	4.67"	11	4.15"	9"	0.67	U9-450
Fire Hose	5"	5.17"	10	4.60"	8"	0.83	U9-500
	5-1/2"	5.67"	9.5	5.20"	6"	0.83	U9-550
Welding and Other Hose	6"	6.17"	7	5.65"	5"	1.00	U9-600
	6-1/2"	6.69"	7	6.12"	5"	1.00	U9-650
Cam and Groove	7"	7.19"	6	6.68"	4"	1.00	U9-700
	8"	8.19"	5	7.58"	3"	1.00	U9-800
Nipples Menders and Shank Fittings	9"	9.19"	4.3	8.50"	2"	1.17	U9-900
	10"	10.23"	3	9.60"	1"	1.33	U9-1000
Clamps	11"	11.23"	2.2	10.30"	1"	1.50	U9-1100
	12"	12.23"	1.7	11.40"	1"	1.67	U9-1200

Standard Lengths : 12'

L9 FLEX FLYTE



Application : Similar to U-9 but having a silicone rubber coated fiberglass liner for smoother flow and higher pressure ratings
Temperature : -59C to +260C(-75F to +500F)

Nom. I.D	Nom. O.D	PSI	Bend Radius	Vacuum (Hg)	Weight (lbs)	Part #
1-1/4"	1.37"	26	1.22"	26"	0.34	L9-125
1-1/2"	1.62"	25	1.45"	24"	0.34	L9-150
1-3/4"	1.87"	23	1.68"	22"	0.34	L9-175
2"	2.12"	24	1.88"	20"	0.34	L9-200
2-1/4"	2.39"	21	2.18"	19"	0.34	L9-225
2-1/2"	2.65"	20	2.38"	18"	0.34	L9-250
3"	3.15"	19	2.90"	16"	0.50	L9-300
3-1/2"	3.70"	18	3.38"	14"	0.61	L9-350
4"	4.18"	16	3.87"	13"	0.67	L9-400
4-1/2"	4.67"	15	4.36"	11"	0.83	L9-450
5"	5.17"	14	4.88"	10"	1.00	L9-500
5-1/2"	5.67"	13	5.39"	8"	1.00	L9-550
6"	6.17"	11	5.89"	7"	1.17	L9-600
6-1/2"	6.69"	11	6.38"	6"	1.17	L9-650
7"	7.19"	9	6.88"	5"	1.17	L9-700
8"	8.19"	7	7.84"	3"	1.33	L9-800
9"	9.19"	6	8.86"	2"	1.50	L9-900
10"	10.23"	5	9.82"	2"	1.50	L9-1000
11"	11.23"	4	10.83"	1"	1.67	L9-1100
12"	12.23"	4	11.82"	1"	1.83	L9-1200

Standard Lengths : 12'

Air and General Purpose Hose

Water Suction and Discharge Hose

Petroleum, Steam and Chemical Hose

Rubber Material Handling Hose

Plastic Material Handling Hose

Food Hose

Ducting

Auto Truck and Marine Hose

Fire Hose

Welding and Other Hose

Cam and Groove

Nipples Menders and Shank Fittings

Clamps

High Pressure Fittings

Mine Fittings

Air Fittings

Valves

Sandblast

Fire Fittings

Pipe Fittings

Sheet Rubber

Index and Technical Information

Air and General Purpose Hose

Water Suction and Discharge Hose

Petroleum, Steam and Chemical Hose

Rubber Material Handling Hose

Plastic Material Handling Hose

Food Hose

Ducting

Auto Truck and Marine Hose

Fire Hose

Welding and Other Hose

Cam and Groove

Nipples, Menders and Shank Fittings

Clamps

High Pressure Fittings

Mine Fittings

Air Fittings

Valves

Sandblast

Fire Fittings

Pipe Fittings

Sheet Rubber

Index and Technical Information

1PNEPW



Application : Wide pitch, Neoprene impregnated cotton fabric with enclosed spring steel wire helix. Built with polyester fabric reinforcement for better moisture resistance. Ideal for applications where maximum flexibility and retractibility are required.

Temperature : -40C to +121C(-40F to +250F)

Nom. I.D	PSI	Bend Radius	Vacuum (Hg)	Weight (lbs)	Part #
4"	13	3.00"	N.R	0.29	1PNEPW-400
6"	8	3.50"	N.R	0.53	1PNEPW-600
8"	6	5.00"	N.R	0.70	1PNEPW-800
10"	4	6.50"	N.R	0.78	1PNEPW-1000
12"	3	7.50"	N.R	1.03	1PNEPW-1200
14"	3	8.50"	N.R	1.08	1PNEPW-1400
16"	2	9.50"	N.R	1.24	1PNEPW-1600
18"	2	10.50"	N.R	1.39	1PNEPW-1800
20"	1	12.00"	N.R	1.54	1PNEPW-2000
24"	1	13.00"	N.R	1.85	1PNEPW-2400

Standard Lengths : 25'

DUCT CONNECTOR

Description	Weight (lbs)	Part #
4" DUCT CONNECTOR STAINLESS	0.03	DCON-400
5" DUCT CONNECTOR STAINLESS	0.08	DCON-500
6" DUCT CONNECTOR STAINLESS	0.14	DCON-600
7" DUCT CONNECTOR STAINLESS	0.15	DCON-700
8" DUCT CONNECTOR STAINLESS	0.22	DCON-800
9" DUCT CONNECTOR STAINLESS	0.76	DCON-900
10" DUCT CONNECTOR STAINLESS	1.30	DCON-1000
12" DUCT CONNECTOR STAINLESS	1.50	DCON-1200

DURATHANE LD/ "UFD"



Air and General Purpose Hose

Water Suction and Discharge Hose

Petroleum, Steam and Chemical Hose

Rubber Material Handling Hose

Plastic Material Handling Hose

Food Hose

Ducting

Auto Truck and Marine Hose

Fire Hose

Welding and Other Hose

Cam and Groove

Nipples, Menders and Shank Fittings

Clamps

High Pressure Fittings

Mine Fittings

Air Fittings

Valves

Sandblast

Fire Fittings

Pipe Fittings

Sheet Rubber

Index and Technical Information

Application : A wire reinforced two ply polyurethane duct with excellent abrasion resistance, low temperature and chemical resistance. MD and HD version available for extra abrasion and puncture resistance.

Temperature : -51C to +93C(-60F to +200F)

Nom. I.D	Nom. O.D	PSI	Bend Radius	Vacuum (Hg)	Weight (lbs)	Part #
2"	2.29"	33	2.50"	29"	0.40	DURLD-200
2-1/2"	2.79"	30	3.00"	29"	0.43	DURLD-250
3"	3.32"	27	3.50"	29"	0.64	DURLD-300
4"	4.34"	18	4.50"	28"	0.80	DURLD-400
5"	5.34"	16	5.50"	26"	0.96	DURLD-500
6"	6.37"	14	6.25"	24"	1.44	DURLD-600
7"	7.40"	12	7.25"	18"	1.52	DURLD-700
8"	8.40"	11	8.75"	14"	1.68	DURLD-800
10"	10.41"	9	11.25"	6"	1.92	DURLD-1000
12"	12.41"	7	13.25"	5"	2.24	DURLD-1200
14"	14.56"	4	15.50"	3"	2.76	DURLD-1400
16"	16.59"	2	18.00"	3"	3.04	DURLD-1600

Standard Lengths : 25'

Air and General Purpose Hose

Water Suction and Discharge Hose

Petroleum, Steam and Chemical Hose

Rubber Material Handling Hose

Plastic Material Handling Hose

Food Hose

Ducting

Auto Truck and Marine Hose

Fire Hose

Welding and Other Hose

Cam and Groove

Nipples, Menders and Shank Fittings

Clamps

High Pressure Fittings

Mine Fittings

Air Fittings

Valves

Sandblast

Fire Fittings

Pipe Fittings

Sheet Rubber

Index and Technical Information

DURATHANE MD/ "UFD.045"



Application

: A wire reinforced three ply polyurethane duct with excellent abrasion resistance, low temperature and chemical resistance. LD version available for lighter duty applications and HD version available for extra abrasion and puncture resistance.

Temperature

: -51C to +93C (-60F to +200F)

	Nom. I.D	Nom. O.D	PSI	Bend Radius	Vacuum (Hg)	Weight (lbs)	Part #
	2"	2.32"	35	3.00"	29"	0.37	DURMD-200
	2-1/2"	2.82"	32	4.00"	29"	0.46	DURMD-250
	3"	3.34"	30	5.00"	29"	0.52	DURMD-300
	4"	4.36"	21	6.50"	29"	0.96	DURMD-400
	5"	5.36"	18	7.50"	26"	1.08	DURMD-500
	6"	6.40"	16	8.50"	23"	1.54	DURMD-600
	7"	7.43"	14	10.50"	18"	1.79	DURMD-700
	8"	8.43"	12	12.00"	13"	2.04	DURMD-800
	10"	10.43"	10	14.00"	6"	2.57	DURMD-1000
	12"	12.43"	8	16.00"	5"	3.08	DURMD-1200
	14"	14.60"	7	18.00"	4"	3.58	DURMD-1400

Standard Lengths : 25'

SLP10 FLEXVENT



Application : Grey flame retardent, vinyl coated woven fibreglass fabric permanently bonded to a PVC coated spring steel helix.
Temperature : -40C to +121C(-40F to +250F)

Nom. I.D	PSI	Bend Radius	Weight (lbs)	Part #
2"	0.36	2.00"	0.10	SLP-200
3"	0.36	3.00"	0.13	SLP-300
4"	0.36	4.00"	0.16	SLP-400
5"	0.36	5.00"	0.17	SLP-500
6"	0.36	6.00"	0.20	SLP-600
7"	0.36	7.00"	0.24	SLP-700
8"	0.36	8.00"	0.25	SLP-800
9"	0.36	9.00"	0.26	SLP-900
10"	0.36	10.00"	0.33	SLP-1000
12"	0.36	12.00"	0.49	SLP-1200
14"	0.36	14.00"	0.61	SLP-1400

Standard Lengths : 25'

Air and General Purpose Hose

Water Suction and Discharge Hose

Petroleum, Steam and Chemical Hose

Rubber Material Handling Hose

Plastic Material Handling Hose

Food Hose

Ducting

Auto Truck and Marine Hose

Fire Hose

Welding and Other Hose

Cam and Groove

Nipples, Menders and Shank Fittings

Clamps

High Pressure Fittings

Mine Fittings

Air Fittings

Valves

Sandblast

Fire Fittings

Pipe Fittings

Sheet Rubber

Index and Technical Information

MARINE EXHAUST HARDWALL



- Application** : Marine exhaust applications, and other general applications where non-standard sizes are specified. Meets SAEJ 2006 R1
- Cover** : Black heat and weather resistant synthetic rubber with blue identification stripe.
- Reinforcement** : High tensile wire helix embedded between layers of textile cords.
- Tube** : Black heat resistant rubber specially compounded for wet marine exhaust service.
- Temperature** : -40C to +100C(-40F to +212F)

Nom. I.D	Nom. O.D	Weight (lbs)	Std Pack Qty	Part #
7/8"	1.25"	0.50	100'	MXH-088
1"	1.38"	0.57	100'	MXH-100
1-1/8"	1.40"	0.58	100'	MXH-113
1-1/4"	1.69"	0.68	100'	MXH-125
1-5/16"	1.60"	0.73	100'	MXH-131
1-3/8"	1.81"	0.75	100'	MXH-138
1-1/2"	1.81"	0.82	100'	MXH-150
1-5/8"	1.97"	1.10	100'	MXH-163
1-3/4"	2.09"	1.06	100'	MXH-175
1-7/8"	2.20"	1.14	100'	MXH-188
2"	2.32"	1.33	100'	MXH-200
2-1/8"	2.50"	1.39	100'	MXH-213
2-1/4"	2.60"	1.54	100'	MXH-225
2-3/8"	2.68"	1.71	100'	MXH-238
2-1/2"	2.81"	1.82	100'	MXH-250
2-5/8"	3.00"	2.06	100'	MXH-263
2-7/8"	3.35"	2.08	100'	MXH-288
3"	3.54"	2.12	100'	MXH-300
3-1/8"	3.70"	2.35	100'	MXH-313
3-1/2"	4.09"	2.62	100'	MXH-350
4"	4.57"	3.02	100'	MXH-400
4-1/8"	4.64"	2.75	100'	MXH-413
4-1/2"	5.12"	3.57	100'	MXH-450
5"	5.55"	3.59	100'	MXH-500

Cut Lengths : Plus 10%
Standard Lengths : 100'
Recommended Couplings : Cam and groove, combination nipples

Air and General Purpose Hose

Water Suction and Discharge Hose

Petroleum, Steam and Chemical Hose

Rubber Material Handling Hose

Plastic Material Handling Hose

Food Hose

Ducting

Auto Truck and Marine Hose

Fire Hose

Welding and Other Hose

Cam and Groove

Nipples, Menders and Shank Fittings

Clamps

High Pressure Fittings

Mine Fittings

Air Fittings

Valves

Sandblast

Fire Fittings

Pipe Fittings

Sheet Rubber

Index and Technical Information

MARINE EXHAUST SOFTWALL



- Application** : Marine exhaust applications, and other general applications where non-standard sizes are specified. Meets SAEJ 2006 R1
- Cover** : Black heat and weather resistant synthetic rubber with blue identification stripe.
- Reinforcement** : Multiple plies of synthetic fabric
- Tube** : Black heat resistant rubber specially compounded for wet marine exhaust service.
- Temperature** : -40C to +100C(-40F to +212F)

	Nom. I.D	Nom. O.D	Weight (lbs)	Std Pack Qty	Part #
	7/8"	1.26"	0.44	100'	MXS-088
	1"	1.38"	0.49	100'	MXS-100
	1-1/8"	1.50"	0.52	100'	MXS-113
	1-1/4"	1.69"	0.68	100'	MXS-125
	1-5/16"	1.73"	0.70	100'	MXS-131
	1-3/8"	1.81"	0.77	100'	MXS-138
	1-1/2"	1.93"	0.79	100'	MXS-150
	1-5/8"	2.13"	0.93	100'	MXS-163
	1-3/4"	2.20"	1.01	100'	MXS-175
	1-7/8"	2.32"	1.01	100'	MXS-188
	2"	2.50"	1.21	100'	MXS-200
	2-1/8"	2.62"	1.25	100'	MXS-213
	2-1/4"	2.76"	1.38	100'	MXS-225
	2-3/8"	2.91"	1.55	100'	MXS-238
	2-1/2"	3.05"	1.63	100'	MXS-250
	2-5/8"	3.23"	1.85	100'	MXS-263
	2-7/8"	3.42"	1.88	100'	MXS-288
	3"	3.54"	1.90	100'	MXS-300
	3-1/8"	3.70"	2.09	100'	MXS-313
	3-1/2"	4.09"	2.30	100'	MXS-350
	4"	4.57"	2.41	100'	MXS-400
	4-1/8"	4.13"	2.53	100'	MXS-413
	4-1/2"	5.12"	3.23	100'	MXS-450

Cut Lengths : Plus 10%

Standard Lengths : 100'

Recommended Couplings : Cam and groove, combination nipples

MARINE FUEL FILL - HARDWALL



Application	: For use in all marine fuel fill applications. Meets S.A.E. J1527 type A2.
Cover	: Black oil and weather resistant synthetic rubber with blue stripe.
Reinforcement	: A high tensile steel helix wire embedded between textile cords.
Tube	: Black oil and fuel resistant nitrile rubber.
Temperature	: -40C to +80C(-40F to +180F)

Nom. I.D	Nom. O.D	Vacuum (Hg)	PSI	Bend Radius	Weight (lbs)	Std Pack Qty	Part #
1-1/2"	1.85"	28"	150	3.00"	0.70	100'	MFH-150
1-5/8"	2.01"	28"	150	3.50"	0.80	100'	MFH-163
1-3/4"	2.13"	28"	150	4.00"	0.85	100'	MFH-175
1-7/8"	2.28"	28"	150	6.00"	0.90	100'	MFH-188
2"	2.40"	28"	150	8.00"	0.98	100'	MFH-200
2-1/8"	2.52"	28"	150	8.50"	1.02	100'	MFH-213
2-1/4"	2.64"	28"	150	9.00"	1.07	100'	MFH-225
2-3/8"	2.76"	28"	150	10.00"	1.14	100'	MFH-238

Cut Lengths : Plus 10%

Standard Lengths : 100'

Recommended Couplings : Cam and groove, combination nipples

FUEL LINE



Application	: Fuel and vapour emission lines, meets SAE 30R7 specification and is USCG Type B and BIA approved.
Cover	: Black heat and fuel resistant Hypalon.
Reinforcement	: Two layers of synthetic yarns.
Tube	: Black fuel resistant nitrile rubber.
Temperature	: -40C to +120C(-40F to +250F)

Nom. I.D	Nom. O.D	PSI	Weight (lbs)	Std Pack Qty	Part #
3/16"	0.43"	75	0.08	300'	FUEL-019
1/4"	0.49"	50	0.09	300'	FUEL-025
5/16"	0.58"	50	0.12	300'	FUEL-031
3/8"	0.63"	50	0.13	300'	FUEL-038

Cut Lengths : Plus 5%

Standard Lengths : 300' coils

Recommended Couplings : Barbed short shank, combination nipples

Air and General Purpose Hose

Water Suction and Discharge Hose

Petroleum, Steam and Chemical Hose

Rubber Material Handling Hose

Plastic Material Handling Hose

Food Hose

Ducting

Auto Truck and Marine Hose

Fire Hose

Welding and Other Hose

Cam and Groove

Nipples and Shank Fittings

Clamps

High Pressure Fittings

Mine Fittings

Air Fittings

Valves

Sandblast

Fire Fittings

Pipe Fittings

Sheet Rubber

Index and Technical Information

Air and General Purpose Hose

Water Suction and Discharge Hose

Petroleum, Steam and Chemical Hose

Rubber Material Handling Hose

Plastic Material Handling Hose

Food Hose

Ducting

Auto Truck and Marine Hose

Fire Hose

Welding and Other Hose

Cam and Groove

Nipples Menders and Shank Fittings

Clamps

High Pressure Fittings

Mine Fittings

Air Fittings

Valves

Sandblast

Fire Fittings

Pipe Fittings

Sheet Rubber

Index and Technical Information

SILICONE COOLANT HOSE



- Application** : Truck and bus fleets and other areas where long service life under high temperature conditions is required.
- Cover** : Blue heat and weather resistant silicone with wrapped impression finish.
- Reinforcement** : Multiple plies of polyester fabric.
- Tube** : Red heat resistant silicone.
- Temperature** : -54C to +177C(-65F to +350F)

	Nom. I.D	Nom. O.D	PSI	Weight (lbs)	Std Pack Qty	Part #
	3/8"	0.75"	110	0.20	12'	SILC-038
	1/2"	0.88"	110	0.25	12'	SILC-050
	5/8"	1.00"	110	0.30	12'	SILC-063
	3/4"	1.13"	110	0.33	12'	SILC-075
	7/8"	1.26"	110	0.40	12'	SILC-088
	1"	1.38"	90	0.43	12'	SILC-100
	1-1/16"	1.44"	90	0.45	12'	SILC-106
	1-1/8"	1.51"	90	0.47	12'	SILC-113
	1-1/4"	1.63"	85	0.53	12'	SILC-125
	1-5/16"	1.69"	85	0.55	12'	SILC-131
	1-3/8"	1.76"	85	0.58	12'	SILC-138
	1-1/2"	1.88"	80	0.60	12'	SILC-150
	1-5/8"	2.00"	80	0.60	12'	SILC-163
	1-3/4"	2.13"	80	0.68	12'	SILC-175
	1-7/8"	2.26"	80	0.68	12'	SILC-187
	2"	2.38"	75	0.78	12'	SILC-200
	2-1/8"	2.50"	75	0.87	12'	SILC-213
	2-1/4"	2.63"	65	0.87	12'	SILC-225
	2-3/8"	2.76"	65	0.90	12'	SILC-238
	2-1/2"	2.88"	65	0.93	12'	SILC-250
	2-5/8"	3.00"	60	1.00	12'	SILC-263
	2-3/4"	3.13"	50	1.03	12'	SILC-275
	3"	3.38"	50	1.13	12'	SILC-300
	3-1/2"	3.88"	35	1.37	12'	SILC-350
	4"	4.38"	35	1.53	12'	SILC-400
	4-1/2"	4.88"	25	1.68	12'	SILC-450
	5"	5.38"	25	1.88	12'	SILC-500
	5-1/2"	5.88"	20	2.13	12'	SILC-550
	6"	6.38"	20	2.20	12'	SILC-600

Cut Lengths : No Cut Lengths

Standard Lengths : 4'/12'

Recommended Couplings : Cam and groove, combination nipples

SILICONE HEATER HOSE



- Application** : Truck and bus fleets and other areas where long service life under high temperature conditions is required.
- Cover** : Blue heat and weather resistant silicone.
- Reinforcement** : Multiple plies of polyester fabric.
- Tube** : Red heat resistant silicone.
- Temperature** : -54C to +177C(-65F to +350F)

Nom. I.D	Nom. O.D	PSI	Weight (lbs)	Std Pack Qty	Part #
1/4"	0.50"	75	0.08	250'	SILH-025
5/16"	0.58"	65	0.06	250'	SILH-031
3/8"	0.66"	65	0.10	250'	SILH-038
1/2"	0.80"	65	0.15	250	SILH-050
5/8"	0.97"	65	0.25	250'	SILH-063
3/4"	1.13"	50	0.30	250'	SILH-075
1"	1.42"	45	0.45	100'	SILH-100

Cut Lengths : Plus 5%

Standard Lengths : 25'/50' or reels.

Recommended Couplings : Barbed short shank, combination nipples

AUTO HEATER



- Application** : For use in general industrial and automotive service
- Cover** : Black heat and weather resistant EPDM rubber.
- Reinforcement** : Two layers of synthetic yarns.
- Tube** : Black heat resistant EPDM synthetic rubber. Resistant to anti-freeze solutions.
- Temperature** : -35C to +105C(-30F to +220F)

Nom. I.D	Nom. O.D	PSI	Weight (lbs)	Std Pack Qty	Part #
1/2"	0.79"	60	0.20	300'	AUTO-050
5/8"	0.91"	60	0.23	300'	AUTO-063
3/4"	1.06"	50	0.37	300'	AUTO-075
1"	1.38"	50	0.51	300'	AUTO-100

Cut Lengths : Plus 10%

Standard Lengths : 50'/300' coils

Recommended Couplings : Barbed short shank, combination nipples

Air and General Purpose Hose

Water Suction and Discharge Hose

Petroleum, Steam and Chemical Hose

Rubber Material Handling Hose

Plastic Material Handling Hose

Food Hose

Ducting

Auto Truck and Marine Hose

Fire Hose

Welding and Other Hose

Cam and Groove

Nipples Menders and Shank Fittings

Clamps

High Pressure Fittings

Mine Fittings

Air Fittings

Valves

Sandblast

Fire Fittings

Pipe Fittings

Sheet Rubber

Index and Technical Information

GARAGE EXHAUST HOSE

Air and General Purpose Hose

Water Suction and Discharge Hose

Petroleum, Steam and Chemical Hose

Rubber Material Handling Hose

Plastic Material Handling Hose

Food Hose

Ducting

Auto Truck and Marine Hose

Fire Hose

Welding and Other Hose

Cam and Groove

Nipples, Menders and Shank Fittings

Clamps

High Pressure Fittings

Mine Fittings

Air Fittings

Valves

Sandblast

Fire Fittings

Pipe Fittings

Sheet Rubber

Index and Technical Information



Application

: Garage Exhaust hose is manufactured in 11' lengths. An all rubber construction results in a crush-proof product. Heat resistant EPDM rubber resists high temperature of exhaust emissions. An exclusive patented design allows you to splice, connect and re-connect as needed.

Cover Temperature

: High Temperature EPDM
: up to 400F(600F Intermittent)

Description	Weight (lbs)	Part #
2" X11' GARAGE EXHAUST	7.00	GXC-200
2-1/2"X11' GARAGE EXHAUST	7.00	GXC-250
3"X11' GARAGE EXHAUST	9.40	GXC-300
4"X11' GARAGE EXHAUST	16.00	GXC-400
5"X11' GARAGE EXHAUST	21.00	GXC-500
DOOR PORT	1.08	GXC-DP
3" DOOR PORT	1.30	GXC-DP3
UNIVERSAL ADAPTER	1.42	GXC-UA
Y-ADAPTER ALUMINUM 2-1/2"	4.00	GXC-YA
Y-ADAPTER RUBBER 3"	2.00	GXC-YR
Y-ADAPTER ALUMINUM 4"	4.25	GXC-YA4
DUAL EXHAUST ADAPTER	1.66	GXC-DX
DIESEL ELBOW ADAPTER	6.00	GXC-DE
5" DIESEL STACK ADAPTER RUBBER	5.00	GXC-DS5

Standard Lengths : 11'

ARMTEX RUBBER COVERED FM APPROVED, ULC LISTED



- Application** : Professional and general firefighting service. FM approval ensures your fire insurance requirements are met.
- Cover** : Red oil and weather resistant nitrile rubber, ribbed.
- Reinforcement** : High tenacity woven polyester jacket.
- Tube** : Red oil resistant nitrile rubber.
- Temperature** : -20C to +80C(0F to +180F)

Nom. I.D	Bowl Size	Test PSI	Service PSI	Weight (lbs)	Part #
1-1/2"	1-3/4"	600	300	0.22	ARM-150
1-3/4"	2"	600	300	0.26	ARM-175
2"	2-1/4"	500	250	0.30	ARM-200
2-1/2"	2-3/4"	500	250	0.40	ARM-250
3"	3-5/16"	400	200	0.47	ARM-300

Cut Lengths : P.O.A
Standard Lengths : 50'/100'
Product Information : 1-1/2", 2-1/2" FM Approved, ULC Listed
Recommended Couplings : Fire hose expansion ring

ARMTEX HD RUBBER COVERED ULC LISTED



- Application** : Professional and general firefighting service. ULC listing ensures your fire insurance requirements are met.
- Reinforcement** : High tenacity woven polyester jacket.
- Cover** : Red oil and weather resistant nitrile rubber, double ribbed.
- Tube** : Red oil resistant nitrile rubber.
- Temperature** : -20C to +80C(0F to +180F)

Nom. I.D	Bowl Size	Test PSI	Service PSI	Weight (lbs)	Part #
1-1/2"	1-3/4"	600	300	0.32	ARHD-150
1-3/4"	2"	600	300	0.36	ARHD-175
2"	2-1/4"	600	300	0.40	ARHD-200
2-1/2"	2-3/4"	600	300	0.50	ARHD-250
3"	3-3/8"	400	200	0.60	ARHD-300
4"	N/A	400	200	0.80	ARHD-400
5"	N/A	400	200	1.10	ARHD-500
6"	N/A	400	200	1.20	ARHD-600

Cut Lengths : P.O.A
Standard Lengths : 50'/100'
Product Information : 1-1/2", 1-3/4", 2-1/2" ULC Listed
Product Information : Note: 4" and 5" Armtex HD has a yellow cover
Recommended Couplings : Fire hose expansion ring

- Air and General Purpose Hose
- Water Suction and Discharge Hose
- Petroleum, Steam and Chemical Hose
- Rubber Material Handling Hose
- Plastic Material Handling Hose
- Food Hose
- Ducting
- Auto Truck and Marine Hose
- Fire Hose
- Welding and Other Hose
- Cam and Groove
- Nipples Menders and Shank Fittings
- Clamps
- High Pressure Fittings
- Mine Fittings
- Air Fittings
- Valves
- Sandblast
- Fire Fittings
- Pipe Fittings
- Sheet Rubber
- Index and Technical Information

Air and General Purpose Hose

DOUBLE JACKET 800 PSI



Water Suction and Discharge Hose

Application : Municipal fire fighting service and heavy duty industrial applications.

Cover : Two circular woven all polyester jackets for good abrasion resistance.

Tube : Smooth synthetic rubber.

Temperature : -35C to +80C(-30F to +180F)

Petroleum, Steam and Chemical Hose

	Nom. I.D	Bowl Size	Test PSI	Service PSI	Weight (lbs)	Std Pack Qty	Part #
Rubber Material Handling Hose	1-1/2"	1-15/16"	800	400	0.36	100'	DJ8-150
	1-3/4"	2-5/32"	800	400	0.42	100'	DJ8-175
Plastic Material Handling Hose	2"	2-1/2"	800	400	0.48	100'	DJ8-200
	2-1/2"	3"	800	400	0.64	100'	DJ8-250
Food Hose	3"	3-9/16"	800	400	0.82	100'	DJ8-300

Standard Lengths : 50'/100'

Product Information : 1-1/2", 2-1/2" U.L. Listed

Recommended Couplings : Fire hose expansion ring

Ducting

Auto Truck and Marine Hose

DOUBLE JACKET 800 PSI HYPALON



Fire Hose

Welding and Other Hose

Application : Municipal fire fighting service and heavy duty industrial applications.

Cover : Yellow Hypalon impregnated all polyester circular woven outer jacket. All polyester circular woven inner jacket.

Tube : Smooth synthetic rubber.

Temperature : -35C to +80C(-30F to +180F)

Cam and Groove

Nipples, Menders and Shank Fittings

	Nom. I.D	Bowl Size	Test PSI	Service PSI	Weight (lbs)	Std Pack Qty	Part #
Clamps	1-1/2"	1-15/16"	800	400	0.38	100'	DJ8H-150
High Pressure Fittings	1-3/4"	2-5/32"	800	400	0.44	100'	DJ8H-175
	2"	2-1/2"	800	400	0.50	100'	DJ8H-200
Mine Fittings	2-1/2"	3"	800	400	0.66	100'	DJ8H-250
Air Fittings	3"	3-9/16"	800	400	0.86	100'	DJ8H-300

Standard Lengths : 50'/100'

Product Information : 1-1/2", 2-1/2" U.L. Listed

Recommended Couplings : Fire hose expansion ring

Valves

Sandblast

Fire Fittings

Pipe Fittings

Sheet Rubber

Index and Technical Information

SINGLE JACKET RUBBER LINED 500 PSI



- Application** : An approved hose for light duty fire protection.
Cover : All polyester circular woven jacket with good abrasion resistance.
Tube : Smooth synthetic rubber.
Temperature : -35C to +80C(-30F to +180F)

Nom. I.D	Bowl Size	Test PSI	Service PSI	Weight (lbs)	Std Pack Qty	Part #
1-1/2"	1-3/4"	500	250	0.26	100'	SJ5-150
1-3/4"	1-15/16"	500	250	0.38	100'	SJ5-175
2"	2-3/8"	500	250	0.42	100'	SJ5-200
2-1/2"	2-3/4"	500	250	0.48	100'	SJ5-250
3"	3-3/8"	500	250	0.62	100'	SJ5-300

Standard Lengths : 50'/100'

Product Information : 1-1/2", 2-1/2" U.L. Listed

Recommended Couplings : Fire hose expansion ring

SINGLE JACKET INDUSTRIAL MILL



- Application** : General industrial service where approved fire hose is not required.
Cover : All polyester circular woven jacket with good abrasion resistance.
Tube : Smooth synthetic rubber.
Temperature : -35C to +80C(-30F to +180F)

Nom. I.D	Bowl Size	Weight (lbs)	Std Pack Qty	Part #
1-1/2"	1-3/4"	0.26	100'	SJM-150
2"	2-3/8"	0.42	100'	SJM-200
2-1/2"	2-3/4"	0.48	100'	SJM-250
3"	3-3/8"	0.54	100'	SJM-300

Cut Lengths : P.O.A

Standard Lengths : 50'/100'

Recommended Couplings : Fire hose expansion ring

Air and General Purpose Hose

Water Suction and Discharge Hose

Petroleum, Steam and Chemical Hose

Rubber Material Handling Hose

Plastic Material Handling Hose

Food Hose

Ducting

Auto Truck and Marine Hose

Fire Hose

Welding and Other Hose

Cam and Groove

Nipples and Shank Fittings

Clamps

High Pressure Fittings

Mine Fittings

Air Fittings

Valves

Sandblast

Fire Fittings

Pipe Fittings

Sheet Rubber

Index and Technical Information

Air and General Purpose Hose

Water Suction and Discharge Hose

Petroleum, Steam and Chemical Hose

Rubber Material Handling Hose

Plastic Material Handling Hose

Food Hose

Ducting

Auto Truck and Marine Hose

Fire Hose

Welding and Other Hose

Cam and Groove

Nipples, Menders and Shank Fittings

Clamps

High Pressure Fittings

Mine Fittings

Air Fittings

Valves

Sandblast

Fire Fittings

Pipe Fittings

Sheet Rubber

Index and Technical Information

DURAFLO BLUE (RUBBER COVERED STANDPIPE WASHDOWN)



- Application** : Standpipe washdown service in refineries and paper mills.
- Cover** : Blue oil and weather resistant nitrile rubber.
- Reinforcement** : High tenacity woven polyester jacket.
- Tube** : Blue oil resistant nitrile rubber.
- Temperature** : -20C to +80C(0F to +180F)

Nom. I.D	Bowl Size	Test PSI	Service PSI	Weight (lbs)	Std Pack Qty	Part #
1-1/2"	1-11/16"	400	200	0.18	100'	DUR-150

Cut Lengths : P.O.A
Standard Lengths : 50'/100'
Recommended Couplings : Fire hose expansion ring

RACK HOSE



- Application** : General industrial service where approved fire hose is not required.
- Cover** : All polyester circular woven jacket with good abrasion resistance.
- Tube** : Polyurethane lined

Nom. I.D	Bowl Size	Weight (lbs)	Std Pack Qty	Part #
1-1/2"	1-11/16"	0.13	50'	RACK
1-1/2"	1-11/16"	0.13	75'	RACK-75
1-1/2"	1-11/16"	0.13	100'	RACK-100

Cut Lengths : P.O.A
Standard Lengths : 50'/100'
Recommended Couplings : Fire hose expansion ring

PRESSURE WASHER



- Application** : For use with pressure wash equipment up to temperatures of 100C (212F) for 3,000PSI and 120C (250F) for 4,500PSI. Not suitable for live steam service.
- Cover** : Black or Blue abrasion, heat, and oil resistant synthetic rubber.
- Reinforcement** : One (3,000PSI) or Two wire braid (4,500PSI)
- Tube** : Black heat resistant nitrile rubber.
- Temperature** : -40C to +120C(-40F to +248F)

Nom. I.D	Nom. O.D	PSI	Weight (lbs)	Std Pack Qty	Part #
3/8"	0.64"	3000	0.30	300'	PWB-038
3/8"	0.64"	3000	0.30	300'	PWBL-038
3/8"	0.75"	4500	0.33	100'	PWHPB-038

Cut Lengths : Plus 5%

Standard Lengths : Approx 300' coils

Recommended Couplings : Hydraulic crimp type

PAINT SPRAY



- Application** : For use with low pressure spray guns, and agricultural chemicals. Suitable for conveying the following solvents. Acetone, alcohols, Butyl Cellosolve, Ethyl Acetate, M.E.K., M.I.B.K.,
- Cover** : Black weather, oil and chemical resistant thermoplastic rubber.
- Reinforcement** : Multiple layers of synthetic yarns.
- Tube** : Polyethylene for good solvent and chemical resistance.
- Temperature** : -40C to +52C(-40F to +125F)

Nom. I.D	Nom. O.D	PSI	Weight (lbs)	Std Pack Qty	Part #
1/4"	0.50"	175	0.07	500'	PAINT-025-175
3/8"	0.68"	175	0.12	500'	PAINT-038-175
1/2"	0.88"	175	0.19	500'	PAINT-050-175

Cut Lengths : Plus 10%

Standard Lengths : 500' reels

Safety Information : W.P. ratings are based on 20C (68C). At operating temperature of +50C (122F) reduce W.P. by 50%.

Recommended Couplings : Crimp on, combination nipples

Air and
General
Purpose
Hose

PAINT SPRAY NYLON

Water
Suction
and
Discharge
Hose



Petroleum,
Steam and
Chemical
Hose

Application : For use with hot spray, airless spray guns, application of adhesives and agricultural chemicals.

Cover : Black weather, oil and chemical resistant Neoprene.

Reinforcement : Multiple layers of synthetic yarns.

Tube : Nylon for good solvent and chemical resistance.

Temperature : -18C to +65C(0F to +150F)

Rubber
Material
Handling
Hose

Nom. I.D	Nom. O.D	PSI	Weight (lbs)	Std Pack Qty	Part #
1/4"	0.55"	750	0.11	500'	PAINT-025
3/8"	0.69"	750	0.18	500'	PAINT-038
1/2"	0.88"	750	0.30	500'	PAINT-050

Plastic
Material
Handling
Hose

Cut Lengths : Plus 10%

Standard Lengths : 500' reels

Recommended Couplings : High pressure or hydraulic crimp type

Food Hose

Ducting

Auto
Truck and
Marine
Hose

Fire Hose

Welding
and
Other Hose

Cam
and
Groove

Nipples
Menders
and
Shank
Fittings

Clamps

High
Pressure
Fittings

Mine
Fittings

Air
Fittings

Valves

Sandblast

Fire
Fittings

Pipe
Fittings

Sheet
Rubber

Index
and
Technical
Information

SINGLE LINE WELDING TYPE S GRADE R



Application	: Welding gas service. Hose meets R.M.A.- Compressed Gas Association Type S Grade R specifications.
Cover	: Ribbed heat and abrasion resistant synthetic rubber. Green for oxygen, Red for acetylene.
Reinforcement Tube	: Multiple layers of high tensile synthetic yarns. : Smooth black synthetic rubber.
Temperature	: -40C to +95C(-40F to +200F)

Nom. I.D	Nom. O.D	PSI	Weight (lbs)	Std Pack Qty	Part #
3/16"	0.44"	200	0.14	700'	SW-019-G
3/16"	0.44"	200	0.14	700'	SW-019-R
1/4"	0.53"	200	0.19	700'	SW-025-G
1/4"	0.53"	200	0.19	700'	SW-025-R
5/16"	0.59"	200	0.21	700'	SW-031-G
5/16"	0.59"	200	0.21	700'	SW-031-R
3/8"	0.65"	200	0.28	700'	SW-038-G
3/8"	0.65"	200	0.28	700'	SW-038-R

Cut Lengths : Plus 5%

Standard Lengths : 50'/700' reels

Recommended Couplings : Welding stem and nut all above items

TWIN WELDING TYPE VD GRADE R ASSEMBLY



Application	: Welding gas service. Hose meets R.M.A.- Compressed Gas Association Type VD Grade R specification. Two lines are bonded together. Ends may be separated without tearing cover.
Cover	: Smooth heat and abrasion resistant synthetic rubber. Green for oxygen, Red for acetylene.
Reinforcement Tube	: Multiple layers of high tensile synthetic yarns. : Smooth black synthetic rubber.
Temperature	: -40C to +95C(-40F to +200F)

Nom. I.D	Nom. O.D	PSI	Weight (lbs)	Part #
1/4"	0.53"	200	19.44	TW-025-100ASS
1/4"	0.53"	200	9.94	TW-025-50ASS

Cut Lengths : Plus 5%

Standard Lengths : Assemblies

Recommended Couplings : Welding stem and nut all above items

Air and General Purpose Hose

Water Suction and Discharge Hose

Petroleum, Steam and Chemical Hose

Rubber Material Handling Hose

Plastic Material Handling Hose

Food Hose

Ducting

Auto Truck and Marine Hose

Fire Hose

Welding and Other Hose

Cam and Groove

Nipples and Shank Fittings

Clamps

High Pressure Fittings

Mine Fittings

Air Fittings

Valves

Sandblast

Fire Fittings

Pipe Fittings

Sheet Rubber

Index and Technical Information

Air and General Purpose Hose

SINGLE LINE WELDING TYPE S GRADE RM



Water Suction and Discharge Hose

Application : Welding gas service. Hose meets R.M.A.- Compressed Gas Association Type S Grade RM specifications.

Petroleum, Steam and Chemical Hose

Cover : Ribbed heat and abrasion resistant synthetic rubber. Green for oxygen, Red for acetylene.

Rubber Material Handling Hose

Reinforcement Tube : Multiple layers of high tensile synthetic yarns.

Tube : Smooth black synthetic rubber.

Temperature : -40C to +95C(-40F to +200F)

Plastic Material Handling Hose

	Nom. I.D	Nom. O.D	PSI	Weight (lbs)	Std Pack Qty	Part #
	3/16"	0.44"	200	0.14	700'	SWRM-019-G
	3/16"	0.44"	200	0.14	700'	SWRM-019-R
	1/4"	0.53"	200	0.19	700'	SWRM-025-G
Food Hose	1/4"	0.53"	200	0.19	700'	SWRM-025-R
Ducting	3/8"	0.65"	200	0.28	700'	SWRM-038-G
Auto Truck and Marine Hose	3/8"	0.65"	200	0.28	700'	SWRM-038-R

Food Hose

Cut Lengths : Plus 5%

Standard Lengths : 50'/700' reels

Recommended Couplings : Welding stem and nut all above items

Ducting

Auto Truck and Marine Hose

Fire Hose

TWIN WELDING TYPE VD GRADE R



Welding and Other Hose

Cam and Groove

Application : Welding gas service. Hose meets R.M.A.- Compressed Gas Association Type VD Grade R specification. Two lines are bonded together. Ends may be separated without tearing cover.

Nipples Menders and Shank Fittings

Cover : Smooth heat and abrasion resistant synthetic rubber. Green for oxygen, Red for acetylene.

Clamps

Reinforcement Tube : Multiple layers of high tensile synthetic yarns.

High Pressure Fittings

Tube : Smooth black synthetic rubber.

Temperature : -40C to +95C(-40F to +200F)

Mine Fittings

	Nom. I.D	Nom. O.D	PSI	Weight (lbs)	Std Pack Qty	Part #
	3/16"	0.44"	200	0.14	700'	TW-019
	1/4"	0.53"	200	0.19	700'	TW-025
	5/16"	0.59"	200	0.21	700'	TW-031
Sandblast	3/8"	0.65"	200	0.28	700'	TW-038

Air Fittings

Valves

Sandblast

Cut Lengths : Plus 5%

Standard Lengths : 50'/700' reels

Recommended Couplings : Welding stem and nut all above items

Fire Fittings

Pipe Fittings

Sheet Rubber

Index and Technical Information

TWIN WELDING TYPE VD GRADE RM



- Application** : Welding gas service. Hose meets R.M.A.- Compressed Gas Association Type VD Grade RM specification. Two lines are bonded together. Ends may be separated without tearing cover.
- Cover** : Smooth heat and abrasion resistant synthetic rubber. Green for oxygen, Red for acetylene.
- Reinforcement Tube** : Multiple layers of high tensile synthetic yarns.
: Smooth black synthetic rubber.
- Temperature** : -40C to +95C(-40F to +200F)

Nom. I.D	Nom. O.D	PSI	Weight (lbs)	Std Pack Qty	Part #
3/16"	0.44"	200	0.14	700'	TWRM-019
1/4"	0.53"	200	0.19	700'	TWRM-025
5/16"	0.59"	200	0.21	700'	TWRM-031
3/8"	0.65"	200	0.28	700'	TWRM-038

Cut Lengths : Plus 5%

Standard Lengths : 50'/700' reels

Recommended Couplings : Welding stem and nut all above items

Air and General Purpose Hose

Water Suction and Discharge Hose

Petroleum, Steam and Chemical Hose

Rubber Material Handling Hose

Plastic Material Handling Hose

Food Hose

Ducting

Auto Truck and Marine Hose

Fire Hose

Welding and Other Hose

Cam and Groove

Nipples, Menders and Shank Fittings

Clamps

High Pressure Fittings

Mine Fittings

Air Fittings

Valves

Sandblast

Fire Fittings

Pipe Fittings

Sheet Rubber

Index and Technical Information

Safety Information : NOT FOR USE WITH COMPRESSED GASES

PART A ALUMINUM

Casting Temp. : -101C to +121C(-150F to +250F)

	Size	Weight (lbs)	Std Pack Qty	Part #
 <p>MALE ADAPTER</p> <p>FEMALE NPT</p>	1/2"	0.06	100	CGA-050-A1
	3/4"	0.13	50	CGA-075-A1
	1"	0.15	50	CGA-100-A1
	1-1/4"	0.29	50	CGA-125-A1
	1-1/2"	0.29	50	CGA-150-A1
	2"	0.39	50	CGA-200-A1
	2-1/2"	0.53	20	CGA-250-A1
	3"	0.72	20	CGA-300-A1
	4"	1.26	10	CGA-400-A1
	5"	1.48	2	CGA-500-A1
	6"	2.20	2	CGA-600-A1
	8"	6.61	3	CGA-800-A1
	10"	9.20	2	CGA-1000-A

PART A STAINLESS 316

Casting Temp. : -101C to +260C(-150F to +500F)

Size	Weight (lbs)	Std Pack Qty	Part #
1/2"	0.13	100	CGA-050-SS1
3/4"	0.31	50	CGA-075-SS1
1"	0.37	50	CGA-100-SS1
1-1/4"	0.48	50	CGA-125-SS1
1-1/2"	0.75	50	CGA-150-SS1
2"	0.94	50	CGA-200-SS1
2-1/2"	1.54	20	CGA-250-SS1
3"	1.75	20	CGA-300-SS1
4"	3.73	10	CGA-400-SS1
5"	4.41	2	CGA-500-SS1
6"	7.34	2	CGA-600-SS1
8"	13.22	3	CGA-800-SS1

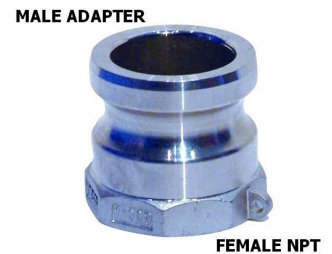

Air and General Purpose Hose

Water Suction and Discharge Hose

Petroleum, Steam and Chemical Hose

Rubber Material Handling Hose

Plastic Material Handling Hose

Food Hose

Ducting

Auto Truck and Marine Hose

Fire Hose

Welding and Other Hose

Cam and Groove

Nipples Menders and Shank Fittings

Clamps

High Pressure Fittings

Mine Fittings

Air Fittings

Valves

Sandblast

Fire Fittings

Pipe Fittings

Sheet Rubber

Index and Technical Information

Air and General Purpose Hose

PART A BRASS

Casting Temp. : -101C to +232C(-150F to +450F)

Water Suction and Discharge Hose

Petroleum, Steam and Chemical Hose

Rubber Material Handling Hose

Plastic Material Handling Hose

Food Hose

Ducting

Auto Truck and Marine Hose

Fire Hose

Welding and Other Hose

Cam and Groove

Nipples, Menders and Shank Fittings

Clamps

High Pressure Fittings

Mine Fittings

Air Fittings

Valves

Sandblast

Fire Fittings

Pipe Fittings

Sheet Rubber

Index and Technical Information

MALE ADAPTER



FEMALE NPT

Size	Weight (lbs)	Std Pack Qty	Part #
1/2"	0.21	100	CGA-050-B1
3/4"	0.42	100	CGA-075-B1
1"	0.50	60	CGA-100-B1
1-1/4"	0.68	60	CGA-125-B1
1-1/2"	0.80	60	CGA-150-B1
2"	0.89	40	CGA-200-B1
2-1/2"	1.88	30	CGA-250-B1
3"	1.68	30	CGA-300-B1
4"	3.25	12	CGA-400-B1
5"	5.65	6	CGA-500-B1
6"	6.71	6	CGA-600-B1

PART A DUCTILE IRON

Casting Temp. : -29C to +260C(-20F to +500F)

Size	Weight (lbs)	Std Pack Qty	Part #
1/2"	0.19	100	CGA-050-DP
3/4"	0.40	100	CGA-075-DP
1"	0.47	60	CGA-100-DP
1-1/4"	0.65	60	CGA-125-DP
1-1/2"	0.73	60	CGA-150-DP
2"	0.86	40	CGA-200-DP
3"	1.60	30	CGA-300-DP
4"	2.93	12	CGA-400-DP
6"	5.70	6	CGA-600-DP

MALE ADAPTER



FEMALE NPT

PART A POLY

Casting Temp. : -26C to +66C(-15F to +150F)

MALE ADAPTER



FEMALE NPT

Size	Weight (lbs)	Std Pack Qty	Part #
1/2"	0.03	100	CGA-050-PP
3/4"	0.04	50	CGA-075-PP
1"	0.04	50	CGA-100-PP
1-1/4"	0.15	50	CGA-125-PP
1-1/2"	0.18	50	CGA-150-PP
2"	0.24	50	CGA-200-PP
3"	0.65	20	CGA-300-PP
4"	0.90	10	CGA-400-PP

PART A NYLON GLASS

Casting Temp. : -34C to +121C(-30F to +250F)

Size	Weight (lbs)	Std Pack Qty	Part #
1/2"	0.04	100	CGA-050-NY
3/4"	0.04	50	CGA-075-NY
1"	0.04	50	CGA-100-NY
1-1/4"	0.15	50	CGA-125-NY
1-1/2"	0.14	50	CGA-150-NY
2"	0.25	50	CGA-200-NY
3"	0.40	20	CGA-300-NY
4"	0.90	10	CGA-400-NY

MALE ADAPTER



FEMALE NPT

Air and General Purpose Hose

Water Suction and Discharge Hose

Petroleum, Steam and Chemical Hose

Rubber Material Handling Hose

Plastic Material Handling Hose

Food Hose

Ducting

Auto Truck and Marine Hose

Fire Hose

Welding and Other Hose

Cam and Groove

Nipples, Menders and Shank Fittings

Clamps

High Pressure Fittings

Mine Fittings

Air Fittings

Valves

Sandblast

Fire Fittings

Pipe Fittings

Sheet Rubber

Index and Technical Information

PART A ALUMINUM BSP THREAD

Casting Temp. : -101C to +121C(-150F to +250F)

MALE ADAPTER



FEMALE BSP

Size	Weight (lbs)	Std Pack Qty	Part #
1-1/2"	0.26	50	CGABSP-150-A1
2"	0.39	50	CGABSP-200-A1
3"	0.72	20	CGABSP-300-A1
4"	1.26	10	CGABSP-400-A1
6"	2.20	2	CGABSP-600-A1

PART A STAINLESS 316 BSP THREAD

Casting Temp. : -101C to +260C(-150F to +500F)

Size	Weight (lbs)	Std Pack Qty	Part #
1"	0.37	50	CGABSP-100-SS1
1-1/2"	0.75	50	CGABSP-150-SS1
2"	0.94	50	CGABSP-200-SS1
3"	1.75	20	CGABSP-300-SS1
4"	3.73	10	CGABSP-400-SS1
6"	7.34	2	CGABSP-600-SS1

MALE ADAPTER



FEMALE BSP

Air and General Purpose Hose

Water Suction and Discharge Hose

Petroleum, Steam and Chemical Hose

Rubber Material Handling Hose

Plastic Material Handling Hose

Food Hose

Ducting

Auto Truck and Marine Hose

Fire Hose

Welding and Other Hose

Cam and Groove

Nipples, Menders and Shank Fittings

Clamps

High Pressure Fittings

Mine Fittings

Air Fittings

Valves

Sandblast

Fire Fittings

Pipe Fittings

Sheet Rubber

Index and Technical Information

PART A ALUMINUM NPS THREAD

Gasket Material : NBR
Gasket Temp. : -40C to +100C (-40F to +212F)
Casting Temp. : -101C to +121C (-150F to +250F)

MALE ADAPTER



FEMALE NPS

Size	Weight (lbs)	Std Pack Qty	Part #
2"	0.39	50	CGANPS-200-A
3"	0.72	20	CGANPS-300-A
4"	1.26	10	CGANPS-400-A
6"	2.20	2	CGANPS-600-A

PART A SPOOL ADAPTER ALUMINUM

Casting Temp. : -101C to +121C (-150F to +250F)

Description	Weight (lbs)	Part #
1" SPOOL ADAPTER ALUM	0.44	SA-100-A
1-1/2" SPOOL ADAPTER ALUM	0.55	SA-150-A
2" SPOOL ADAPTER ALUM	0.66	SA-200-A
2"X2-1/2" SPOOL ADAPTER ALUM	0.98	SA-2025-A
2"X3" SPOOL ADAPTER ALUM	1.10	SA-2030-A
2-1/2" SPOOL ADAPTER ALUM	1.03	SA-250-A
3" SPOOL ADAPTER ALUM	1.24	SA-300-A
3"X4" SPOOL ADAPTER ALUM	1.84	SA-3040-A
4" SPOOL ADAPTER ALUM	1.93	SA-400-A
4"x6" SPOOL ADAPTER ALUMINUM	3.58	SA-4060-A
6" SPOOL ADAPTER ALUM	4.41	SA-600-A

MALE ADAPTER



MALE ADAPTER

PART A SPOOL ADAPTER BRASS

Casting Temp. : -101C to +232C (-150F to +450F)

MALE ADAPTER



MALE ADAPTER

Description	Weight (lbs)	Part #
1-1/2" SPOOL ADAPTER BRASS	1.38	SA-150-B
2" SPOOL ADAPTER BRASS	2.09	SA-200-B
2-1/2" SPOOL ADAPTER BRASS	3.52	SA-250-B
3" SPOOL ADAPTER BRASS	3.67	SA-300-B
4" SPOOL ADAPTER BRASS	5.87	SA-400-B

PART A SPOOL ADAPTER STAINLESS 316

Casting Temp. : -101C to +260C(-150F to +500F)

Description	Weight (lbs)	Part #
3/4" SPOOL ADAPTER STAINLESS	0.53	SA-075-SS
1" SPOOL ADAPTER STAINLESS	0.98	SA-100-SS
1-1/4" SPOOL ADAPTER STAINLESS	1.80	SA-125-SS
1-1/2" SPOOL ADAPTER STAINLESS	2.09	SA-150-SS
1-1/2"X2" SPOOL ADAPTER STAINLESS	2.64	SA-1520-SS
2" SPOOL ADAPTER STAINLESS	3.00	SA-200-SS
2"X2-1/2" SPOOL ADAPTER STAINLESS	3.09	SA-2025-SS
2"X3" SPOOL ADAPTER STAINLESS	3.30	SA-2030-SS
2-1/2" SPOOL ADAPTER STAINLESS	3.15	SA-250-SS
3" SPOOL ADAPTER STAINLESS	4.41	SA-300-SS
3"X4" SPOOL ADAPTER STAINLESS	6.00	SA-3040-SS
4" SPOOL ADAPTER STAINLESS	8.00	SA-400-SS
4"X6" SPOOL ADAPTER STAINLESS	11.00	SA-4060-SS

MALE ADAPTER



MALE ADAPTER

Air and General Purpose Hose

Water Suction and Discharge Hose

Petroleum, Steam and Chemical Hose

Rubber Material Handling Hose

Plastic Material Handling Hose

Food Hose

Ducting

Auto Truck and Marine Hose

Fire Hose

Welding and Other Hose

Cam and Groove

Nipples Menders and Shank Fittings

Clamps

High Pressure Fittings

Mine Fittings

Air Fittings

Valves

Sandblast

Fire Fittings

Pipe Fittings

Sheet Rubber

Index and Technical Information

PART A REDUCER ADAPTER FEMALE NPT ALUMINUM

Casting Temp. : -101C to +121C(-150F to +250F)

Description	Weight (lbs)	Part #
1-1/2"X2"RED. ADAPTER/FEM NPT ALUM	0.44	CGA-1520-A
2"X1-1/2"RED. ADAPTER/FEM NPT ALUM	0.55	CGA-2015-A
2"X3"REDUCER ADAPTER/FEM NPT ALUM	0.83	CGA-2030-A
3"X2"REDUCER ADAPTER/FEM NPT ALUM	0.98	CGA-3020-A
3"X4"REDUCER ADAPTER/FEM NPT ALUM	1.43	CGA-3040-A
4"X3"REDUCER ADAPTER/FEM NPT ALUM	1.65	CGA-4030-A
4"X6"REDUCER ADAPTER/FEM NPT ALUM	2.76	CGA-4060-A
6"X4"REDUCER ADAPTER/FEM NPT ALUM	3.31	CGA-6040-A

FEMALE NPT



MALE ADAPTER

Product Information : First 2 numbers are the adapter size, second 2 numbers the thread or shank.

PART A NYLON REDUCER ADAPTER FEMALE NPT

Casting Temp. : -34C to +121C(-30F to +250F)

Description	Weight (lbs)	Part #
1-1/2"x1-1/4"NYLON RED.ADAP./FEM.NPT	0.17	CGA-1512-NY
1/2"x3/4"NYLON RED.ADAP./FEM.NPT	0.10	CGA-805-NY

FEMALE NPT



MALE ADAPTER

Air and General Purpose Hose

PART A POLY REDUCER ADAPTER FEMALE NPT

Casting Temp. : -26C to +66C(-15F to +150F)

FEMALE NPT



MALE ADAPTER

Description	Weight (lbs)	Part #
1-1/2"x1-1/4"POLY RED.ADAP./FEM.NPT	0.18	CGA-1512-PP
3/4"x1/2"POLY RED. ADAPTER/FEM.NPT	0.10	CGA-805-PP

Water Suction and Discharge Hose

Petroleum, Steam and Chemical Hose

Rubber Material Handling Hose

PART A POLY ELBOW 90 DEGREE

Casting Temp. : -26C to +66C(-15F to +150F)

Plastic Material Handling Hose

Description	Weight (lbs)	Part #
1-1/2"PART A 90 DEGREE POLY ELBOW	0.51	CGA-1590-PP
2"PART A 90 DEGREE POLY ELBOW	1.00	CGA-2090-PP

MALE ADAPTER



FEMALE NPT

Food Hose

Ducting

Auto Truck and Marine Hose

PART A ALUMINUM FLANGED CAMLOCK ADAPTER

Casting Temp. : -101C to +121C(-150F to +250F)

MALE ADAPTER



FLANGE

Size	Weight (lbs)	Std Pack Qty	Part #
2"	2.50	8	CGAF-200-A
3"	3.57	4	CGAF-300-A
4"	5.87	3	CGAF-400-A

Fire Hose

Welding and Other Hose

Cam and Groove

Nipples, Menders and Shank Fittings

Clamps

High Pressure Fittings

Mine Fittings

Air Fittings

Valves

Sandblast

Fire Fittings

Pipe Fittings

Sheet Rubber

Index and Technical Information

Safety Information : Working Temperature ratings are based on new cam and groove couplings at ambient temperatures. Used or worn couplings or extreme temperature conditions will result in reduced operating pressures. Not for use with compressed gases.

PART B ALUMINUM

Vacuum Rating : FULL
Gasket Material : NBR
Gasket Temp. : -40C to +100C(-40F to +212F)
Casting Temp. : -101C to +121C(-150F to +250F)

	Size	Max Operating PSI (70F)	Weight (lbs)	Std Pack Qty	Part #
	1/2"	250	0.15	100	CGB-050-A1
	3/4"	250	0.21	50	CGB-075-A1
	1"	250	0.39	50	CGB-100-A1
	1-1/4"	250	0.66	40	CGB-125-A1
	1-1/2"	250	0.70	40	CGB-150-A1
	2"	250	0.90	25	CGB-200-A1
	2-1/2"	150	1.05	18	CGB-250-A1
	3"	125	1.73	12	CGB-300-A1
	4"	100	2.49	8	CGB-400-A1
	5"	75	2.76	2	CGB-500-A1
	6"	75	4.63	2	CGB-600-A1
	8"	50	8.27	3	CGB-800-A1
	10"	50	13.20	1	CGB-1000-A

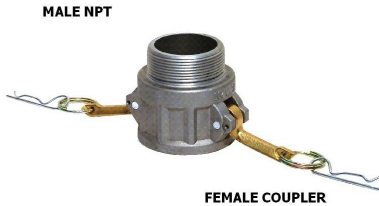

PART B DUCTILE IRON

Vacuum Rating : FULL
Gasket Material : NBR
Gasket Temp. : -40C to +100C(-40F to +212F)
Casting Temp. : -29C to +260C(-20F to +500F)

Size	Max Operating PSI (70F)	Weight (lbs)	Std Pack Qty	Part #
1/2"	250	0.29	100	CGB-050-DP
3/4"	250	0.46	50	CGB-075-DP
1"	250	0.80	60	CGB-100-DP
1-1/4"	250	1.10	40	CGB-125-DP
1-1/2"	250	1.13	40	CGB-150-DP
2"	250	1.40	24	CGB-200-DP
3"	100	2.90	12	CGB-300-DP
4"	100	4.00	7	CGB-400-DP

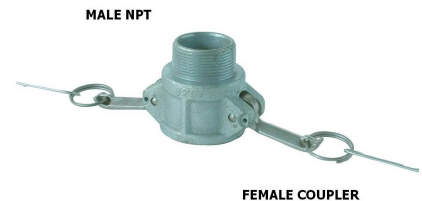

Air and General Purpose Hose

Water Suction and Discharge Hose

Petroleum, Steam and Chemical Hose

Rubber Material Handling Hose

Plastic Material Handling Hose

Food Hose

Ducting

Auto Truck and Marine Hose

Fire Hose

Welding and Other Hose

Cam and Groove

Nipples Menders and Shank Fittings

Clamps

High Pressure Fittings

Mine Fittings

Air Fittings

Valves

Sandblast

Fire Fittings

Pipe Fittings

Sheet Rubber

Index and Technical Information

Air and General Purpose Hose

Water Suction and Discharge Hose

Petroleum, Steam and Chemical Hose

Rubber Material Handling Hose

Plastic Material Handling Hose

Food Hose

Ducting

Auto Truck and Marine Hose

Fire Hose

Welding and Other Hose

Cam and Groove

Nipples, Menders and Shank Fittings

Clamps

High Pressure Fittings

Mine Fittings

Air Fittings

Valves

Sandblast

Fire Fittings

Pipe Fittings

Sheet Rubber

Index and Technical Information

PART B STAINLESS 316

Vacuum Rating : FULL
Gasket Material : NBR
Gasket Temp. : -40C to +100C(-40F to +212F)
Casting Temp. : -101C to +260C(-150F to +500F)

	Size	Max Operating PSI (70F)	Weight (lbs)	Std Pack Qty	Part #
	1/2"	250	0.46	100	CGB-050-SS1
	3/4"	250	0.48	50	CGB-075-SS1
	1"	250	0.77	50	CGB-100-SS1
	1-1/4"	250	1.17	40	CGB-125-SS1
	1-1/2"	250	1.24	40	CGB-150-SS1
	2"	250	1.73	25	CGB-200-SS1
	2-1/2"	200	2.29	18	CGB-250-SS1
	3"	200	3.15	12	CGB-300-SS1
	4"	100	4.23	8	CGB-400-SS1
	5"	75	6.98	2	CGB-500-SS1
	6"	75	11.01	2	CGB-600-SS1
	8"	50	20.00	2	CGB-800-SS1

PART B ALUMINUM WITH STAINLESS HANDLES

Vacuum Rating : FULL
Gasket Material : NBR
Gasket Temp. : -40C to +100C(-40F to +212F)
Casting Temp. : -101C to +121C(-150F to +250F)

	Size	Max Operating PSI (70F)	Weight (lbs)	Std Pack Qty	Part #
High Pressure Fittings	1/2"	250	0.15	100	CGB-050-A1S
	3/4"	250	0.22	50	CGB-075-A1S
Mine Fittings	1"	250	0.39	50	CGB-100-A1S
Air Fittings	1-1/4"	250	0.66	40	CGB-125-A1S
	1-1/2"	250	0.70	40	CGB-150-A1S
Valves	2"	250	0.90	25	CGB-200-A1S
	2-1/2"	150	1.05	18	CGB-250-A1S
Fire Fittings	3"	125	1.73	12	CGB-300-A1S
Pipe Fittings	4"	100	2.49	8	CGB-400-A1S
	5"	75	2.75	2	CGB-500-A1S
Sheet Rubber	6"	75	4.62	2	CGB-600-A1S



PART B BRASS

Vacuum Rating : FULL
Gasket Material : NBR
Gasket Temp. : -40C to +100C(-40F to +212F)
Casting Temp. : -101C to +232C(-150F to +450F)

	Size	Max Operating PSI (70F)	Weight (lbs)	Std Pack Qty	Part #
 <p>MALE NPT</p> <p>FEMALE COUPLER</p>	1/2"	250	0.30	100	CGB-050-B1
	3/4"	250	0.53	50	CGB-075-B1
	1"	250	0.88	60	CGB-100-B1
	1-1/4"	250	1.16	40	CGB-125-B1
	1-1/2"	250	1.19	40	CGB-150-B1
	2"	250	1.48	24	CGB-200-B1
	2-1/2"	150	2.12	24	CGB-250-B1
	3"	125	3.10	12	CGB-300-B1
	4"	100	4.14	10	CGB-400-B1
	5"	75	7.26	4	CGB-500-B1
6"	75	9.97	4	CGB-600-B1	

PART B POLY

Vacuum Rating : FULL
Gasket Material : EPDM
Gasket Temp. : -51C to +100C(-60F to +212F)
Casting Temp. : -26C to +66C(-15F to +150F)

Size	Max Operating PSI (70F)	Weight (lbs)	Std Pack Qty	Part #
1/2"	125	0.10	100	CGB-050-PP
3/4"	125	0.16	50	CGB-075-PP
1"	125	0.28	50	CGB-100-PP
1-1/4"	125	0.50	40	CGB-125-PP
1-1/2"	125	0.55	40	CGB-150-PP
2"	125	0.53	25	CGB-200-PP
3"	100	1.22	12	CGB-300-PP
4"	50	1.40	8	CGB-400-PP

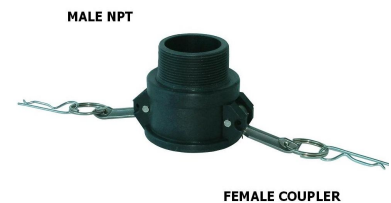

Air and General Purpose Hose

Water Suction and Discharge Hose

Petroleum, Steam and Chemical Hose

Rubber Material Handling Hose

Plastic Material Handling Hose

Food Hose

Ducting

Auto Truck and Marine Hose

Fire Hose

Welding and Other Hose

Cam and Groove

Nipples Menders and Shank Fittings

Clamps

High Pressure Fittings

Mine Fittings

Air Fittings

Valves

Sandblast

Fire Fittings

Pipe Fittings

Sheet Rubber

Index and Technical Information

Air and General Purpose Hose

Water Suction and Discharge Hose

Petroleum, Steam and Chemical Hose

Rubber Material Handling Hose

Plastic Material Handling Hose

Food Hose

Ducting

Auto Truck and Marine Hose

Fire Hose

Welding and Other Hose

Cam and Groove

Nipples, Menders and Shank Fittings

Clamps

High Pressure Fittings

Mine Fittings

Air Fittings

Valves

Sandblast

Fire Fittings

Pipe Fittings

Sheet Rubber

Index and Technical Information

PART B NYLON GLASS

Vacuum Rating : FULL
Gasket Material : EPDM
Gasket Temp. : -51C to +100C(-60F to +212F)
Casting Temp. : -34C to +121C(-30F to +250F)

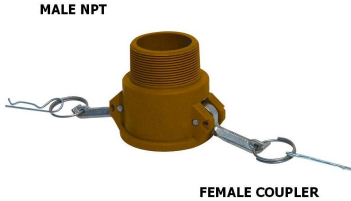
	Size	Max Operating PSI (70F)	Weight (lbs)	Std Pack Qty	Part #
 <p>MALE NPT</p> <p>FEMALE COUPLER</p>	1/2"	175	0.04	100	CGB-050-NY
	3/4"	175	0.16	50	CGB-075-NY
	1"	175	0.28	50	CGB-100-NY
	1-1/4"	150	0.48	40	CGB-125-NY
	1-1/2"	150	0.55	40	CGB-150-NY
	2"	150	0.45	25	CGB-200-NY
	3"	100	1.00	12	CGB-300-NY
	4"	50	1.30	8	CGB-400-NY

PART B ALUMINUM BSP THREAD

Vacuum Rating : FULL
Gasket Material : NBR
Gasket Temp. : -40C to +100C(-40F to +212F)
Casting Temp. : -101C to +121C(-150F to +250F)

Size	Max Operating PSI (70F)	Weight (lbs)	Std Pack Qty	Part #
1-1/2"	250	0.70	40	CGBBSP-150-A1
2"	250	0.90	25	CGBBSP-200-A1
3"	125	1.73	12	CGBBSP-300-A1
4"	100	2.49	8	CGBBSP-400-A1
6"	75	4.62	2	CGBBSP-600-A1

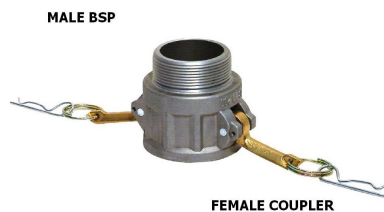

PART B STAINLESS 316 BSP THREAD

Vacuum Rating : FULL
Gasket Material : NBR
Gasket Temp. : -40C to +100C(-40F to +212F)
Casting Temp. : -101C to +260C(-150F to +500F)

	Size	Max Operating PSI (70F)	Weight (lbs)	Std Pack Qty	Part #
 <p>MALE BSP</p> <p>FEMALE COUPLER</p>	1"	250	0.77	50	CGBBSP-100-SS1
	1-1/2"	250	1.24	40	CGBBSP-150-SS1
	2"	250	1.73	25	CGBBSP-200-SS1
	3"	200	3.15	12	CGBBSP-300-SS1
	4"	100	4.23	8	CGBBSP-400-SS1

PART B NYLON REDUCER COUPLER MALE NPT

Vacuum Rating : FULL
Gasket Material : EPDM
Gasket Temp. : -51C to +100C(-60F to +212F)
Casting Temp. : -34C to +121C(-30F to +250F)

Description	Max Operating PSI (70F)	Part #
1-1/2"x1-1/4"NYLON RED.COUP./MALE NPT	175	CGB-1512-NY
3/4"x1/2" NYLON RED.COUP./MALE NPT	175	CGB-805-NY



PART B POLY REDUCER COUPLER MALE NPT

Vacuum Rating : FULL
Gasket Material : EPDM
Gasket Temp. : -51C to +100C(-60F to +212F)
Casting Temp. : -26C to +66C(-15F to +150F)

Description	Max Operating PSI (70F)	Part #
1-1/2"x1-1/4"POLY RED.COUP./MALE NPT	125	CGB-1512-PP
3/4"x1/2"POLY REDUCER COUPLER/MALE NPT	125	CGB-805-PP

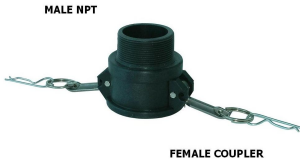

PART B REDUCER COUPLER MALE NPT ALUMINUM

Vacuum Rating : FULL
Gasket Material : NBR
Gasket Temp. : -40C to +100C(-40F to +212F)
Casting Temp. : -101C to +121C(-150F to +250F)

Description	Max Operating PSI (70F)	Part #
1-1/2"x1"REDUCER COUPLER/MALE NPT ALUM	250	CGB-1510-A
2"x1-1/2"REDUCER COUPLER/MALE NPT ALUM	250	CGB-2015-A
2"x3"REDUCER COUPLER/MALE NPT ALUM	250	CGB-2030-A
3"x2"REDUCER COUPLER/MALE NPT ALUM	125	CGB-3020-A
3"x4"REDUCER COUPLER/MALE NPT ALUM	125	CGB-3040-A
4"x3"REDUCER COUPLER/MALE NPT ALUM	100	CGB-4030-A
6"x4"REDUCER COUPLER/MALE NPT ALUM	75	CGB-6040-A

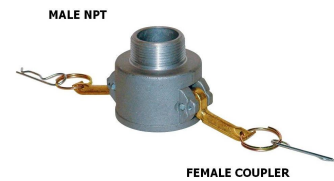

Air and General Purpose Hose

Water Suction and Discharge Hose

Petroleum, Steam and Chemical Hose

Rubber Material Handling Hose

Plastic Material Handling Hose

Food Hose

Ducting

Auto Truck and Marine Hose

Fire Hose

Welding and Other Hose

Cam and Groove

Nipples, Menders and Shank Fittings

Clamps

High Pressure Fittings

Mine Fittings

Air Fittings

Valves

Sandblast

Fire Fittings

Pipe Fittings

Sheet Rubber

Index and Technical Information

Air and General Purpose Hose

PART B ALUMINUM QUICKKLOK

Vacuum Rating : FULL
Gasket Material : NBR
Gasket Temp. : -40C to +100C(-40F to +212F)
Casting Temp. : -101C to +121C(-150F to +250F)

MALE NPT	Size	Max Operating PSI (70F)	Weight (lbs)	Std Pack Qty	Part #
 <p>FEMALE COUPLER</p>	1-1/2"	250	1.14	40	CGBHK-150-A1
	2"	250	1.34	25	CGBHK-200-A1
	2-1/2"	150	1.49	18	CGBHK-250-A1
	3"	125	2.39	12	CGBHK-300-A1
	4"	100	3.15	8	CGBHK-400-A1

Water Suction and Discharge Hose

Petroleum, Steam and Chemical Hose

Rubber Material Handling Hose

Plastic Material Handling Hose

Food Hose

PART B STAINLESS QUICKKLOK

Vacuum Rating : FULL
Gasket Material : NBR
Gasket Temp. : -40C to +100C(-40F to +212F)
Casting Temp. : -101C to +260C(-150F to +500F)

Size	Max Operating PSI (70F)	Weight (lbs)	Std Pack Qty	Part #
1"	250	0.72	40	CGBK-100-SS
1-1/2"	250	1.82	24	CGBK-150-SS
2"	250	2.37	24	CGBK-200-SS
2-1/2"	200	2.54	20	CGBK-250-SS
3"	200	4.16	12	CGBK-300-SS
4"	100	4.16	10	CGBK-400-SS

MALE NPT



FEMALE COUPLER

Ducting

Auto Truck and Marine Hose

Fire Hose

Welding and Other Hose

Cam and Groove

Nipples, Menders and Shank Fittings

Clamps

High Pressure Fittings

PART B BRASS QUICKKLOK

Vacuum Rating : FULL
Gasket Material : NBR
Gasket Temp. : -40C to +100C(-40F to +212F)
Casting Temp. : -101C to +232C(-150F to +450F)

MALE NPT	Size	Max Operating PSI (70F)	Weight (lbs)	Std Pack Qty	Part #
 <p>FEMALE COUPLER</p>	1-1/2"	250	1.19	40	CGBHK-150-B1
	2"	250	1.49	25	CGBHK-200-B1
	2-1/2"	150	2.13	18	CGBHK-250-B1
	3"	125	3.11	12	CGBHK-300-B1
	4"	100	4.80	8	CGBHK-400-B1

Mine Fittings

Air Fittings

Valves

Sandblast

Fire Fittings

Pipe Fittings

Sheet Rubber

Index and Technical Information

Safety Information : Working Temperature ratings are based on new cam and groove couplings at ambient temperatures. Used or worn couplings or extreme temperature conditions will result in reduced operating pressures. Not for use with compressed gases.

PART C ALUMINUM

Vacuum Rating : FULL
Gasket Material : NBR
Gasket Temp. : -40C to +100C(-40F to +212F)
Casting Temp. : -101C to +121C(-150F to +250F)

	Size	Max Operating PSI (70F)	Weight (lbs)	Std Pack Qty	Part #
	1/2"	250	0.10	100	CGC-050-A1
	3/4"	250	0.24	50	CGC-075-A1
	1"	250	0.44	50	CGC-100-A1
	1-1/4"	250	0.66	30	CGC-125-A1
	1-1/2"	250	0.81	30	CGC-150-A1
	2"	250	1.06	20	CGC-200-A1
	2-1/2"	150	1.28	10	CGC-250-A1
	3"	125	2.07	10	CGC-300-A1
	4"	100	3.30	4	CGC-400-A1
	5"	75	3.97	2	CGC-500-A1
	6"	75	6.24	2	CGC-600-A1
	8"	50	11.02	2	CGC-800-A1
	10"	50	19.40	1	CGC-1000-A



PART C DUCTILE IRON

Vacuum Rating : FULL
Gasket Material : NBR
Gasket Temp. : -40C to +100C(-40F to +212F)
Casting Temp. : -29C to +260C(-20F to +500F)

Size	Max Operating PSI (70F)	Weight (lbs)	Std Pack Qty	Part #
1/2"	250	0.30	100	CGC-050-DP
3/4"	250	0.60	50	CGC-075-DP
1"	250	0.97	60	CGC-100-DP
1-1/4"	250	1.10	40	CGC-125-DP
1-1/2"	250	1.33	30	CGC-150-DP
2"	250	2.00	20	CGC-200-DP
3"	100	3.90	8	CGC-300-DP
4"	100	5.86	6	CGC-400-DP

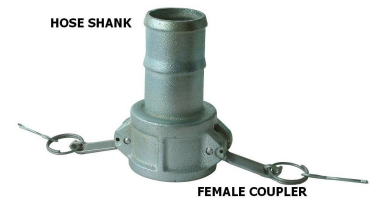

Air and General Purpose Hose

Water Suction and Discharge Hose

Petroleum, Steam and Chemical Hose

Rubber Material Handling Hose

Plastic Material Handling Hose

Food Hose

Ducting

Auto Truck and Marine Hose

Fire Hose

Welding and Other Hose

Cam and Groove

Nipples and Shank Fittings

Clamps

High Pressure Fittings

Mine Fittings

Air Fittings

Valves

Sandblast

Fire Fittings

Pipe Fittings

Sheet Rubber

Index and Technical Information

Air and General Purpose Hose

Water Suction and Discharge Hose

Petroleum, Steam and Chemical Hose

Rubber Material Handling Hose

Plastic Material Handling Hose

Food Hose

Ducting

Auto Truck and Marine Hose

Fire Hose

Welding and Other Hose

Cam and Groove

Nipples, Menders and Shank Fittings

Clamps

High Pressure Fittings

Mine Fittings

Air Fittings

Valves

Sandblast

Fire Fittings

Pipe Fittings

Sheet Rubber

Index and Technical Information

PART C STAINLESS 316

Vacuum Rating : FULL
Gasket Material : NBR
Gasket Temp. : -40C to +100C(-40F to +212F)
Casting Temp. : -101C to +260C(-150F to +500F)

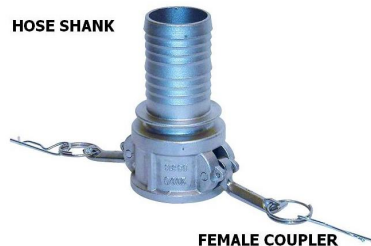

HOSE SHANK

FEMALE COUPLER

Size	Max Operating PSI (70F)	Weight (lbs)	Std Pack Qty	Part #
1/2"	250	0.31	100	CGC-050-SS1
3/4"	250	0.53	50	CGC-075-SS1
1"	250	0.88	50	CGC-100-SS1
1-1/4"	250	1.54	30	CGC-125-SS1
1-1/2"	250	1.63	30	CGC-150-SS1
2"	250	2.83	20	CGC-200-SS1
2-1/2"	200	3.30	10	CGC-250-SS1
3"	200	4.41	10	CGC-300-SS1
4"	100	5.43	4	CGC-400-SS1
5"	75	9.36	2	CGC-500-SS1
6"	75	14.32	2	CGC-600-SS1
8"	50	26.43	1	CGC-800-SS1

PART C BRASS

Vacuum Rating : FULL
Gasket Material : NBR
Gasket Temp. : -40C to +100C(-40F to +212F)
Casting Temp. : -101C to +232C(-150F to +450F)

Size	Max Operating PSI (70F)	Weight (lbs)	Std Pack Qty	Part #
1/2"	250	0.32	100	CGC-050-B1
3/4"	250	0.59	50	CGC-075-B1
1"	250	1.01	60	CGC-100-B1
1-1/4"	250	1.35	40	CGC-125-B1
1-1/2"	250	1.44	30	CGC-150-B1
2"	250	2.12	20	CGC-200-B1
2-1/2"	150	2.78	12	CGC-250-B1
3"	125	4.20	8	CGC-300-B1
4"	100	6.23	6	CGC-400-B1
5"	75	9.82	2	CGC-500-B1
6"	75	15.67	2	CGC-600-B1



HOSE SHANK

FEMALE COUPLER

PART C ALUMINUM WITH STAINLESS HANDLES

Vacuum Rating : FULL
Gasket Material : NBR
Gasket Temp. : -40C to +100C(-40F to +212F)
Casting Temp. : -101C to +121C(-150F to +250F)

Size	Max Operating PSI (70F)	Weight (lbs)	Std Pack Qty	Part #
1/2"	250	0.00	100	CGC-050-A1S
3/4"	250	0.25	50	CGC-075-A1S
1"	250	0.44	50	CGC-100-A1S
1-1/4"	250	0.78	30	CGC-125-A1S
1-1/2"	250	0.82	30	CGC-150-A1S
2"	250	1.06	20	CGC-200-A1S
2-1/2"	150	1.28	10	CGC-250-A1S
3"	125	2.07	10	CGC-300-A1S
4"	100	3.30	4	CGC-400-A1S
5"	75	3.96	2	CGC-500-A1S
6"	75	6.23	2	CGC-600-A1S

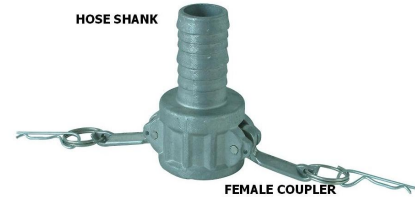

Air and General Purpose Hose

Water Suction and Discharge Hose

Petroleum, Steam and Chemical Hose

Rubber Material Handling Hose

Plastic Material Handling Hose

Food Hose

Ducting

Auto Truck and Marine Hose

Fire Hose

Welding and Other Hose

Cam and Groove

Nipples Menders and Shank Fittings

Clamps

High Pressure Fittings

Mine Fittings

Air Fittings

Valves

Sandblast

Fire Fittings

Pipe Fittings

Sheet Rubber

Index and Technical Information

PART C POLY

Vacuum Rating : FULL
Gasket Material : EPDM
Gasket Temp. : -51C to +100C(-60F to +212F)
Casting Temp. : -26C to +66C(-15F to +150F)

	Size	Max Operating PSI (70F)	Weight (lbs)	Std Pack Qty	Part #
	1/2"	125	0.07	100	CGC-050-PP
	3/4"	125	0.16	50	CGC-075-PP
	1"	125	0.31	50	CGC-100-PP
	1-1/4"	125	0.50	30	CGC-125-PP
	1-1/2"	125	0.55	30	CGC-150-PP
	2"	125	0.73	20	CGC-200-PP
	3"	100	1.24	10	CGC-300-PP
	4"	50	2.20	4	CGC-400-PP

Air and General Purpose Hose

Water Suction and Discharge Hose

Petroleum, Steam and Chemical Hose

Rubber Material Handling Hose

Plastic Material Handling Hose

Food Hose

Ducting

Auto Truck and Marine Hose

Fire Hose

Welding and Other Hose

Cam and Groove

Nipples, Menders and Shank Fittings

Clamps

High Pressure Fittings

Mine Fittings

Air Fittings

Valves

Sandblast

Fire Fittings

Pipe Fittings

Sheet Rubber

Index and Technical Information

PART C NYLON GLASS

Vacuum Rating : FULL
Gasket Material : EPDM
Gasket Temp. : -51C to +100C(-60F to +212F)
Casting Temp. : -34C to +121C(-30F to +250F)

	Size	Max Operating PSI (70F)	Weight (lbs)	Std Pack Qty	Part #
 <p>HOSE SHANK</p> <p>FEMALE COUPLER</p>	1/2"	175	0.04	100	CGC-050-NY
	3/4"	175	0.06	50	CGC-075-NY
	1"	175	0.31	50	CGC-100-NY
	1-1/4"	150	0.55	30	CGC-125-NY
	1-1/2"	150	0.60	30	CGC-150-NY
	2"	150	0.70	20	CGC-200-NY
	3"	100	1.20	10	CGC-300-NY
	4"	50	1.70	4	CGC-400-NY

PART C ALUMINUM REDUCER COUPLER SHANK

Vacuum Rating : FULL
Gasket Material : NBR
Gasket Temp. : -40C to +100C(-40F to +212F)
Casting Temp. : -101C to +121C(-150F to +250F)

Description	Max Operating PSI (70F)	Part #
2"PART C X 1-1/2"SHANK ALUM CAMLOCK	250	CGC-2015-A
3"PART C X2" SHANK ALUM CAMLOCK	125	CGC-3020-A
3"PART C X2-1/2" SHANK ALUM CAMLOCK	125	CGC-3025-A
3"PART C X 4" SHANK ALUM CAMLOCK	125	CGC-3040-A
4"PART C X 3" SHANK ALUM CAMLOCK	100	CGC-4030-A

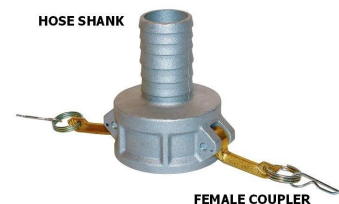

PART C NYLON REDUCER COUPLER SHANK

Vacuum Rating : FULL
Gasket Material : EPDM
Gasket Temp. : -51C to +100C(-60F to +212F)
Casting Temp. : -34C to +121C(-30F to +250F)

	Description	Max Operating PSI (70F)	Part #
 <p>HOSE SHANK</p> <p>FEMALE COUPLER</p>	1-1/2"x1-1/4"NYLON RED.COUPLER/SHANK	175	CGC-1512-NY
	3/4"x1/2" NYLON RED.COUPLER/SHANK	175	CGC-805-NY

PART C POLY REDUCER COUPLER SHANK

Vacuum Rating : FULL
Gasket Material : EPDM
Gasket Temp. : -51C to +100C(-60F to +212F)
Casting Temp. : -26C to +66C(-15F to +150F)

Description	Max Operating PSI (70F)	Part #
1-1/2"x1-1/4"POLY RED.COUPLER/SHANK	125	CGC-1512-PP
3/4"x1/2"POLY RED. COUPLER/SHANK	125	CGC-805-PP



PART C POLY ELBOW 90 DEGREE

Vacuum Rating : FULL
Gasket Material : EPDM
Gasket Temp. : -51C to +100C(-60F to +212F)
Casting Temp. : -26C to +66C(-15F to +150F)

Description	Max Operating PSI (70F)	Part #
1-1/2"PART C 90 DEGREE POLY ELBOW	125	CGC-1590-PP
2"PART C 90 DEGREE POLY ELBOW	125	CGC-2090-PP



PART C ALUMINUM 90 DEGREE

Vacuum Rating : FULL
Gasket Material : NBR
Gasket Temp. : -40C to +100C(-40F to +212F)
Casting Temp. : -101C to +121C(-150F to +250F)

Size	Max Operating PSI (70F)	Weight (lbs)	Std Pack Qty	Part #
1-1/2"	250	1.35	24	CGC-1590-A
2"	250	1.80	24	CGC-2090-A



Air and General Purpose Hose

Water Suction and Discharge Hose

Petroleum, Steam and Chemical Hose

Rubber Material Handling Hose

Plastic Material Handling Hose

Food Hose

Ducting

Auto Truck and Marine Hose

Fire Hose

Welding and Other Hose

Cam and Groove

Nipples, Menders and Shank Fittings

Clamps

High Pressure Fittings

Mine Fittings

Air Fittings

Valves

Sandblast

Fire Fittings

Pipe Fittings

Sheet Rubber

Index and Technical Information

Air and General Purpose Hose

Water Suction and Discharge Hose

Petroleum, Steam and Chemical Hose

Rubber Material Handling Hose

Plastic Material Handling Hose

Food Hose

Ducting

Auto Truck and Marine Hose

Fire Hose

Welding and Other Hose

Cam and Groove

Nipples, Menders and Shank Fittings

Clamps

High Pressure Fittings

Mine Fittings

Air Fittings

Valves

Sandblast

Fire Fittings

Pipe Fittings

Sheet Rubber

Index and Technical Information

PART C SHANK ALUMINUM VAP REC CAM W PROBE

Vacuum Rating : FULL
Gasket Material : NBR
Gasket Temp. : -40C to +100C(-40F to +212F)
Casting Temp. : -101C to +121C(-150F to +250F)

FEMALE COUPLER WITH PROBE

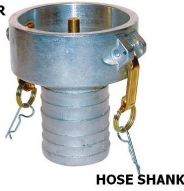

HOSE SHANK

Size	Max Operating PSI (70F)	Weight (lbs)	Std Pack Qty	Part #
4"	100	3.03	4	CGCP-4030-A
3"	125	2.60	4	CGCP-300-A

PART C ALUMINUM QUICKKLOK

Vacuum Rating : FULL
Gasket Material : NBR
Gasket Temp. : -40C to +100C(-40F to +212F)
Casting Temp. : -101C to +121C(-150F to +250F)

Size	Max Operating PSI (70F)	Weight (lbs)	Std Pack Qty	Part #
1-1/2"	250	1.25	30	CGCHK-150-A1
2"	250	1.50	20	CGCHK-200-A1
2-1/2"	150	1.72	10	CGCHK-250-A1
3"	125	2.73	10	CGCHK-300-A1
4"	100	3.96	4	CGCHK-400-A1

HOSE SHANK



FEMALE COUPLER

PART C STAINLESS 316 QUICKKLOK

Vacuum Rating : FULL
Gasket Material : NBR
Gasket Temp. : -40C to +100C(-40F to +212F)
Casting Temp. : -101C to +260C(-150F to +500F)

HOSE SHANK



FEMALE COUPLER

Size	Max Operating PSI (70F)	Weight (lbs)	Std Pack Qty	Part #
1"	250	0.85	40	CGCK-100-SS
1-1/2"	250	2.25	20	CGCK-150-SS
2"	250	3.08	15	CGCK-200-SS
2-1/2"	200	3.59	12	CGCK-250-SS
3"	200	5.56	8	CGCK-300-SS
4"	100	6.69	6	CGCK-400-SS

PART C BRASS QUICKLOK

Vacuum Rating : FULL
Gasket Material : NBR
Gasket Temp. : -40C to +100C(-40F to +212F)
Casting Temp. : -101C to +232C(-150F to +450F)

Size	Max Operating PSI (70F)	Weight (lbs)	Std Pack Qty	Part #
1-1/2"	250	1.88	30	CGCHK-150-B1
2"	250	2.56	20	CGCHK-200-B1
2-1/2"	150	2.79	10	CGCHK-250-B1
3"	125	4.86	10	CGCHK-300-B1
4"	100	6.89	4	CGCHK-400-B1

HOSE SHANK



FEMALE COUPLER

- Air and General Purpose Hose
- Water Suction and Discharge Hose
- Petroleum, Steam and Chemical Hose
- Rubber Material Handling Hose
- Plastic Material Handling Hose
- Food Hose
- Ducting
- Auto Truck and Marine Hose
- Fire Hose
- Welding and Other Hose
- Cam and Groove
- Nipples, Menders and Shank Fittings
- Clamps
- High Pressure Fittings
- Mine Fittings
- Air Fittings
- Valves
- Sandblast
- Fire Fittings
- Pipe Fittings
- Sheet Rubber
- Index and Technical Information

CAM AND GROOVE COUPLINGS FOR LAYFLAT HOSE



Application : For use with thin wall hose such as rubber or pvc layflat. The shank gaskets provide a superior seal eliminating the need for sealants.

Gasket Material : NBR

Gasket Temp. : -40C to +100C(-40F to +212F)

Casting Temp. : -101C to +121C(-150F to +250F)

Description	Weight (lbs)	Std Pack Qty	Part #
1-1/2" PART C ALUM LAYFLAT STYLE	0.81	30	CGCLF-150-A1
2" PART C ALUM LAYFLAT STYLE	1.06	20	CGCLF-200-A1
3" PART C ALUM LAYFLAT STYLE	2.07	10	CGCLF-300-A1
4" PART C ALUM LAYFLAT STYLE	3.30	4	CGCLF-400-A1
1-1/2" PART E ALUM LAYFLAT STYLE	0.49	50	CGELF-150-A1
2" PART E ALUM LAYFLAT STYLE	0.71	25	CGELF-200-A1
3" PART E ALUM LAYFLAT STYLE	1.47	12	CGELF-300-A1
4" PART E ALUM LAYFLAT STYLE	2.48	6	CGELF-400-A1

- Air and General Purpose Hose
- Water Suction and Discharge Hose
- Petroleum, Steam and Chemical Hose
- Rubber Material Handling Hose
- Plastic Material Handling Hose
- Food Hose
- Ducting
- Auto Truck and Marine Hose
- Fire Hose
- Welding and Other Hose
- Cam and Groove
- Nipples Menders and Shank Fittings
- Clamps
- High Pressure Fittings
- Mine Fittings
- Air Fittings
- Valves
- Sandblast
- Fire Fittings
- Pipe Fittings
- Sheet Rubber
- Index and Technical Information

Safety Information : Working Temperature ratings are based on new cam and groove couplings at ambient temperatures. Used or worn couplings or extreme temperature conditions will result in reduced operating pressures. Not for use with compressed gases.

PART D ALUMINUM

Vacuum Rating : FULL
Gasket Material : NBR
Gasket Temp. : -40C to +100C(-40F to +212F)
Casting Temp. : -101C to +121C(-150F to +250F)

	Size	Max Operating PSI (70F)	Weight (lbs)	Std Pack Qty	Part #
	1/2"	250	0.13	100	CGD-050-A1
	3/4"	250	0.25	50	CGD-075-A1
	1"	250	0.39	50	CGD-100-A1
	1-1/4"	250	0.66	40	CGD-125-A1
	1-1/2"	250	0.79	30	CGD-150-A1
	2"	250	0.97	25	CGD-200-A1
	2-1/2"	150	1.20	18	CGD-250-A1
	3"	125	1.89	12	CGD-300-A1
	4"	100	2.71	8	CGD-400-A1
	5"	75	3.31	2	CGD-500-A1
	6"	75	4.63	2	CGD-600-A1
	8"	50	8.82	3	CGD-800-A1
	10"	50	14.00	1	CGD-1000-A

FEMALE NPT



FEMALE COUPLER

PART D DUCTILE IRON

Vacuum Rating : FULL
Gasket Material : NBR
Gasket Temp. : -40C to +100C(-40F to +212F)
Casting Temp. : -29C to +260C(-20F to +500F)

Size	Max Operating PSI (70F)	Weight (lbs)	Std Pack Qty	Part #
1/2"	250	0.30	100	CGD-050-DP
3/4"	250	0.52	50	CGD-075-DP
1"	250	0.94	60	CGD-100-DP
1-1/4"	250	1.32	40	CGD-125-DP
1-1/2"	250	1.32	40	CGD-150-DP
2"	250	1.60	24	CGD-200-DP
3"	100	3.67	12	CGD-300-DP
4"	100	5.20	10	CGD-400-DP
6"	75	9.25	4	CGD-600-DP

FEMALE NPT



FEMALE COUPLER

Air and General Purpose Hose

Water Suction and Discharge Hose

Petroleum, Steam and Chemical Hose

Rubber Material Handling Hose

Plastic Material Handling Hose

Food Hose

Ducting

Auto Truck and Marine Hose

Fire Hose

Welding and Other Hose

Cam and Groove

Nipples, Menders and Shank Fittings

Clamps

High Pressure Fittings

Mine Fittings

Air Fittings

Valves

Sandblast

Fire Fittings

Pipe Fittings

Sheet Rubber

Index and Technical Information

PART D STAINLESS 316

Vacuum Rating : FULL
Gasket Material : NBR
Gasket Temp. : -40C to +100C(-40F to +212F)
Casting Temp. : -101C to +260C(-150F to +500F)

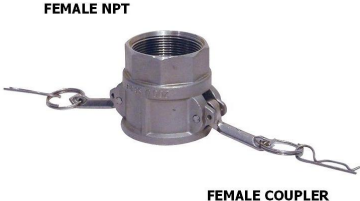
	Size	Max Operating PSI (70F)	Weight (lbs)	Std Pack Qty	Part #
	1/2"	250	0.31	100	CGD-050-SS1
	3/4"	250	0.53	50	CGD-075-SS1
	1"	250	0.81	50	CGD-100-SS1
	1-1/4"	250	1.38	40	CGD-125-SS1
	1-1/2"	250	1.54	30	CGD-150-SS1
	2"	250	1.88	25	CGD-200-SS1
	2-1/2"	200	2.39	18	CGD-250-SS1
	3"	200	3.39	12	CGD-300-SS1
	4"	100	5.12	8	CGD-400-SS1
	5"	75	8.26	2	CGD-500-SS1
	6"	75	13.20	2	CGD-600-SS1
	8"	50	24.00	2	CGD-800-SS1

PART D BRASS

Vacuum Rating : FULL
Gasket Material : NBR
Gasket Temp. : -40C to +100C(-40F to +212F)
Casting Temp. : -101C to +232C(-150F to +450F)

	Size	Max Operating PSI (70F)	Weight (lbs)	Std Pack Qty	Part #
High Pressure Fittings	1/2"	250	0.32	100	CGD-050-B1
	3/4"	250	0.54	50	CGD-075-B1
Mine Fittings	1"	250	0.97	60	CGD-100-B1
Air Fittings	1-1/4"	250	1.18	40	CGD-125-B1
	1-1/2"	250	1.33	40	CGD-150-B1
Valves	2"	250	1.63	24	CGD-200-B1
	2-1/2"	150	2.58	24	CGD-250-B1
Fire Fittings	3"	125	3.90	12	CGD-300-B1
	4"	100	5.40	10	CGD-400-B1
Pipe Fittings	5"	75	9.08	4	CGD-500-B1
	6"	75	13.22	3	CGD-600-B1

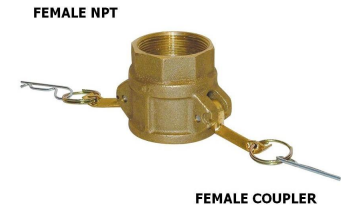

PART D ALUMINUM WITH STAINLESS HANDLES

Vacuum Rating : FULL
Gasket Material : NBR
Gasket Temp. : -40C to +100C(-40F to +212F)
Casting Temp. : -101C to +121C(-150F to +250F)

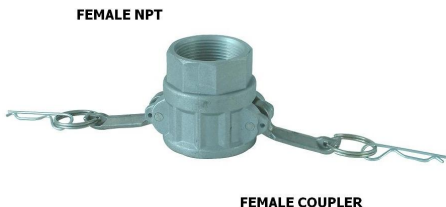
	Size	Max Operating PSI (70F)	Weight (lbs)	Std Pack Qty	Part #
 <p>FEMALE NPT</p> <p>FEMALE COUPLER</p>	1/2"	250	0.13	100	CGD-050-A1S
	3/4"	250	0.25	50	CGD-075-A1S
	1"	250	0.40	50	CGD-100-A1S
	1-1/4"	250	0.66	40	CGD-125-A1S
	1-1/2"	250	0.80	30	CGD-150-A1S
	2"	250	0.98	25	CGD-200-A1S
	2-1/2"	150	1.21	18	CGD-250-A1S
	3"	125	1.90	12	CGD-300-A1S
	4"	100	2.71	8	CGD-400-A1S
	5"	75	3.30	2	CGD-500-A1S
	6"	75	4.62	2	CGD-600-A1S

PART D POLY

Vacuum Rating : FULL
Gasket Material : EPDM
Gasket Temp. : -51C to +100C(-60F to +212F)
Casting Temp. : -26C to +66C(-15F to +150F)

Size	Max Operating PSI (70F)	Weight (lbs)	Std Pack Qty	Part #
1/2"	125	0.09	100	CGD-050-PP
3/4"	125	0.20	50	CGD-075-PP
1"	125	0.28	50	CGD-100-PP
1-1/4"	125	0.47	40	CGD-125-PP
1-1/2"	125	0.50	30	CGD-150-PP
2"	125	0.62	25	CGD-200-PP
3"	100	1.22	12	CGD-300-PP
4"	50	1.60	8	CGD-400-PP

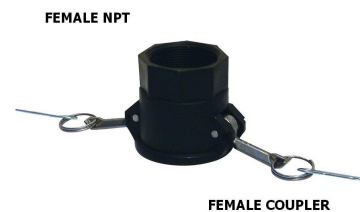

- Air and General Purpose Hose
- Water Suction and Discharge Hose
- Petroleum, Steam and Chemical Hose
- Rubber Material Handling Hose
- Plastic Material Handling Hose
- Food Hose
- Ducting
- Auto Truck and Marine Hose
- Fire Hose
- Welding and Other Hose
- Cam and Groove
- Nipples Menders and Shank Fittings
- Clamps
- High Pressure Fittings
- Mine Fittings
- Air Fittings
- Valves
- Sandblast
- Fire Fittings
- Pipe Fittings
- Sheet Rubber
- Index and Technical Information

Air and General Purpose Hose

Water Suction and Discharge Hose

Petroleum, Steam and Chemical Hose

Rubber Material Handling Hose

Plastic Material Handling Hose

Food Hose

Ducting

Auto Truck and Marine Hose

Fire Hose

Welding and Other Hose

Cam and Groove

Nipples, Menders and Shank Fittings

Clamps

High Pressure Fittings

Mine Fittings

Air Fittings

Valves

Sandblast

Fire Fittings

Pipe Fittings

Sheet Rubber

Index and Technical Information

PART D NYLON GLASS

Vacuum Rating : FULL
Gasket Material : EPDM
Gasket Temp. : -51C to +100C(-60F to +212F)
Casting Temp. : -34C to +121C(-30F to +250F)

	Size	Max Operating PSI (70F)	Weight (lbs)	Std Pack Qty	Part #
	1/2"	175	0.09	100	CGD-050-NY
	3/4"	175	0.20	50	CGD-075-NY
	1"	175	0.28	50	CGD-100-NY
	1-1/4"	150	0.47	40	CGD-125-NY
	1-1/2"	150	0.53	30	CGD-150-NY
	2"	150	1.50	25	CGD-200-NY
	3"	100	1.00	12	CGD-300-NY
	4"	50	1.50	8	CGD-400-NY

PART D ALUMINUM BSP THREAD

Vacuum Rating : FULL
Gasket Material : NBR
Gasket Temp. : -40C to +100C(-40F to +212F)
Casting Temp. : -101C to +121C(-150F to +250F)

Size	Max Operating PSI (70F)	Weight (lbs)	Std Pack Qty	Part #
1-1/2"	250	0.79	30	CGDBSP-150-A1
2"	250	0.97	25	CGDBSP-200-A1
3"	125	1.89	12	CGDBSP-300-A1
4"	100	2.71	8	CGDBSP-400-A1
5"	75	3.30	2	CGDBSP-500-A1
6"	75	4.63	2	CGDBSP-600-A1



PART D STAINLESS 316 BSP THREAD

Vacuum Rating : FULL
Gasket Material : NBR
Gasket Temp. : -40C to +100C(-40F to +212F)
Casting Temp. : -101C to +260C(-150F to +500F)

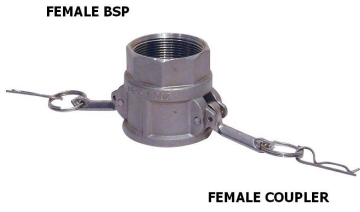
	Size	Max Operating PSI (70F)	Weight (lbs)	Std Pack Qty	Part #
	1"	250	0.81	50	CGDBSP-100-SS1
	1-1/2"	250	1.39	30	CGDBSP-150-SS1
	2"	250	1.88	25	CGDBSP-200-SS1
	2-1/2"	200	2.39	18	CGDBSP-250-SS1
	3"	200	3.39	12	CGDBSP-300-SS1
	4"	100	5.12	8	CGDBSP-400-SS1

PART D REDUCER COUPLER ADAPTER ALUMINUM

Vacuum Rating : FULL
Gasket Material : NBR
Gasket Temp. : -40C to +100C(-40F to +212F)
Casting Temp. : -101C to +121C(-150F to +250F)

Description	Max Operating PSI (70F)	Part #
1-1/2"X1"REDUCER COUPLER/ADAPTER ALUM	250	DA-1510-A
1-1/2"X2"REDUCER COUPLER/ADAPTER ALUM	250	DA-1520-A
2"X1-1/2"REDUCER COUPLER/ADAPTER ALUM	250	DA-2015-A
2"X3"REDUCER COUPLER/ADAPTER ALUM	250	DA-2030-A
2"X4"REDUCER COUPLER/ADAPTER ALUM	250	DA-2040-A
3"X1-1/2"REDUCER COUPLER/ADAPTER ALUM	125	DA-3015-A
3"X2"REDUCER COUPLER/ADAPTER ALUM	125	DA-3020-A
3"X4"REDUCER COUPLER/ADAPTER ALUM	125	DA-3040-A
4"X2"REDUCER COUPLER/ADAPTER ALUM	100	DA-4020-A
4"X3"REDUCER COUPLER/ADAPTER ALUM	100	DA-4030-A
4"X6"REDUCER COUPLER/ADAPTER ALUM	100	DA-4060-A
6"X4"REDUCER COUPLER/ADAPTER ALUM	75	DA-6040-A
6"X5"REDUCER COUPLER/ADAPTER ALUM	75	DA-6050-A

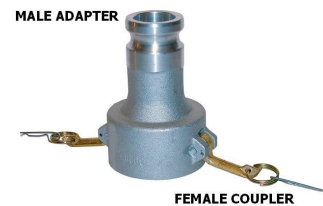

Air and General Purpose Hose
 Water Suction and Discharge Hose
 Petroleum, Steam and Chemical Hose
 Rubber Material Handling Hose
 Plastic Material Handling Hose
 Food Hose
 Ducting
 Auto Truck and Marine Hose
 Fire Hose
 Welding and Other Hose
 Cam and Groove
 Nipples Menders and Shank Fittings
 Clamps
 High Pressure Fittings
 Mine Fittings
 Air Fittings
 Valves
 Sandblast
 Fire Fittings
 Pipe Fittings
 Sheet Rubber
 Index and Technical Information

Air and General Purpose Hose

Water Suction and Discharge Hose

Petroleum, Steam and Chemical Hose

Rubber Material Handling Hose

Plastic Material Handling Hose

Food Hose

Ducting

Auto Truck and Marine Hose

Fire Hose

Welding and Other Hose

Cam and Groove

Nipples, Menders and Shank Fittings

Clamps

High Pressure Fittings

Mine Fittings

Air Fittings

Valves

Sandblast

Fire Fittings

Pipe Fittings

Sheet Rubber

Index and Technical Information

PART D REDUCER COUPLER ADAPTER STAINLESS 316

Vacuum Rating : FULL
Gasket Material : NBR
Gasket Temp. : -40C to +100C(-40F to +212F)
Casting Temp. : -101C to +260C(-150F to +500F)

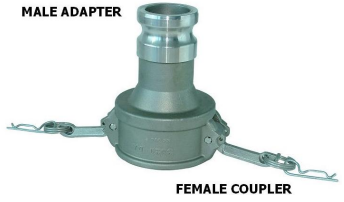

Description	Max Operating PSI (70F)	Part #
2"X3"REDUCER COUPLER/ADAPTER STAIN.	250	DA-2030-SS
2-1/2"X2"REDUCER COUPLER/ADAPTER STAIN.	200	DA-2520-SS
3"X2"REDUCER COUPLER/ADAPTER STAIN.	200	DA-3020-SS
4"X3"REDUCER COUPLER/ADAPTER STAIN.	100	DA-4030-SS
6"X4"REDUCER COUPLER/ADAPTER STAIN.	75	DA-6040-SS

PART D REDUCER COUPLER ADAPTER BRASS

Vacuum Rating : FULL
Gasket Material : NBR
Gasket Temp. : -40C to +100C(-40F to +212F)
Casting Temp. : -101C to +232C(-150F to +450F)

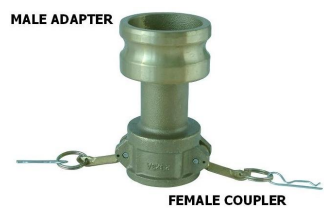

Description	Max Operating PSI (70F)	Part #
2"X3"BRASS COUPLER/ADAPT.REDUCER	125	DA-2030-B
3"X2"BRASS COUPLER/ADAPT.REDUCER	125	DA-3020-B
4"X2"BRASS COUPLER/ADAPT.REDUCER	100	DA-4020-B
4"X3"BRASS COUPLER/ADAPT.REDUCER	100	DA-4030-B
6"X4"BRASS COUPLER/ADAPT.REDUCER	75	DA-6040-B

PART D REDUCER COUPLER FEMALE NPT ALUMINUM

Vacuum Rating : FULL
Gasket Material : NBR
Gasket Temp. : -40C to +100C(-40F to +212F)
Casting Temp. : -101C to +121C(-150F to +250F)

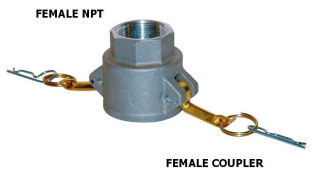

Description	Max Operating PSI (70F)	Part #
1-1/2"x1"REDUCER COUPLER/FEM NPT ALUM	250	CGD-1510-A
2"x1-1/2"REDUCER COUPLER/FEM NPT ALUM	250	CGD-2015-A
3"x2"REDUCER COUPLER/FEM NPT ALUM	125	CGD-3020-A
4"x3"REDUCER COUPLER/FEM NPT ALUM	100	CGD-4030-A

PART D SPOOL COUPLER ALUMINUM

Vacuum Rating : FULL
Gasket Temp. : -40C to +100C(-40F to +212F)
Casting Temp. : -101C to +121C(-150F to +250F)

Description	Max Operating PSI (70F)	Part #
1-1/2"x1-1/2"SPOOL COUPLER ALUM.	250	DD-1515-A
2"x2" SPOOL COUPLER ALUMINUM	250	DD-2020-A
2"x3" SPOOL COUPLER ALUMINUM	250	DD-2030-A
3"x3" SPOOL COUPLER ALUMINUM	125	DD-3030-A
3"x4" SPOOL COUPLER ALUMINUM	125	DD-3040-A
4"x4" SPOOL COUPLER ALUMINUM	100	DD-4040-A



Air and General Purpose Hose
 Water Suction and Discharge Hose
 Petroleum, Steam and Chemical Hose
 Rubber Material Handling Hose
 Plastic Material Handling Hose

PART D SPOOL COUPLER STAINLESS 316

Vacuum Rating : FULL
Gasket Temp. : -40C to +100C(-40F to +212F)
Casting Temp. : -101C to +260C(-150F to +500F)

Description	Max Operating PSI (70F)	Part #
1-1/2"x1-1/2"SPOOL COUPLER STAIN.	250	DD-1515-SS
2"x2" SPOOL COUPLER STAINLESS	250	DD-2020-SS
3"x3" SPOOL COUPLER STAINLESS	200	DD-3030-SS
4"x4" SPOOL COUPLER STAINLESS	100	DD-4040-SS
5" COUPLER X 4" COUPLER STAINLESS	75	DD-5040-SS

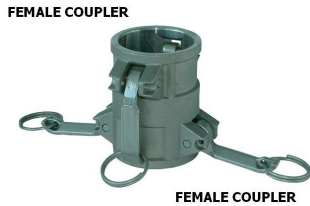

Food Hose
 Ducting
 Auto Truck and Marine Hose
 Fire Hose
 Welding and Other Hose
 Cam and Groove
 Nipples Menders and Shank Fittings

PART D POLY REDUCER COUPLER FEMALE NPT

Vacuum Rating : FULL
Gasket Material : EPDM
Gasket Temp. : -51C to +100C(-60F to +212F)
Casting Temp. : -26C to +66C(-15F to +150F)

Description	Max Operating PSI (70F)	Part #
1-1/2"x1-1/4"POLY RED.COUP./FEM.NPT	125	CGD-1512-PP
3/4"x1/2"POLY RED. COUPLER/FEM.NPT	125	CGD-805-PP

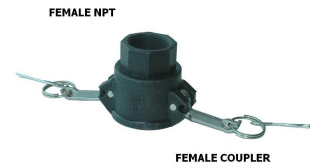

Clamps
 High Pressure Fittings
 Mine Fittings
 Air Fittings
 Valves
 Sandblast
 Fire Fittings
 Pipe Fittings
 Sheet Rubber
 Index and Technical Information

Air and General Purpose Hose

Water Suction and Discharge Hose

Petroleum, Steam and Chemical Hose

Rubber Material Handling Hose

Plastic Material Handling Hose

Food Hose

Ducting

Auto Truck and Marine Hose

Fire Hose

Welding and Other Hose

Cam and Groove

Nipples, Menders and Shank Fittings

Clamps

High Pressure Fittings

Mine Fittings

Air Fittings

Valves

Sandblast

Fire Fittings

Pipe Fittings

Sheet Rubber

Index and Technical Information

PART D NYLON REDUCER COUPLER FEMALE NPT

Vacuum Rating : FULL
Gasket Material : EPDM
Gasket Temp. : -51C to +100C(-60F to +212F)
Casting Temp. : -34C to +121C(-30F to +250F)

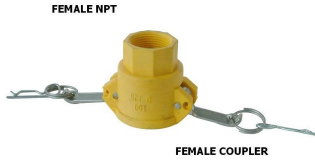

Description	Max Operating PSI (70F)	Part #
1-1/2"x1-1/4"NYLON RED.COUP./FEM.NPT	175	CGD-1512-NY
3/4"x1/2"NYLON RED.COUP./FEM.NPT	175	CGD-805-NY

PART D 90 DEG STAINLESS ELBOW

Vacuum Rating : FULL
Gasket Material : NBR
Gasket Temp. : -40C to +100C(-40F to +212F)
Casting Temp. : -101C to +260C(-150F to +500F)

Size	Max Operating PSI (70F)	Weight (lbs)	Std Pack Qty	Part #
2"	250	3.50	10	CGD-2090-SS



PART D POLY ELBOW 90 DEGREE

Vacuum Rating : FULL
Gasket Material : EPDM
Gasket Temp. : -51C to +100C(-60F to +212F)
Casting Temp. : -26C to +66C(-15F to +150F)



Description	Max Operating PSI (70F)	Part #
1-1/2"PART D 90 DEGREE POLY ELBOW	125	CGD-1590-PP
2"PART D 90 DEGREE POLY ELBOW	125	CGD-2090-PP

PART D ALUMINUM QUICKKLOK

Vacuum Rating : FULL
Gasket Material : NBR
Gasket Temp. : -40C to +100C(-40F to +212F)
Casting Temp. : -101C to +121C(-150F to +250F)

Size	Max Operating PSI (70F)	Weight (lbs)	Std Pack Qty	Part #
1-1/2"	250	1.23	30	CGDHK-150-A1
2"	250	1.41	25	CGDHK-200-A1
2-1/2"	150	1.20	18	CGDHK-250-A1
3"	125	2.55	12	CGDHK-300-A1
4"	100	3.37	8	CGDHK-400-A1

FEMALE NPT



FEMALE COUPLER

PART D STAINLESS 316 QUICKKLOK

Vacuum Rating : FULL
Gasket Material : NBR
Gasket Temp. : -40C to +100C(-40F to +212F)
Casting Temp. : -101C to +260C(-150F to +500F)

Size	Max Operating PSI (70F)	Weight (lbs)	Std Pack Qty	Part #
1"	250	0.85	40	CGDK-100-SS
1-1/2"	250	1.98	24	CGDK-150-SS
2"	250	2.53	24	CGDK-200-SS
2-1/2"	200	2.57	20	CGDK-250-SS
3"	200	4.42	12	CGDK-300-SS
4"	100	6.35	10	CGDK-400-SS

FEMALE NPT



FEMALE COUPLER

PART D BRASS QUICKKLOK

Vacuum Rating : FULL
Gasket Material : NBR
Gasket Temp. : -40C to +100C(-40F to +212F)
Casting Temp. : -101C to +232C(-150F to +450F)

Size	Max Operating PSI (70F)	Weight (lbs)	Std Pack Qty	Part #
1-1/2"	250	1.77	30	CGDHK-150-B1
2"	250	2.07	25	CGDHK-200-B1
2-1/2"	150	2.58	18	CGDHK-250-B1
3"	125	4.23	12	CGDHK-300-B1
4"	100	6.06	8	CGDHK-400-B1

FEMALE NPT



FEMALE COUPLER

Air and General Purpose Hose

Water Suction and Discharge Hose

Petroleum, Steam and Chemical Hose

Rubber Material Handling Hose

Plastic Material Handling Hose

Food Hose

Ducting

Auto Truck and Marine Hose

Fire Hose

Welding and Other Hose

Cam and Groove

Nipples, Menders and Shank Fittings

Clamps

High Pressure Fittings

Mine Fittings

Air Fittings

Valves

Sandblast

Fire Fittings

Pipe Fittings

Sheet Rubber

Index and Technical Information

Safety Information : NOT FOR USE WITH COMPRESSED GASES

PART E ALUMINUM

Casting Temp. : -101C to +121C(-150F to +250F)

Size	Weight (lbs)	Std Pack Qty	Part #
1/2"	0.10	100	CGE-050-A1
3/4"	0.12	50	CGE-075-A1
1"	0.20	50	CGE-100-A1
1-1/4"	0.35	50	CGE-125-A1
1-1/2"	0.49	50	CGE-150-A1
2"	0.71	25	CGE-200-A1
2-1/2"	1.01	12	CGE-250-A1
3"	1.47	12	CGE-300-A1
4"	2.48	6	CGE-400-A1
5"	3.31	2	CGE-500-A1
6"	4.41	2	CGE-600-A1
8"	5.14	4	CGE-800-A1
10"	14.20	1	CGE-1000-A



PART E STAINLESS 316

Casting Temp. : -101C to +260C(-150F to +500F)

Size	Weight (lbs)	Std Pack Qty	Part #
1/2"	0.18	100	CGE-050-SS1
3/4"	0.35	50	CGE-075-SS1
1"	0.81	50	CGE-100-SS1
1-1/4"	0.92	50	CGE-125-SS1
1-1/2"	1.29	50	CGE-150-SS1
2"	2.08	25	CGE-200-SS1
2-1/2"	2.86	12	CGE-250-SS1
3"	4.04	12	CGE-300-SS1
4"	6.59	6	CGE-400-SS1
5"	8.81	2	CGE-500-SS1
6"	12.11	2	CGE-600-SS1
8"	16.25	2	CGE-800-SS1



- Air and General Purpose Hose
- Water Suction and Discharge Hose
- Petroleum, Steam and Chemical Hose
- Rubber Material Handling Hose
- Plastic Material Handling Hose
- Food Hose
- Ducting
- Auto Truck and Marine Hose
- Fire Hose
- Welding and Other Hose
- Cam and Groove
- Nipples Menders and Shank Fittings
- Clamps
- High Pressure Fittings
- Mine Fittings
- Air Fittings
- Valves
- Sandblast
- Fire Fittings
- Pipe Fittings
- Sheet Rubber
- Index and Technical Information

Air and General Purpose Hose

PART E BRASS

Casting Temp. : -101C to +232C(-150F to +450F)

Water Suction and Discharge Hose

Petroleum, Steam and Chemical Hose

Rubber Material Handling Hose

Plastic Material Handling Hose

Food Hose

Ducting

Auto Truck and Marine Hose

Fire Hose

Welding and Other Hose

Cam and Groove

Nipples, Menders and Shank Fittings

Clamps

High Pressure Fittings

Mine Fittings

Air Fittings

Valves

Sandblast

Fire Fittings

Pipe Fittings

Sheet Rubber

Index and Technical Information

	Size	Weight (lbs)	Std Pack Qty	Part #
HOSE SHANK 	1/2"	0.25	100	CGE-050-B1
	3/4"	0.35	50	CGE-075-B1
	1"	0.54	60	CGE-100-B1
	1-1/4"	1.00	60	CGE-125-B1
	1-1/2"	1.11	36	CGE-150-B1
	2"	1.72	24	CGE-200-B1
	2-1/2"	2.36	20	CGE-250-B1
	3"	2.81	12	CGE-300-B1
	4"	5.12	6	CGE-400-B1
	5"	9.86	4	CGE-500-B1
	6"	16.79	2	CGE-600-B1

MALE ADAPTER

PART E DUCTILE IRON

Casting Temp. : -29C to +260C(-20F to +500F)

Size	Weight (lbs)	Std Pack Qty	Part #
1/2"	0.22	100	CGE-050-DP
3/4"	0.31	50	CGE-075-DP
1"	0.64	60	CGE-100-DP
1-1/4"	0.88	60	CGE-125-DP
1-1/2"	1.07	36	CGE-150-DP
2"	1.60	24	CGE-200-DP
3"	2.70	12	CGE-300-DP
4"	4.40	6	CGE-400-DP

HOSE SHANK



MALE ADAPTER

PART E POLY

Casting Temp. : -26C to +66C(-15F to +150F)

	Size	Weight (lbs)	Std Pack Qty	Part #
HOSE SHANK 	1/2"	0.03	100	CGE-050-PP
	3/4"	0.04	50	CGE-075-PP
	1"	0.12	50	CGE-100-PP
	1-1/4"	0.15	50	CGE-125-PP
	1-1/2"	0.22	50	CGE-150-PP
	2"	0.31	25	CGE-200-PP
	3"	0.83	12	CGE-300-PP
	4"	1.01	8	CGE-400-PP

MALE ADAPTER

PART E NYLON GLASS

Casting Temp. : -34C to +121C(-30F to +250F)

Size	Weight (lbs)	Std Pack Qty	Part #
1/2"	0.04	100	CGE-050-NY
3/4"	0.07	50	CGE-075-NY
1"	0.12	50	CGE-100-NY
1-1/4"	0.15	50	CGE-125-NY
1-1/2"	0.26	50	CGE-150-NY
2"	0.40	25	CGE-200-NY
3"	1.00	12	CGE-300-NY
4"	1.20	8	CGE-400-NY

HOSE SHANK



MALE ADAPTER

Air and General Purpose Hose

Water Suction and Discharge Hose

Petroleum, Steam and Chemical Hose

Rubber Material Handling Hose

Plastic Material Handling Hose

Food Hose

Ducting

Auto Truck and Marine Hose

Fire Hose

Welding and Other Hose

Cam and Groove

Nipples Menders and Shank Fittings

Clamps

High Pressure Fittings

Mine Fittings

Air Fittings

Valves

Sandblast

Fire Fittings

Pipe Fittings

Sheet Rubber

Index and Technical Information

PART E SHANK ALUMINUM CAMLOCK

Casting Temp. : -101C to +121C(-150F to +250F)

MALE ADAPTER



HOSE SHANK

Description	Weight (lbs)	Part #
2"PART E X 1-1/2"SHANK ALUM CAMLOCK	0.66	CGE-2015-A
2"PART E X 2-1/2"SHANK ALUM CAMLOCK	1.00	CGE-2025-A
2"PART E X 3" SHANK ALUM CAMLOCK	1.15	CGE-2030-A
3"PART E X 2" SHANK ALUM CAMLOCK	1.15	CGE-3020-A
3"PART E X2-1/2" SHANK ALUM CAMLOCK	3.31	CGE-3025-A
3"PART E X 4" SHANK ALUM CAMLOCK	1.96	CGE-3040-A
4"PART E X 2" SHANK ALUM CAMLOCK	2.20	CGE-4020-A
4"PART E X 3" SHANK ALUM CAMLOCK	1.96	CGE-4030-A

PART E NYLON REDUCER ADAPTER SHANK

Casting Temp. : -34C to +121C(-30F to +250F)

Description	Weight (lbs)	Part #
1-1/2"x1-1/4"NYLON RED.ADAPT./SHANK	0.16	CGE-1512-NY
3/4"x1/2"NYLON RED.ADAPT./SHANK	0.08	CGE-805-NY

HOSE SHANK



MALE ADAPTER

PART E POLY REDUCER ADAPTER SHANK

Casting Temp. : -26C to +66C(-15F to +150F)

Description	Weight (lbs)	Part #
1-1/2"x1-1/4"POLY RED.ADAPT./SHANK	0.22	CGE-1512-PP
3/4"x1/2"POLY RED. ADAPTER/SHANK	0.02	CGE-805-PP

HOSE SHANK



MALE ADAPTER

Safety Information : NOT FOR USE WITH COMPRESSED GASES

PART F ALUMINUM

Casting Temp. : -101C to +121C(-150F to +250F)

Size	Weight (lbs)	Std Pack Qty	Part #
1/2"	0.10	100	CGF-050-A1
3/4"	0.16	50	CGF-075-A1
1"	0.20	40	CGF-100-A1
1-1/4"	0.31	50	CGF-125-A1
1-1/2"	0.45	50	CGF-150-A1
2"	0.65	30	CGF-200-A1
2-1/2"	0.92	20	CGF-250-A1
3"	1.28	15	CGF-300-A1
4"	1.47	5	CGF-400-A1
5"	1.84	2	CGF-500-A1
6"	2.33	2	CGF-600-A1
8"	8.82	2	CGF-800-A1
10"	14.20	1	CGF-1000-A

MALE ADAPTER



MALE NPT

PART F STAINLESS 316

Casting Temp. : -101C to +260C(-150F to +500F)

Size	Weight (lbs)	Std Pack Qty	Part #
1/2"	0.26	100	CGF-050-SS1
3/4"	0.48	50	CGF-075-SS1
1"	0.62	40	CGF-100-SS1
1-1/4"	0.95	50	CGF-125-SS1
1-1/2"	1.22	50	CGF-150-SS1
2"	1.72	30	CGF-200-SS1
2-1/2"	2.66	20	CGF-250-SS1
3"	3.08	15	CGF-300-SS1
4"	6.11	5	CGF-400-SS1
5"	8.26	2	CGF-500-SS1
6"	12.67	2	CGF-600-SS1
8"	22.00	2	CGF-800-SS1

MALE ADAPTER



MALE NPT

Air and General Purpose Hose

Water Suction and Discharge Hose

Petroleum, Steam and Chemical Hose

Rubber Material Handling Hose

Plastic Material Handling Hose

Food Hose

Ducting

Auto Truck and Marine Hose

Fire Hose

Welding and Other Hose

Cam and Groove

Nipples, Menders and Shank Fittings

Clamps

High Pressure Fittings

Mine Fittings

Air Fittings

Valves

Sandblast

Fire Fittings

Pipe Fittings

Sheet Rubber

Index and Technical Information

Air and General Purpose Hose

PART F BRASS

Casting Temp. : -101C to +232C(-150F to +450F)

	Size	Weight (lbs)	Std Pack Qty	Part #
MALE ADAPTER	1/2"	0.32	100	CGF-050-B1
	3/4"	0.46	50	CGF-075-B1
	1"	0.64	50	CGF-100-B1
	1-1/4"	1.20	60	CGF-125-B1
	1-1/2"	0.88	60	CGF-150-B1
	2"	1.25	40	CGF-200-B1
	2-1/2"	2.47	20	CGF-250-B1
	3"	2.60	20	CGF-300-B1
	4"	4.24	12	CGF-400-B1
	5"	8.06	4	CGF-500-B1
	6"	9.18	4	CGF-600-B1



MALE NPT

PART F DUCTILE IRON

Casting Temp. : -29C to +260C(-20F to +500F)

	Size	Weight (lbs)	Std Pack Qty	Part #
MALE ADAPTER	1/2"	0.28	100	CGF-050-DP
	3/4"	0.40	50	CGF-075-DP
	1"	0.62	50	CGF-100-DP
	1-1/4"	1.16	60	CGF-125-DP
	1-1/2"	0.80	60	CGF-150-DP
	2"	1.16	40	CGF-200-DP
	3"	2.48	20	CGF-300-DP
	4"	3.66	12	CGF-400-DP

MALE ADAPTER



MALE NPT

PART F POLY

Casting Temp. : -26C to +66C(-15F to +150F)

	Size	Weight (lbs)	Std Pack Qty	Part #
MALE ADAPTER	1/2"	0.10	100	CGF-050-PP
	3/4"	0.07	50	CGF-075-PP
	1"	0.09	50	CGF-100-PP
	1-1/4"	0.20	50	CGF-125-PP
	1-1/2"	0.22	50	CGF-150-PP
	2"	0.31	30	CGF-200-PP
	3"	0.66	15	CGF-300-PP
	4"	1.01	5	CGF-400-PP



MALE NPT

PART F NYLON GLASS

Casting Temp. : -34C to +121C(-30F to +250F)

Size	Weight (lbs)	Std Pack Qty	Part #
1/2"	0.02	100	CGF-050-NY
3/4"	0.07	50	CGF-075-NY
1"	0.09	50	CGF-100-NY
1-1/4"	0.20	50	CGF-125-NY
1-1/2"	0.25	50	CGF-150-NY
2"	0.35	30	CGF-200-NY
3"	0.70	15	CGF-300-NY
4"	1.00	5	CGF-400-NY

MALE ADAPTER



MALE NPT

Air and General Purpose Hose

Water Suction and Discharge Hose

Petroleum, Steam and Chemical Hose

Rubber Material Handling Hose

Plastic Material Handling Hose

Food Hose

Ducting

Auto Truck and Marine Hose

Fire Hose

Welding and Other Hose

Cam and Groove

Nipples, Menders and Shank Fittings

Clamps

High Pressure Fittings

Mine Fittings

Air Fittings

Valves

Sandblast

Fire Fittings

Pipe Fittings

Sheet Rubber

Index and Technical Information

PART F ALUMINUM BSP THREAD

Casting Temp. : -101C to +121C(-150F to +250F)

MALE ADAPTER



MALE BSP

Size	Weight (lbs)	Std Pack Qty	Part #
1-1/2"	0.45	50	CGFBSP-150-A1
2"	0.65	30	CGFBSP-200-A1
3"	1.28	15	CGFBSP-300-A1
4"	1.47	5	CGFBSP-400-A1
6"	2.33	2	CGFBSP-600-A1
8"	8.82	2	CGFBSP-800-A1

PART F STAINLESS 316 BSP THREAD

Casting Temp. : -101C to +260C(-150F to +500F)

Size	Weight (lbs)	Std Pack Qty	Part #
1"	0.62	40	CGFBSP-100-SS1
1-1/2"	1.22	50	CGFBSP-150-SS1
2"	1.72	30	CGFBSP-200-SS1
3"	3.08	15	CGFBSP-300-SS1
4"	6.11	5	CGFBSP-400-SS1
6"	12.67	2	CGFBSP-600-SS1

MALE ADAPTER



MALE BSP

Air and General Purpose Hose

Water Suction and Discharge Hose

Petroleum, Steam and Chemical Hose

Rubber Material Handling Hose

Plastic Material Handling Hose

Food Hose

Ducting

Auto Truck and Marine Hose

Fire Hose

Welding and Other Hose

Cam and Groove

Nipples, Menders and Shank Fittings

Clamps

High Pressure Fittings

Mine Fittings

Air Fittings

Valves

Sandblast

Fire Fittings

Pipe Fittings

Sheet Rubber

Index and Technical Information

PART F REDUCER ADAPTER MALE NPT ALUMINUM

Casting Temp. : -101C to +121C(-150F to +250F)

MALE NPT



MALE ADAPTER

Description	Weight (lbs)	Part #
1-1/2"X2"RED. ADAPTER/MALE NPT ALUM	0.55	CGF-1520-A
2"X1-1/2"RED. ADAPTER/MALE NPT ALUM	0.61	CGF-2015-A
2"X3"REDUCER ADAPTER/MALE NPT ALUM	1.10	CGF-2030-A
3"X2"REDUCER ADAPTER/MALE NPT ALUM	0.92	CGF-3020-A
3"X4"REDUCER ADAPTER/MALE NPT ALUM	1.76	CGF-3040-A
4"X3"REDUCER ADAPTER/MALE NPT ALUM	1.62	CGF-4030-A
4"X6"REDUCER ADAPTER/MALE NPT ALUM	2.64	CGF-4060-A

PART F NYLON REDUCER ADAPTER MALE NPT

Casting Temp. : -34C to +121C(-30F to +250F)

Description	Weight (lbs)	Part #
1-1/2"x1-1/4"NYLON RED.ADAP/MALE NPT	0.21	CGF-1512-NY
3/4"x1/2"NYLON RED.ADAP/MALE NPT	0.08	CGF-805-NY

MALE NPT



MALE ADAPTER

PART F POLY REDUCER ADAPTER MALE NPT

Casting Temp. : -26C to +66C(-15F to +150F)

MALE NPT



MALE ADAPTER

Description	Weight (lbs)	Part #
1-1/2"x1-1/4"POLY RED.ADAP/MALE NPT	0.22	CGF-1512-PP
3/4"x1/2"POLY RED. ADAPT./MALE NPT	0.09	CGF-805-PP

PART F POLY ELBOW 90 DEGREE

Casting Temp. : -26C to +66C(-15F to +150F)

Size	Weight (lbs)	Std Pack Qty	Part #
1-1/2"	0.22	24	CGF-1590-PP
2"	0.44	24	CGF-2090-PP

MALE NPT



MALE ADAPTER

Safety Information : Working Temperature ratings are based on new cam and groove couplings at ambient temperatures. Used or worn couplings or extreme temperature conditions will result in reduced operating pressures. Not for use with compressed gases.

DUST CAP ALUMINUM

Vacuum Rating : FULL
Gasket Material : NBR
Gasket Temp. : -40C to +100C(-40F to +212F)
Casting Temp. : -101C to +121C(-150F to +250F)

Size	Max Operating PSI (70F)	Weight (lbs)	Std Pack Qty	Part #
1/2"	250	0.12	100	CDC-050-A1
3/4"	250	0.23	50	CDC-075-A1
1"	250	0.36	50	CDC-100-A1
1-1/4"	250	0.61	40	CDC-125-A1
1-1/2"	250	0.68	40	CDC-150-A1
2"	250	0.82	30	CDC-200-A1
2-1/2"	150	0.98	20	CDC-250-A1
3"	125	1.47	15	CDC-300-A1
4"	100	2.28	10	CDC-400-A1
5"	75	2.57	2	CDC-500-A1
6"	75	4.22	2	CDC-600-A1
8"	50	6.61	4	CDC-800-A1
10"	50	15.80	2	CDC-1000-A



DUST CAP DUCTILE IRON

Vacuum Rating : FULL
Gasket Material : NBR
Gasket Temp. : -40C to +100C(-40F to +212F)
Casting Temp. : -29C to +260C(-20F to +500F)

Size	Max Operating PSI (70F)	Weight (lbs)	Std Pack Qty	Part #
1/2"	250	0.26	100	CDC-050-DP
3/4"	250	0.42	50	CDC-075-DP
1"	250	0.80	60	CDC-100-DP
1-1/4"	250	0.95	40	CDC-125-DP
1-1/2"	250	1.00	40	CDC-150-DP
2"	250	1.30	24	CDC-200-DP
3"	100	1.65	12	CDC-300-DP
4"	100	4.00	10	CDC-400-DP
6"	75	7.90	6	CDC-600-DP



- Air and General Purpose Hose
- Water Suction and Discharge Hose
- Petroleum, Steam and Chemical Hose
- Rubber Material Handling Hose
- Plastic Material Handling Hose
- Food Hose
- Ducting
- Auto Truck and Marine Hose
- Fire Hose
- Welding and Other Hose
- Cam and Groove
- Nipples Menders and Shank Fittings
- Clamps
- High Pressure Fittings
- Mine Fittings
- Air Fittings
- Valves
- Sandblast
- Fire Fittings
- Pipe Fittings
- Sheet Rubber
- Index and Technical Information

Air and General Purpose Hose

Water Suction and Discharge Hose

Petroleum, Steam and Chemical Hose

Rubber Material Handling Hose

Plastic Material Handling Hose

Food Hose

Ducting

Auto Truck and Marine Hose

Fire Hose

Welding and Other Hose

Cam and Groove

Nipples, Menders and Shank Fittings

Clamps

High Pressure Fittings

Mine Fittings

Air Fittings

Valves

Sandblast

Fire Fittings

Pipe Fittings

Sheet Rubber

Index and Technical Information

DUST CAP STAINLESS 316

Vacuum Rating : FULL
Gasket Material : NBR
Gasket Temp. : -40C to +100C(-40F to +212F)
Casting Temp. : -101C to +260C(-150F to +500F)



FEMALE COUPLER

Size	Max Operating PSI (70F)	Weight (lbs)	Std Pack Qty	Part #
1/2"	250	0.35	100	CDC-050-SS1
3/4"	250	0.40	50	CDC-075-SS1
1"	250	0.62	50	CDC-100-SS1
1-1/4"	250	1.16	40	CDC-125-SS1
1-1/2"	250	1.12	40	CDC-150-SS1
2"	250	1.53	30	CDC-200-SS1
2-1/2"	200	2.29	20	CDC-250-SS1
3"	200	2.93	15	CDC-300-SS1
4"	100	4.45	10	CDC-400-SS1
5"	75	6.61	2	CDC-500-SS1
6"	75	10.13	2	CDC-600-SS1
8"	50	15.42	2	CDC-800-SS1

DUST CAP BRASS

Vacuum Rating : FULL
Gasket Material : NBR
Gasket Temp. : -40C to +100C(-40F to +212F)
Casting Temp. : -101C to +232C(-150F to +450F)



FEMALE COUPLER

Size	Max Operating PSI (70F)	Weight (lbs)	Std Pack Qty	Part #
1/2"	250	0.30	100	CDC-050-B1
3/4"	250	0.49	50	CDC-075-B1
1"	250	0.92	60	CDC-100-B1
1-1/4"	250	1.02	40	CDC-125-B1
1-1/2"	250	1.08	40	CDC-150-B1
2"	250	1.33	24	CDC-200-B1
2-1/2"	150	1.96	24	CDC-250-B1
3"	125	2.70	12	CDC-300-B1
4"	100	4.23	10	CDC-400-B1
5"	75	6.27	5	CDC-500-B1
6"	75	8.75	4	CDC-600-B1

DUST CAP ALUMINUM WITH STAINLESS HANDLES

Vacuum Rating : FULL
Gasket Material : NBR
Gasket Temp. : -40C to +100C(-40F to +212F)
Casting Temp. : -101C to +121C(-150F to +250F)



Size	Max Operating PSI (70F)	Weight (lbs)	Std Pack Qty	Part #
1/2"	250	0.12	100	CDC-050-A1S
3/4"	250	0.24	50	CDC-075-A1S
1"	250	0.37	50	CDC-100-A1S
1-1/4"	250	0.44	40	CDC-125-A1S
1-1/2"	250	0.69	40	CDC-150-A1S
2"	250	0.83	30	CDC-200-A1S
2-1/2"	150	0.98	20	CDC-250-A1S
3"	125	1.48	15	CDC-300-A1S
4"	100	2.29	10	CDC-400-A1S
5"	75	2.56	2	CDC-500-A1S
6"	75	5.13	2	CDC-600-A1S

DUST CAP POLY

Vacuum Rating : FULL
Gasket Material : EPDM
Gasket Temp. : -51C to +100C(-60F to +212F)
Casting Temp. : -26C to +66C(-15F to +150F)

Size	Max Operating PSI (70F)	Weight (lbs)	Std Pack Qty	Part #
1/2"	125	0.17	100	CDC-050-PP
3/4"	125	0.20	50	CDC-075-PP
1"	125	0.20	50	CDC-100-PP
1-1/4"	125	0.51	40	CDC-125-PP
1-1/2"	125	0.48	40	CDC-150-PP
2"	125	0.52	30	CDC-200-PP
3"	100	1.10	15	CDC-300-PP
4"	50	1.01	10	CDC-400-PP
4"	50	1.01	20	CDC-400-PP2



- Air and General Purpose Hose
- Water Suction and Discharge Hose
- Petroleum, Steam and Chemical Hose
- Rubber Material Handling Hose
- Plastic Material Handling Hose
- Food Hose
- Ducting
- Auto Truck and Marine Hose
- Fire Hose
- Welding and Other Hose
- Cam and Groove
- Nipples Menders and Shank Fittings
- Clamps
- High Pressure Fittings
- Mine Fittings
- Air Fittings
- Valves
- Sandblast
- Fire Fittings
- Pipe Fittings
- Sheet Rubber
- Index and Technical Information

Air and General Purpose Hose

Water Suction and Discharge Hose

Petroleum, Steam and Chemical Hose

Rubber Material Handling Hose

Plastic Material Handling Hose

Food Hose

Ducting

Auto Truck and Marine Hose

Fire Hose

Welding and Other Hose

Cam and Groove

Nipples, Menders and Shank Fittings

Clamps

High Pressure Fittings

Mine Fittings

Air Fittings

Valves

Sandblast

Fire Fittings

Pipe Fittings

Sheet Rubber

Index and Technical Information

DUST CAP NYLON GLASS

Vacuum Rating : FULL
Gasket Material : EPDM
Gasket Temp. : -51C to +100C(-60F to +212F)
Casting Temp. : -34C to +121C(-30F to +250F)

	Size	Max Operating PSI (70F)	Weight (lbs)	Std Pack Qty	Part #
 <p>FEMALE COUPLER</p>	1/2"	175	0.18	100	CDC-050-NY
	3/4"	175	0.16	50	CDC-075-NY
	1"	175	0.23	50	CDC-100-NY
	1-1/4"	150	0.50	40	CDC-125-NY
	1-1/2"	150	0.47	40	CDC-150-NY
	2"	125	0.49	30	CDC-200-NY
	3"	100	0.93	15	CDC-300-NY
	4"	50	1.00	10	CDC-400-NY
	4"	50	1.00	10	CDC-400-NY2

DUST CAP ALUMINUM LOCKING

Vacuum Rating : FULL
Gasket Material : NBR
Gasket Temp. : -40C to +100C(-40F to +212F)
Casting Temp. : -101C to +121C(-150F to +250F)

	Size	Max Operating PSI (70F)	Weight (lbs)	Std Pack Qty	Part #
 <p>FEMALE COUPLER</p>	1-1/2"	250	0.68	40	CDCL-150-A
	2"	250	0.82	24	CDCL-200-A
	2-1/2"	150	0.98	24	CDCL-250-A
	3"	125	1.47	30	CDCL-300-A
	4"	100	2.28	18	CDCL-400-A
	6"	75	4.14	6	CDCL-600-A

DUST CAP LOCKING STAINLESS 316

Vacuum Rating : FULL
Gasket Material : NBR
Gasket Temp. : -40C to +100C(-40F to +212F)
Casting Temp. : -101C to +260C(-150F to +500F)



FEMALE COUPLER

Size	Max Operating PSI (70F)	Weight (lbs)	Std Pack Qty	Part #
1-1/2"	250	1.56	40	CDCL-150-SS
2"	250	1.97	24	CDCL-200-SS
2-1/2"	200	2.42	24	CDCL-250-SS
3"	200	2.93	12	CDCL-300-SS
4"	100	5.64	10	CDCL-400-SS
6"	75	11.19	5	CDCL-600-SS

DUST CAP ALUMINUM QUICKKLOK

Vacuum Rating : FULL
Gasket Material : NBR
Gasket Temp. : -40C to +100C(-40F to +212F)
Casting Temp. : -101C to +121C(-150F to +250F)

Size	Max Operating PSI (70F)	Weight (lbs)	Std Pack Qty	Part #
1"	250	0.36	50	CDCHK-100-A1
1-1/2"	250	1.12	40	CDCHK-150-A1
2"	250	1.26	30	CDCHK-200-A1
2-1/2"	150	1.64	20	CDCHK-250-A1
3"	125	2.13	15	CDCHK-300-A1
4"	100	2.94	10	CDCHK-400-A1



FEMALE COUPLER

DUST CAP STAINLESS 316 QUICKKLOK

Vacuum Rating : FULL
Gasket Material : NBR
Gasket Temp. : -40C to +100C(-40F to +212F)
Casting Temp. : -101C to +260C(-150F to +500F)

Size	Max Operating PSI (70F)	Weight (lbs)	Std Pack Qty	Part #
1"	250	1.06	60	CDCK-100-SS
1-1/2"	250	1.69	30	CDCK-150-SS
2"	250	2.14	24	CDCK-200-SS
2-1/2"	200	2.94	10	CDCK-250-SS
3"	200	3.92	12	CDCK-300-SS
4"	100	5.27	10	CDCK-400-SS



FEMALE COUPLER

Air and General Purpose Hose

Water Suction and Discharge Hose

Petroleum, Steam and Chemical Hose

Rubber Material Handling Hose

Plastic Material Handling Hose

Food Hose

Ducting

Auto Truck and Marine Hose

Fire Hose

Welding and Other Hose

Cam and Groove

Nipples, Menders and Shank Fittings

Clamps

High Pressure Fittings

Mine Fittings

Air Fittings

Valves

Sandblast

Fire Fittings

Pipe Fittings

Sheet Rubber

Index and Technical Information

Air and General Purpose Hose

DUST CAP BRASS QUICKKLOK

Vacuum Rating : FULL
Gasket Material : NBR
Gasket Temp. : -40C to +100C(-40F to +212F)
Casting Temp. : -101C to +232C(-150F to +450F)

Size	Max Operating PSI (70F)	Weight (lbs)	Std Pack Qty	Part #
1-1/2"	250	1.52	40	CDCHK-150-B1
2"	250	1.77	30	CDCHK-200-B1
2-1/2"	150	1.97	20	CDCHK-250-B1
3"	125	3.36	15	CDCHK-300-B1
4"	100	4.89	10	CDCHK-400-B1



Petroleum, Steam and Chemical Hose

Rubber Material Handling Hose

Plastic Material Handling Hose

Food Hose

DUST CAP ALUMINUM + CHAIN

Vacuum Rating : FULL
Gasket Material : NBR
Gasket Temp. : -40C to +100C(-40F to +212F)
Casting Temp. : -101C to +121C(-150F to +250F)

Size	Max Operating PSI (70F)	Weight (lbs)	Std Pack Qty	Part #
1-1/2"	250	0.71	40	CDCWC-150-A1
2"	250	0.85	30	CDCWC-200-A1
2-1/2"	150	1.01	20	CDCWC-250-A1
3"	125	1.52	15	CDCWC-300-A1
4"	100	2.33	10	CDCWC-400-A1
5"	75	2.62	2	CDCWC-500-A1
6"	75	4.27	2	CDCWC-600-A1

Ducting

Auto Truck and Marine Hose

Fire Hose

Welding and Other Hose

Cam and Groove

Nipples, Menders and Shank Fittings

Clamps

High Pressure Fittings

Mine Fittings

Air Fittings

Valves

Sandblast

Fire Fittings

Pipe Fittings

Sheet Rubber

Index and Technical Information

Safety Information : NOT FOR USE WITH COMPRESSED GASES

DUST PLUG ALUMINUM

Casting Temp. : -101C to +121C(-150F to +250F)



MALE ADAPTER

Size	Weight (lbs)	Std Pack Qty	Part #
1/2"	0.04	100	CDP-050-A1
3/4"	0.10	50	CDP-075-A1
1"	0.10	50	CDP-100-A1
1 1/4"	10.80	3	CDP-1000-A
1-1/2"	0.22	50	CDP-125-A1
2"	0.37	50	CDP-150-A1
2-1/2"	0.39	50	CDP-200-A1
3"	0.47	25	CDP-250-A1
4"	0.71	25	CDP-300-A1
5"	1.23	15	CDP-400-A1
6"	1.54	2	CDP-500-A1
8"	1.98	2	CDP-600-A1
	4.41	6	CDP-800-A1

DUST PLUG STAINLESS 316

Casting Temp. : -101C to +260C(-150F to +500F)

Size	Weight (lbs)	Std Pack Qty	Part #
1/2"	0.13	100	CDP-050-SS1
3/4"	0.31	50	CDP-075-SS1
1"	0.37	50	CDP-100-SS1
1-1/4"	0.51	50	CDP-125-SS1
1-1/2"	0.73	50	CDP-150-SS1
2"	1.11	50	CDP-200-SS1
2-1/2"	1.76	25	CDP-250-SS1
3"	2.12	25	CDP-300-SS1
4"	3.77	15	CDP-400-SS1
5"	4.50	2	CDP-500-SS1
6"	5.23	2	CDP-600-SS1
8"	11.60	4	CDP-800-SS1



MALE ADAPTER

- Air and General Purpose Hose
- Water Suction and Discharge Hose
- Petroleum, Steam and Chemical Hose
- Rubber Material Handling Hose
- Plastic Material Handling Hose
- Food Hose
- Ducting
- Auto Truck and Marine Hose
- Fire Hose
- Welding and Other Hose
- Cam and Groove
- Nipples Menders and Shank Fittings
- Clamps
- High Pressure Fittings
- Mine Fittings
- Air Fittings
- Valves
- Sandblast
- Fire Fittings
- Pipe Fittings
- Sheet Rubber
- Index and Technical Information

Air and General Purpose Hose

DUST PLUG DUCTILE IRON

Casting Temp. : -29C to +260C(-20F to +500F)



MALE ADAPTER

Size	Weight (lbs)	Std Pack Qty	Part #
1/2"	0.17	100	CDP-050-DP
3/4"	0.32	50	CDP-075-DP
1"	0.31	60	CDP-100-DP
1-1/4"	0.50	60	CDP-125-DP
1-1/2"	0.65	60	CDP-150-DP
2"	0.73	40	CDP-200-DP
3"	1.24	24	CDP-300-DP
4"	2.30	12	CDP-400-DP
6"	5.50	6	CDP-600-DP

Water Suction and Discharge Hose

Petroleum, Steam and Chemical Hose

Rubber Material Handling Hose

Plastic Material Handling Hose

Food Hose

DUST PLUG BRASS

Casting Temp. : -101C to +232C(-150F to +450F)

Size	Weight (lbs)	Std Pack Qty	Part #
1/2"	0.17	100	CDP-050-B1
3/4"	0.29	50	CDP-075-B1
1"	0.37	60	CDP-100-B1
1-1/4"	0.63	60	CDP-125-B1
1-1/2"	0.53	60	CDP-150-B1
2"	0.87	40	CDP-200-B1
2-1/2"	1.45	30	CDP-250-B1
3"	1.47	24	CDP-300-B1
4"	2.86	12	CDP-400-B1
5"	5.53	10	CDP-500-B1
6"	5.98	8	CDP-600-B1



MALE ADAPTER

Ducting

Auto Truck and Marine Hose

Fire Hose

Welding and Other Hose

Cam and Groove

Nipples, Menders and Shank Fittings

Clamps
High Pressure Fittings

Mine Fittings

DUST PLUG NYLON GLASS

Casting Temp. : -34C to +121C(-30F to +250F)



MALE ADAPTER

Size	Weight (lbs)	Std Pack Qty	Part #
1/2"	0.02	100	CDP-050-NY
3/4"	0.05	50	CDP-075-NY
1"	0.05	50	CDP-100-NY
1-1/4"	0.11	50	CDP-125-NY
1-1/2"	0.13	50	CDP-150-NY
2"	0.40	50	CDP-200-NY
3"	0.50	25	CDP-300-NY
4"	0.60	15	CDP-400-NY

Air Fittings

Valves

Sandblast

Fire Fittings

Pipe Fittings

Sheet Rubber

Index and Technical Information

DUST PLUG POLY

Casting Temp. : -26C to +66C(-15F to +150F)

Size	Weight (lbs)	Std Pack Qty	Part #
1/2"	0.04	100	CDP-050-PP
3/4"	0.05	50	CDP-075-PP
1"	0.06	50	CDP-100-PP
1-1/4"	0.07	50	CDP-125-PP
1-1/2"	0.14	50	CDP-150-PP
2"	0.15	50	CDP-200-PP
3"	0.49	25	CDP-300-PP
4"	0.62	15	CDP-400-PP



MALE ADAPTER

Air and General Purpose Hose

Water Suction and Discharge Hose

Petroleum, Steam and Chemical Hose

Rubber Material Handling Hose

Plastic Material Handling Hose

Food Hose

Ducting

Auto Truck and Marine Hose

Fire Hose

Welding and Other Hose

Cam and Groove

Nipples, Menders and Shank Fittings

Clamps

High Pressure Fittings

Mine Fittings

Air Fittings

Valves

Sandblast

Fire Fittings

Pipe Fittings

Sheet Rubber

Index and Technical Information

HANDLE+PIN+RING BRASS



Description	Weight (lbs)	Part #
1/2"& 3/4"HANDLE+PIN BRASS	0.04	HF-075-BCC
1" HANDLE+PIN+RING BRASS	0.07	HF-100-BCC
1-1/4"-2-1/2"HANDL+PIN+RING BRASS	0.15	HF-200-BCC
3"-5"HANDLE+PIN+RING BRASS	0.20	HF-300-BCC
6"-8" HANDLE+PIN+RING BRASS	0.57	HF-600-BCC

Product Information : Brass handles are forged.

HANDLE+PIN+RING STAINLESS



Description	Weight (lbs)	Part #
12"STAINLESS CHAIN+ S HOOKS	0.05	CH-12-SS
6" STAINLESS CHAIN + S HOOKS	0.03	CH-6-SS
STAINLESS PIN FOR 3/4" CAMLOCK	0.01	HP-075-SS
STAINLESS PIN FOR 1" CAMLOCK	0.01	HP-100-SS
STAINLESS PIN FOR 1-1/4"-2-1/2"CAMLOCK	0.01	HP-200-SS
STAINLESS PIN FOR 3-5" CAMLOCKS	0.01	HP-300-SS
STAINLESS PIN FOR 6" CAMLOCK	0.01	HP-600-SS
1/2"--1-1/2"STAINLESS CAMLOCK RINGS	0.01	HR-150-SS
2"--6" STAINLESS CAMLOCK RING	0.01	HR-400-SS
1/2"& 3/4"HANDLE+PIN+RING STAIN.	0.04	HS-075-SS
1" HANDLE+PIN+RING STAINLESS	0.07	HS-100-SS
1-1/4"-2-1/2"HANDL+PIN+RING STAIN.	0.15	HS-200-SS
3"-5"HANDLE+PIN+RING STAINLESS	0.33	HS-300-SS
6"-8" HANDLE+PIN+RING STAINLESS	0.44	HS-600-SS
1-1/4"-2-1/2"REVERSED HANDL+PIN+RING STA	0.15	HSC-200-SS

Product Information : Stainless handles are Premium quality unbreakable Investment Cast

Air and General Purpose Hose
 Water Suction and Discharge Hose
 Petroleum, Steam and Chemical Hose
 Rubber Material Handling Hose
 Plastic Material Handling Hose
 Food Hose
 Ducting
 Auto Truck and Marine Hose
 Fire Hose
 Welding and Other Hose
 Cam and Groove
 Nipples, Menders and Shank Fittings
 Clamps
 High Pressure Fittings
 Mine Fittings
 Air Fittings
 Valves
 Sandblast
 Fire Fittings
 Pipe Fittings
 Sheet Rubber
 Index and Technical Information

LOCKING HANDLE BRASS FOR CAMLOCK



Description	Weight (lbs)	Part #
LOCKING HANDLE BRS FOR 1-1/4"-2-1/2"CAML	0.20	HSL-200-B
LOCKING HANDLE BRASS FOR 3"&4"CAMLOCK	0.30	HSL-300-B
LOCKING HANDLE BRASS FOR 6"CAMLOCK	0.50	HSL-600-B

Product Information : Brass handles are forged.

LOCKING HANDLE STAINLESS FOR CAMLOCK



Description	Weight (lbs)	Part #
LOCKING HANDLE SS FOR 1-1/4"-2-1/2"CAMLC	0.22	HSL-200-SS
LOCKING HANDLE STAIN.FOR 3"&4"CAMLOCK	0.35	HSL-300-SS
LOCKING HANDLE STAINL.FOR 6"CAMLOCK	0.53	HSL-600-SS

Product Information : Stainless handles are Premium quality unbreakable Investment Cast

QUICKKOK HANDLE FOR ALUMINUM, BRASS AND STAINLESS



Description	Weight (lbs)	Part #
QUICKKOK HANDLE FOR AL/BRASS 1-1/2"-2"	0.22	HSK2-200-SS
QUICKKOK HANDLE FOR AL/BRASS 3"&4"	0.33	HSK2-300-SS

Product Information : Stainless handles are Premium quality unbreakable Investment Cast

H PIECE FOR SELFLOCK HANDLE



Description	Part #
H PIECE FOR 1-1/4"-2-1/2"SELF-LOCK HANDL	HHK2-200-SS
H PIECE FOR 3" & 4"SELF-LOCK HANDLE	HHK2-300-SS

LOCKING SAFETY CLIP FOR CAMS

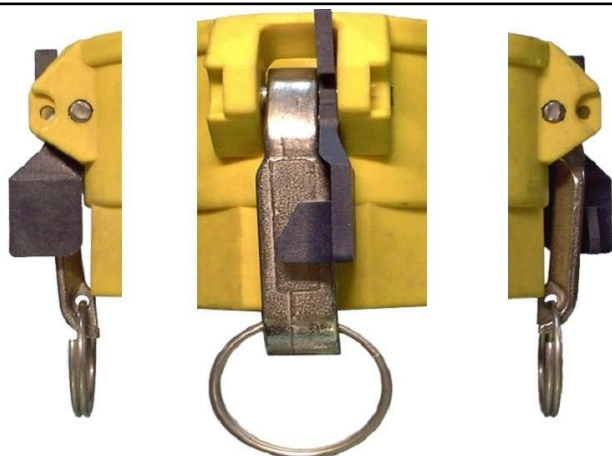

Description	Part #
YELLOW PLASTIC SAFETY CLIP FOR 1" CAMS	PH-100-NY
YELLOW PLASTIC CLIP FOR 1-1/4"-2-1/2"CAM	PH-200-NY
YELLOW PLASTIC SAFETY CLIP FOR 3"&4"CAMS	PH-300-NY

- Air and General Purpose Hose
- Water Suction and Discharge Hose
- Petroleum, Steam and Chemical Hose
- Rubber Material Handling Hose
- Plastic Material Handling Hose
- Food Hose
- Ducting
- Auto Truck and Marine Hose
- Fire Hose
- Welding and Other Hose
- Cam and Groove
- Nipples Menders and Shank Fittings
- Clamps
- High Pressure Fittings
- Mine Fittings
- Air Fittings
- Valves
- Sandblast
- Fire Fittings
- Pipe Fittings
- Sheet Rubber
- Index and Technical Information

Air and
General
Purpose
Hose

CAMLOCK GASKET EPDM

	Description	Weight (lbs)	Part #
Water Suction and Discharge Hose	1/2" CAMLOCK GASKET EPDM	0.01	CG-050-EPDM
	3/4" CAMLOCK GASKET EPDM	0.01	CG-075-EPDM
Petroleum, Steam and Chemical Hose	1" CAMLOCK GASKET EPDM	0.01	CG-100-EPDM
	1-1/4" CAMLOCK GASKET EPDM	0.01	CG-125-EPDM
	1-1/2" CAMLOCK GASKET EPDM	0.01	CG-150-EPDM
Rubber Material Handling Hose	2" CAMLOCK GASKET EPDM	0.02	CG-200-EPDM
	2-1/2" CAMLOCK GASKET EPDM	0.02	CG-250-EPDM
	3" CAMLOCK GASKET EPDM	0.05	CG-300-EPDM
Plastic Material Handling Hose	4" CAMLOCK GASKET EPDM	0.08	CG-400-EPDM
	5" CAMLOCK GASKET EPDM	0.09	CG-500-EPDM
Food Hose	6" CAMLOCK GASKET EPDM	0.11	CG-600-EPDM
Ducting	8" CAMLOCK GASKET EPDM	0.15	CG-800-EPDM

Auto
Truck and
Marine
Hose

CAMLOCK GASKET NBR

	Description	Weight (lbs)	Part #
Fire Hose	1/2" CAMLOCK GASKET NBR	0.01	CG-050-NBR
Welding and Other Hose	3/4" CAMLOCK GASKET NBR	0.01	CG-075-NBR
Cam and Groove	1" CAMLOCK GASKET NBR	0.01	CG-100-NBR
	10" CAMLOCK GASKET NBR	0.18	CG-1000-NBR
Nipples Menders and Shank Fittings	1-1/4" CAMLOCK GASKET NBR	0.01	CG-125-NBR
	1-1/2" CAMLOCK GASKET NBR	0.01	CG-150-NBR
	2" CAMLOCK GASKET NBR	0.02	CG-200-NBR
Clamps	2-1/2" CAMLOCK GASKET NBR	0.03	CG-250-NBR
High Pressure Fittings	3" CAMLOCK GASKET NBR	0.05	CG-300-NBR
	4" CAMLOCK GASKET NBR	0.08	CG-400-NBR
Mine Fittings	5" CAMLOCK GASKET NBR	0.09	CG-500-NBR
Air Fittings	6" CAMLOCK GASKET NBR	0.11	CG-600-NBR
Valves	8" CAMLOCK GASKET NBR	0.15	CG-800-NBR

Sandblast

Fire
Fittings

Pipe
Fittings

Sheet
Rubber

Index
and
Technical
Information

CAMLOCK GASKET VITON

Description	Weight (lbs)	Part #
1/2" CAMLOCK GASKET VITON	0.01	CG-050-VI
3/4" CAMLOCK GASKET VITON	0.01	CG-075-VI
1" CAMLOCK GASKET VITON	0.01	CG-100-VI
1-1/4" CAMLOCK GASKET VITON	0.01	CG-125-VI
1-1/2" CAMLOCK GASKET VITON	0.01	CG-150-VI
2" CAMLOCK GASKET VITON	0.02	CG-200-VI
2-1/2" CAMLOCK GASKET VITON	0.03	CG-250-VI
3" CAMLOCK GASKET VITON	0.05	CG-300-VI
4" CAMLOCK GASKET VITON	0.08	CG-400-VI

Air and General Purpose Hose

Water Suction and Discharge Hose

Petroleum, Steam and Chemical Hose

Rubber Material Handling Hose

Plastic Material Handling Hose

CAMLOCK GASKET WHITE NBR

Description	Weight (lbs)	Part #
1-1/2" CAMLOCK GASKET WHITE NBR	0.01	CG-150-WH
2" CAMLOCK GASKET WHITE NBR	0.02	CG-200-WH
2-1/2" CAMLOCK GASKET WHITE NBR	0.03	CG-250-WH
3" CAMLOCK GASKET WHITE NBR	0.05	CG-300-WH
4" CAMLOCK GASKET WHITE NBR	0.08	CG-400-WH
5" CAMLOCK GASKET WHITE NBR	0.09	CG-500-WH
6" CAMLOCK GASKET WHITE NBR	0.11	CG-600-WH

Food Hose

Ducting

Auto Truck and Marine Hose

Fire Hose

Welding and Other Hose

Cam and Groove

Nipples, Menders and Shank Fittings

TEFLON ENCAPSULATED SILICONE GASKET

Description	Weight (lbs)	Part #
1-1/2"TEFLON ENCAPS.SILICONE GASKET	0.01	CG-150-TES
2"TEFLON ENCAPSULATED SILICONE GASKET	0.02	CG-200-TES
2-1/2"TEFLON ENCAPS.SILICONE GASKET	0.03	CG-250-TES
3"TEFLON ENCAPSULATED SILICONE GASKET	0.05	CG-300-TES
4"TEFLON ENCAPSULATED SILICONE GASKET	0.08	CG-400-TES

Clamps

High Pressure Fittings

Mine Fittings

Air Fittings

Valves

Sandblast

Fire Fittings

Pipe Fittings

Sheet Rubber

Index and Technical Information

Air and
General
Purpose
Hose

TEFLON ENCAPSULATED VITON GASKET

Description	Weight (lbs)	Part #
1"TEFLON ENCAPSULATED VITON GASKET	0.01	CG-100-TEV
1-1/2"TEFLON ENCAPSULATED VITON GASKET	0.01	CG-150-TEV
2"TEFLON ENCAPSULATED VITON GASKET	0.02	CG-200-TEV
3"TEFLON ENCAPSULATED VITON GASKET	0.05	CG-300-TEV
4"TEFLON ENCAPSULATED VITON GASKET	0.08	CG-400-TEV

Water
Suction
and
Discharge
Hose

Petroleum,
Steam and
Chemical
Hose

Rubber
Material
Handling
Hose

TEFLON ENVELOPED BUNA OR VITON CAM GASKET

Description	Weight (lbs)	Part #
3/4"TEFLON ENVELOPED BUNA CAML.GASKET	0.03	CG-075-TB
1"TEFLON ENVELOPED BUNA CAML.GASKET	0.01	CG-100-TB
1"TEFLON ENVELOPED VITON CAML.GASKET	0.01	CG-100-TV
1-1/2"TEFLON ENVELOPE BUNA CAML.GASKET	0.01	CG-150-TB
1-1/2"TEFLON ENVELOPE VITON CAM.GASKET	0.01	CG-150-TV
2" TEFLON ENVELOPED BUNA CAML.GASKET	0.02	CG-200-TB
2"TEFLON ENVELOPED VITON CAML.GASKET	0.02	CG-200-TV
2-1/2"TEFLON ENVELOP.BUNA CAML.GASKET	0.03	CG-250-TB
3" TEFLON ENVELOPED BUNA CAML.GASKET	0.00	CG-300-TB
3"TEFLON ENVELOPE VITON CAML.GASKET	0.05	CG-300-TV
4"TEFLON ENVELOPE VITON CAML.GASKET	0.08	CG-400-TV
6"TEFLON ENVELOPE VITON CAML.GASKET	0.13	CG-600-TV

Plastic
Material
Handling
Hose

Food Hose

Ducting

Auto
Truck and
Marine
Hose

Fire Hose

Welding
and
Other Hose

Cam
and
Groove

Nipples
Menders
and
Shank
Fittings

Clamps

TEFLON ENVELOPED NEOPRENE CAM GASKET

Description	Weight (lbs)	Part #
4" TEFLON ENVELOPED NEO CAML.GASKET	0.08	CG-400-TN

High
Pressure
Fittings

Mine
Fittings

Air
Fittings

Valves

Sandblast

Fire
Fittings

Pipe
Fittings

Sheet
Rubber

Index
and
Technical
Information

GARDEN HOSE CAM AND GROOVE

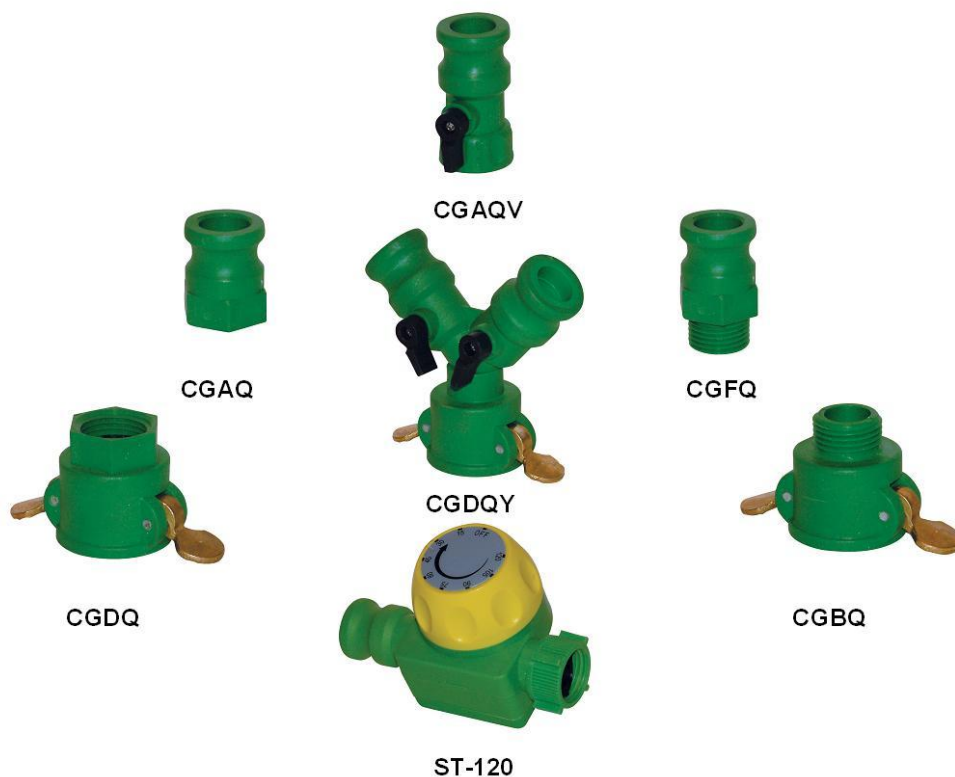

Application : Mainly for residential use but can also be used for commercial water hose applications. These cam and groove fittings mate with fittings that feature GHT (Garden Hose Thread). They are made from UV resistant polypropylene and feature brass arms and EPDM gaskets. They can be configured in many different ways to create a quick connect system for all your garden implements.

Vacuum Rating : FULL
Gasket Material : EPDM
Casting Temp. : -26C to +66C(-15F to +150F)
Gasket Temp. : -51C to +100C(-60F to +212F)

Description	Weight (lbs)	Part #
3/4" PART A POLY GREEN GHT THREAD	0.04	CGAQ-075-PP
3/4" PART A POLY GRN GHT W ON/OFF	0.04	CGAQV-075-PP
3/4" PART B POLY GREEN GHT THREAD	0.16	CGBQ-075-PP
3/4" PART D POLY GREEN GHT THREAD	0.20	CGDQ-075-PP
3/4" PART D POLY GRN GHT Y W ON/OFF	0.20	CGDQY-075-PP
3/4" PART F POLY GREEN GHT THREAD	0.07	CGFQ-075-PP
SELF TIMER FOR POLY GREEN GHT	0.20	ST-120

Air and General Purpose Hose
 Water Suction and Discharge Hose
 Petroleum, Steam and Chemical Hose
 Rubber Material Handling Hose
 Plastic Material Handling Hose
 Food Hose
 Ducting
 Auto Truck and Marine Hose
 Fire Hose
 Welding and Other Hose
 Cam and Groove
 Nipples Menders and Shank Fittings
 Clamps
 High Pressure Fittings
 Mine Fittings
 Air Fittings
 Valves
 Sandblast
 Fire Fittings
 Pipe Fittings
 Sheet Rubber
 Index and Technical Information

COMBINATION NIPPLE



Safety Information : Combination nipples are not suitable for use on Steam and Air hose. High pressure couplings should be used for these types of hose. Consult us for the best type of clamp to use with various hose when attaching combination nipples. We do not recommend using gear clamps on hose above 1/2" and pressures in excess of 100 psi. We do not recommend that combination nipples be used at pressures over 150 psi on sizes up to 1" I.D., and over 100 psi on sizes above 1".

COMBINATION NIPPLE PLAIN NPT



Size	Weight (lbs)	Std Pack Qty	Part #
1/2"	0.17	400	CNT-050-S
3/4"	0.22	200	CNT-075-S
1"	0.40	100	CNT-100-S
1-1/4"	0.49	80	CNT-125-S
1-1/2"	0.70	60	CNT-150-S
2"	1.01	50	CNT-200-S
2-1/2"	1.60	20	CNT-250-S
3"	2.00	20	CNT-300-S
4"	3.85	12	CNT-400-S
5"	8.80	4	CNT-500-S
6"	12.10	4	CNT-600-S
8"	24.20	2	CNT-800-S
10"	35.20	1	CNT-1000-S
12"	50.60	1	CNT-1200-S

- Air and General Purpose Hose
- Water Suction and Discharge Hose
- Petroleum, Steam and Chemical Hose
- Rubber Material Handling Hose
- Plastic Material Handling Hose
- Food Hose
- Ducting
- Auto Truck and Marine Hose
- Fire Hose
- Welding and Other Hose
- Cam and Groove
- Nipples Menders and Shank Fittings
- Clamps
- High Pressure Fittings
- Mine Fittings
- Air Fittings
- Valves
- Sandblast
- Fire Fittings
- Pipe Fittings
- Sheet Rubber
- Index and Technical Information

Air and General Purpose Hose

COMBINATION NIPPLE PLATED

Water Suction and Discharge Hose

Petroleum, Steam and Chemical Hose

Rubber Material Handling Hose

Plastic Material Handling Hose

Food Hose

Ducting

Auto Truck and Marine Hose



Size	Weight (lbs)	Std Pack Qty	Part #
1/2"	0.17	400	CNT-050-SP
3/4"	0.22	200	CNT-075-SP
1"	0.40	100	CNT-100-SP
1-1/4"	0.49	80	CNT-125-SP
1-1/2"	0.70	60	CNT-150-SP
2"	1.01	50	CNT-200-SP
2-1/2"	1.60	20	CNT-250-SP
3"	2.00	20	CNT-300-SP
4"	3.85	12	CNT-400-SP
5"	8.80	4	CNT-500-SP
6"	12.10	4	CNT-600-SP
8"	24.20	2	CNT-800-SP
10"	35.20	1	CNT-1000-SP
12"	50.60	1	CNT-1200-SP

Fire Hose

COMBINATION NIPPLE 304 STAINLESS

Welding and Other Hose

Cam and Groove

Nipples, Menders and Shank Fittings

Clamps

High Pressure Fittings

Mine Fittings

Air Fittings

Valves

Sandblast

Fire Fittings

Pipe Fittings

Sheet Rubber

Index and Technical Information

Size	Weight (lbs)	Std Pack Qty	Part #
1/2"	0.15	300	CNT-050-SS
3/4"	0.20	200	CNT-075-SS
1"	0.37	100	CNT-100-SS
1-1/4"	0.52	80	CNT-125-SS
1-1/2"	0.66	60	CNT-150-SS
2"	1.08	50	CNT-200-SS
2-1/2"	1.76	20	CNT-250-SS
3"	2.50	20	CNT-300-SS
4"	4.10	12	CNT-400-SS
5"	9.10	4	CNT-500-SS
6"	12.20	4	CNT-600-SS
8"	25.00	1	CNT-800-SS



COMBINATION NIPPLE 316 STAINLESS



Size	Weight (lbs)	Std Pack Qty	Part #
1/2"	0.15	300	CNT-050-SS316
3/4"	0.25	200	CNT-075-SS316
1"	0.40	100	CNT-100-SS316
1-1/4"	0.55	80	CNT-125-SS316
1-1/2"	0.68	60	CNT-150-SS316
2"	1.20	50	CNT-200-SS316
3"	3.00	20	CNT-300-SS316
4"	3.30	12	CNT-400-SS316
6"	12.00	4	CNT-600-SS316

Air and General Purpose Hose

Water Suction and Discharge Hose

Petroleum, Steam and Chemical Hose

Rubber Material Handling Hose

Plastic Material Handling Hose

COMBINATION NIPPLE ALUMINUM

Size	Weight (lbs)	Std Pack Qty	Part #
3/4"	0.09	200	CNT-075-A
1"	0.11	100	CNT-100-A
1-1/4"	0.20	80	CNT-125-A
1-1/2"	0.25	60	CNT-150-A
2"	0.40	50	CNT-200-A
2-1/2"	0.89	20	CNT-250-A
3"	1.32	20	CNT-300-A
4"	2.02	12	CNT-400-A



Food Hose

Ducting

Auto Truck and Marine Hose

Fire Hose

Welding and Other Hose

Cam and Groove

Nipples, Menders and Shank Fittings

COMBINATION NIPPLE BRASS



Size	Weight (lbs)	Std Pack Qty	Part #
1/2"	0.16	300	CNT-050-B
3/4"	0.23	200	CNT-075-B
1"	0.44	100	CNT-100-B
1-1/4"	0.66	80	CNT-125-B
1-1/2"	0.84	60	CNT-150-B
2"	1.28	50	CNT-200-B
2-1/2"	1.76	20	CNT-250-B
3"	2.20	20	CNT-300-B
4"	3.20	12	CNT-400-B

Clamps

High Pressure Fittings

Mine Fittings

Air Fittings

Valves

Sandblast

Fire Fittings

Pipe Fittings

Sheet Rubber

Index and Technical Information

Air and General Purpose Hose

COMBINATION NIPPLE POLY

Water Suction and Discharge Hose

Petroleum, Steam and Chemical Hose

Rubber Material Handling Hose

Plastic Material Handling Hose

Food Hose

Ducting

Auto Truck and Marine Hose

Fire Hose

Welding and Other Hose

Cam and Groove

Nipples, Menders and Shank Fittings

Clamps

High Pressure Fittings

Mine Fittings

Air Fittings

Valves

Sandblast

Fire Fittings

Pipe Fittings

Sheet Rubber

Index and Technical Information

Size	Weight (lbs)	Std Pack Qty	Part #
1/2"	0.03	400	CNT-050-PP
3/4"	0.04	200	CNT-075-PP
1"	0.07	100	CNT-100-PP
1-1/4"	0.09	80	CNT-125-PP
1-1/2"	0.16	60	CNT-150-PP
2"	0.22	40	CNT-200-PP
2-1/2"	0.33	6	CNT-250-PP
3"	0.62	12	CNT-300-PP
4"	1.21	6	CNT-400-PP



Safety Information : Maximum working pressure on sizes 1/2" to 2" is 100 PSI, 2-1/2",3" and 4" maximum working pressure is 75PSI.

COMBINATION NIPPLE PLAIN VICTAULIC GROOVED



Size	Weight (lbs)	Std Pack Qty	Part #
1-1/2"	0.70	60	CNG-150-S
2"	0.97	50	CNG-200-S
2-1/2"	2.00	20	CNG-250-S
3"	2.20	20	CNG-300-S
4"	3.85	12	CNG-400-S
6"	12.10	4	CNG-600-S
8"	24.20	2	CNG-800-S
10"	35.20	1	CNG-1000-S
12"	50.60	1	CNG-1200-S

COMBINATION NIPPLE PLATED VICTAULIC GROOVED

Size	Weight (lbs)	Std Pack Qty	Part #
1-1/2"	0.70	60	CNG-150-SP
2"	1.01	50	CNG-200-SP
2-1/2"	2.00	20	CNG-250-SP
3"	2.20	20	CNG-300-SP
4"	3.85	12	CNG-400-SP
5"	8.81	4	CNG-500-SP
6"	12.10	4	CNG-600-SP
8"	24.20	2	CNG-800-SP
10"	35.20	1	CNG-1000-SP
12"	50.60	1	CNG-1200-SP



COMBINATION NIPPLE 304 STAINLESS VICTAULIC GROOVED



Size	Weight (lbs)	Std Pack Qty	Part #
1/2"	0.17	400	CNG-050-SS
3/4"	0.22	200	CNG-075-SS
1"	0.38	100	CNG-100-SS
1-1/4"	0.58	80	CNG-125-SS
1-1/2"	0.76	60	CNG-150-SS
2"	1.21	50	CNG-200-SS
2-1/2"	2.20	20	CNG-250-SS
3"	2.64	20	CNG-300-SS
4"	4.03	12	CNG-400-SS
5"	9.00	4	CNG-500-SS
6"	11.00	4	CNG-600-SS
8"	25.00	2	CNG-800-SS

Air and General Purpose Hose

Water Suction and Discharge Hose

Petroleum, Steam and Chemical Hose

Rubber Material Handling Hose

Plastic Material Handling Hose

Food Hose

Ducting

Auto Truck and Marine Hose

Fire Hose

Welding and Other Hose

Cam and Groove

Nipples, Menders and Shank Fittings

Clamps

High Pressure Fittings

Mine Fittings

Air Fittings

Valves

Sandblast

Fire Fittings

Pipe Fittings

Sheet Rubber

Index and Technical Information

COMBINATION NIPPLE 316 STAINLESS VICTAULIC GROOVED

Size	Weight (lbs)	Std Pack Qty	Part #
2"	0.99	50	CNG-200-SS316
3"	2.20	20	CNG-300-SS316
4"	3.41	12	CNG-400-SS316
6"	12.11	4	CNG-600-SS316



COMBINATION NIPPLE PLATED LONG NPT



Size	Weight (lbs)	Std Pack Qty	Part #
2"	2.00	25	CNL-200-SP
2-1/2"	3.10	20	CNL-250-SP
3"	4.60	15	CNL-300-SP
4"	7.20	10	CNL-400-SP
6"	15.20	4	CNL-600-SP

COMBINATION NIPPLE PLATED LONG VICTAULIC GROOVED

Size	Weight (lbs)	Std Pack Qty	Part #
2"	2.00	25	CNLG-200-SP
3"	4.6	15	CNLG-300-SP
4"	7.2	10	CNLG-400-SP



Air and
General
Purpose
Hose

MENDER PLAIN



	Size	Weight (lbs)	Std Pack Qty	Part #
Water Suction and Discharge Hose	3/8"	.06	600	HM-038-S
	1/2"	0.09	400	HM-050-S
	5/8"	.17	400	HM-063-S
Petroleum, Steam and Chemical Hose	3/4"	0.25	200	HM-075-S
	1"	0.29	100	HM-100-S
Rubber Material Handling Hose	1-1/4"	0.48	100	HM-125-S
	1-1/2"	0.50	80	HM-150-S
	2"	0.72	70	HM-200-S
Plastic Material Handling Hose	2-1/2"	1.65	20	HM-250-S
	3"	2.20	15	HM-300-S
Food Hose	4"	3.92	9	HM-400-S
Ducting	5"	5.87	6	HM-500-S
	6"	13.22	4	HM-600-S
Auto Truck and Marine Hose	8"	20.93	2	HM-800-S
	10"	39.65	1	HM-1000-S
Fire Hose	12"	50.66	1	HM-1200-S

Welding
and
Other Hose

MENDER PLATED

	Size	Weight (lbs)	Std Pack Qty	Part #
Cam and Groove	3/8"	0.06	600	HM-038-SP
Nipples Menders and Shank Fittings	1/2"	0.09	400	HM-050-SP
	5/8"	.17	400	HM-063-SP
	3/4"	0.25	200	HM-075-SP
Clamps	1"	0.33	100	HM-100-SP
High Pressure Fittings	1-1/4"	0.48	100	HM-125-SP
	1-1/2"	0.50	80	HM-150-SP
Mine Fittings	2"	0.72	70	HM-200-SP
	2-1/2"	1.65	20	HM-250-SP
Air Fittings	3"	2.20	15	HM-300-SP
Valves	4"	3.67	9	HM-400-SP
Sandblast	5"	7.71	6	HM-500-SP
	6"	13.22	4	HM-600-SP
Fire Fittings	8"	20.93	2	HM-800-SP
Pipe Fittings	10"	39.65	1	HM-1000-SP
Sheet Rubber	12"	50.66	1	HM-1200-SP



Index
and
Technical
Information

MENDER 304 STAINLESS



Size	Weight (lbs)	Std Pack Qty	Part #
1/2"	0.11	200	HM-050-SS
3/4"	0.18	100	HM-075-SS
1"	0.33	100	HM-100-SS
1-1/4"	0.46	80	HM-125-SS
1-1/2"	0.55	60	HM-150-SS
2"	0.59	50	HM-200-SS
2-1/2"	1.35	20	HM-250-SS
3"	2.11	15	HM-300-SS
4"	3.61	9	HM-400-SS

Air and General Purpose Hose

Water Suction and Discharge Hose

Petroleum, Steam and Chemical Hose

Rubber Material Handling Hose

Plastic Material Handling Hose

Food Hose

Ducting

Auto Truck and Marine Hose

Fire Hose

Welding and Other Hose

Cam and Groove

Nipples Menders and Shank Fittings

Clamps

High Pressure Fittings

Mine Fittings

Air Fittings

Valves

Sandblast

Fire Fittings

Pipe Fittings

Sheet Rubber

Index and Technical Information

REDUCER PLATED NPT

Description	Weight (lbs)	Std Pack Qty	Part #
1"NPT X 3/4"REDUCER	0.37	100	RED-100-075
1-1/4"NPT X 1"REDUCER	0.66	80	RED-125-100
1-1/2"NPT X 1-1/4"REDUCER	0.75	60	RED-150-125
2"NPT X 1-1/2"REDUCER	0.88	50	RED-200-150
2-1/2"NPT X 2"REDUCER	1.87	20	RED-250-200
3"NPT X 2-1/2"REDUCER	2.73	50	RED-300-250
4"NPT X 3"REDUCER	5.00	50	RED-400-300



EXPANDER PLATED NPT



Description	Weight (lbs)	Std Pack Qty	Part #
3/4"NPT X 1"EXPANDER	0.22	200	EXP-075-100
1"NPT X 1-1/4"EXPANDER	0.33	80	EXP-100-125
1-1/4"NPT X 1-1/2"EXPANDER	0.48	80	EXP-125-150
1-1/2"NPT X 2"EXPANDER	0.77	60	EXP-150-200
2"NPT X 2-1/2"EXPANDER	1.43	20	EXP-200-250
2-1/2"NPT X 3"EXPANDER	2.38	50	EXP-250-300
3"NPT X 4"EXPANDER	4.03	50	EXP-300-400

SHORT SHANK ALUMINUM FEMALE NPS



Size	Weight (lbs)	Std Pack Qty	Part #
1-1/2"	0.40	75	PF-150-AD
2"	0.66	40	PF-200-AD
2-1/2"	0.97	15	PF-250-AD
3"	1.28	12	PF-300-AD
4"	2.39	10	PF-400-AD
6"	4.68	4	PF-600-AD

Safety Information : Short shank couplings to be used only for low pressure water suction and discharge. They are not suitable for air or gas service

SHORT SHANK ALUMINUM MALE NPS

Size	Weight (lbs)	Std Pack Qty	Part #
1-1/2"	0.21	75	PM-150-A
2"	0.40	40	PM-200-A
2-1/2"	2.11	15	PM-250-A
3"	0.92	12	PM-300-A
4"	1.47	10	PM-400-A
6"	3.03	4	PM-600-A



Safety Information : Short shank couplings to be used only for low pressure water suction and discharge. They are not suitable for air or gas service

SHORT SHANK ALUMINUM SET NPS

Size	Weight (lbs)	Std Pack Qty	Part #
1-1/4"	0.48	75	PL-125-AD
1-1/2"	0.61	75	PL-150-AD
2"	1.06	40	PL-200-AD
2-1/2"	3.08	15	PL-250-AD
3"	2.20	12	PL-300-AD
4"	3.86	10	PL-400-AD
6"	7.71	4	PL-600-AD



Safety Information : Short shank couplings to be used only for low pressure water suction and discharge. They are not suitable for air or gas service

Air and General Purpose Hose

SHORT SHANK BRASS FEMALE GHT

Size	Weight (lbs)	Std Pack Qty	Part #
1/2"	0.11	360	SSF-050-B
5/8"	0.11	360	SSF-063-B
3/4"	0.18	360	SSF-075-B



Safety Information : Short shank couplings to be used only for low pressure water suction and discharge. They are not suitable for air or gas service

Water Suction and Discharge Hose

Petroleum, Steam and Chemical Hose

Rubber Material Handling Hose

SHORT SHANK BRASS MALE GHT

Size	Weight (lbs)	Std Pack Qty	Part #
1/2"	0.11	360	SSM-050-B
5/8"	0.11	360	SSM-063-B
3/4"	0.11	360	SSM-075-B



Safety Information : Short shank couplings to be used only for low pressure water suction and discharge. They are not suitable for air or gas service

Plastic Material Handling Hose

Food Hose

Ducting

Auto Truck and Marine Hose

Fire Hose

Welding and Other Hose

SHORT SHANK BRASS GHT SET

Size	Weight (lbs)	Std Pack Qty	Part #
1/2"	0.22	180	SSH-050-B
5/8"	0.22	180	SSH-063-B
3/4"	0.29	180	SSH-075-B



Safety Information : Short shank couplings to be used only for low pressure water suction and discharge. They are not suitable for air or gas service

Cam and Groove

Nipples, Menders and Shank Fittings

Clamps

High Pressure Fittings

SHORT SHANK BRASS FEMALE NPS

Size	Weight (lbs)	Std Pack Qty	Part #
1-1/2"	0.66	75	PF-150-B
2"	1.10	40	PF-200-B
2-1/2"	1.80	15	PF-250-B
3"	2.50	12	PF-300-B



Safety Information : Short shank couplings to be used only for low pressure water suction and discharge. They are not suitable for air or gas service

Mine Fittings

Air Fittings

Valves

Sandblast

Fire Fittings

Pipe Fittings

Sheet Rubber

Index and Technical Information

SHORT SHANK BRASS MALE NPS

Size	Weight (lbs)	Std Pack Qty	Part #
1-1/2"	0.55	75	PM-150-B
2"	0.88	40	PM-200-B
2-1/2"	1.21	15	PM-250-B
3"	2.09	12	PM-300-B



Safety Information : Short shank couplings to be used only for low pressure water suction and discharge. They are not suitable for air or gas service

SHORT SHANK BRASS SET

Size	Weight (lbs)	Std Pack Qty	Part #
1-1/2"	1.21	75	PL-150-B
2"	1.98	40	PL-200-B
2-1/2"	1.21	15	PL-250-B
3"	2.09	12	PL-300-B



Safety Information : Short shank couplings to be used only for low pressure water suction and discharge. They are not suitable for air or gas service

SHORT SHANK BRASS FEMALE IPT/ NPS

Size	Weight (lbs)	Std Pack Qty	Part #
3/4"	0.18	360	SSFI-075-B



Safety Information : Short shank couplings to be used only for low pressure water suction and discharge. They are not suitable for air or gas service

SHORT SHANK BRASS MALE IPT/ NPS

Size	Weight (lbs)	Std Pack Qty	Part #
1/2"	0.11	360	SSMI-050-B
3/4"	0.11	360	SSMI-075-B



Safety Information : Short shank couplings to be used only for low pressure water suction and discharge. They are not suitable for air or gas service

Air and General Purpose Hose

Water Suction and Discharge Hose

Petroleum, Steam and Chemical Hose

Rubber Material Handling Hose

Plastic Material Handling Hose

Food Hose

Ducting

Auto Truck and Marine Hose

Fire Hose

Welding and Other Hose

Cam and Groove

Nipples, Menders and Shank Fittings

Clamps

High Pressure Fittings

Mine Fittings

Air Fittings

Valves

Sandblast

Fire Fittings

Pipe Fittings

Sheet Rubber

Index and Technical Information

Air and General Purpose Hose

SHORT SHANK BRASS FEMALE IPT/ NPS

Water Suction and Discharge Hose

Size	Weight (lbs)	Std Pack Qty	Part #
1/2"	0.11	360	SSFI-050-B
1"	0.18	240	SSF-100-B



Petroleum, Steam and Chemical Hose

Safety Information : Short shank couplings to be used only for low pressure water suction and discharge. They are not suitable for air or gas service

Rubber Material Handling Hose

SHORT SHANK BRASS IPT/ NPS SET

Plastic Material Handling Hose

Size	Weight (lbs)	Std Pack Qty	Part #
1/2"	0.22	180	SSHI-050-B
3/4"	0.29	180	SSHI-075-B



Food Hose

Safety Information : Short shank couplings to be used only for low pressure water suction and discharge. They are not suitable for air or gas service

Ducting

Auto Truck and Marine Hose

Fire Hose

Welding and Other Hose

SHORT SHANK BRASS MALE NPS

Cam and Groove

Nipples, Menders and Shank Fittings

Size	Weight (lbs)	Std Pack Qty	Part #
1"	0.11	240	SSM-100-B



Clamps

Safety Information : Short shank couplings to be used only for low pressure water suction and discharge. They are not suitable for air or gas service

High Pressure Fittings

Mine Fittings

SHORT SHANK BRASS NPS SET

Air Fittings

Size	Weight (lbs)	Std Pack Qty	Part #
1"	0.29	120	SSH-100-B



Valves

Sandblast

Fire Fittings

Pipe Fittings

Sheet Rubber

Safety Information : Short shank couplings to be used only for low pressure water suction and discharge. They are not suitable for air or gas service

Index and Technical Information

SHORT SHANK MALLEABLE FEMALE NPS



Size	Weight (lbs)	Std Pack Qty	Part #
1-1/2"	0.63	75	PF-150-DP
2"	0.99	40	PF-200-DP
2-1/2"	1.74	15	PF-250-DP
3"	2.11	12	PF-300-DP
4"	4.41	10	PF-400-DP
6"	8.81	4	PF-600-DP

Safety Information : Short shank couplings to be used only for low pressure water suction and discharge. They are not suitable for air or gas service

SHORT SHANK MALLEABLE MALE NPS

Size	Weight (lbs)	Std Pack Qty	Part #
1-1/2"	0.55	75	PM-150-DP
2"	0.92	40	PM-200-DP
2-1/2"	1.56	15	PM-250-DP
3"	2.81	12	PM-300-DP
4"	4.41	10	PM-400-DP
6"	7.98	4	PM-600-DP



Safety Information : Short shank couplings to be used only for low pressure water suction and discharge. They are not suitable for air or gas service

SHORT SHANK MALLEABLE SET NPS



Size	Weight (lbs)	Std Pack Qty	Part #
1-1/2"	1.18	75	PL-150-DP
2"	1.91	40	PL-200-DP
2-1/2"	3.30	15	PL-250-DP
3"	4.92	12	PL-300-DP
4"	8.82	10	PL-400-DP
6"	16.79	4	PL-600-DP

Safety Information : Short shank couplings to be used only for low pressure water suction and discharge. They are not suitable for air or gas service

Air and General Purpose Hose

Water Suction and Discharge Hose

Petroleum, Steam and Chemical Hose

Rubber Material Handling Hose

Plastic Material Handling Hose

Food Hose

Ducting

Auto Truck and Marine Hose

Fire Hose

Welding and Other Hose

Cam and Groove

Nipples, Menders and Shank Fittings

Clamps

High Pressure Fittings

Mine Fittings

Air Fittings

Valves

Sandblast

Fire Fittings

Pipe Fittings

Sheet Rubber

Index and Technical Information

Air and
General
Purpose
Hose

SHORT SHANK GASKET

Description	Weight (lbs)	Std Pack Qty	Part #
1-1/2" SHORT SHANK GASKET	0.01	100	PG-150-NBR
2" SHORT SHANK GASKET	0.01	100	PG-200-NBR
2-1/2" SHORT SHANK GASKET	0.01	100	PG-250-NBR
3" SHORT SHANK GASKET	0.03	100	PG-300-NBR
4" SHORT SHANK GASKET	0.03	100	PG-400-NBR
6" SHORT SHANK GASKET	0.12	100	PG-600-NBR

Water
Suction
and
Discharge
Hose

Petroleum,
Steam and
Chemical
Hose

Rubber
Material
Handling
Hose

Plastic
Material
Handling
Hose

Food Hose

Ducting

Auto
Truck and
Marine
Hose

Fire Hose

Welding
and
Other Hose

Cam
and
Groove

Nipples
Menders
and
Shank
Fittings

Clamps

High
Pressure
Fittings

Mine
Fittings

Air
Fittings

Valves

Sandblast

Fire
Fittings

Pipe
Fittings

Sheet
Rubber

Index
and
Technical
Information

LONG SHANK



- Air and General Purpose Hose
- Water Suction and Discharge Hose
- Petroleum, Steam and Chemical Hose
- Rubber Material Handling Hose
- Plastic Material Handling Hose
- Food Hose
- Ducting
- Auto Truck and Marine Hose
- Fire Hose
- Welding and Other Hose
- Cam and Groove
- Nipples, Menders and Shank Fittings
- Clamps
- High Pressure Fittings
- Mine Fittings
- Air Fittings
- Valves
- Sandblast
- Fire Fittings
- Pipe Fittings
- Sheet Rubber
- Index and Technical Information

LONG SHANK BRASS FEM GHT

Size	Weight (lbs)	Std Pack Qty	Part #
1/2"	0.15	25	LFGHT-050-B
3/4"	0.24	25	LFGHT-075-B

LONG SHANK BRASS FEMALE IPT/NPS

Description	Weight (lbs)	Std Pack Qty	Part #
1/2"X1/2"LONG SHANK BRASS FEM IPT	0.15	25	LF-050A-B
1/2"X3/4"LONG SHANK BRASS FEM IPT	0.15	25	LF-050B-B
3/4"LONG SHANK BRASS FEM IPT	0.24	25	LF-075-B
1"LONG SHANK BRASS FEM IPT	0.44	25	LF-100-B
1-1/4" LONG SHANK BRASS FEM	0.88	25	LF-125-B
1-1/2" LONG SHANK BRASS FEM	1.10	25	LF-150-B
2" LONG SHANK BRASS FEM	1.65	25	LF-200-B

LONG SHANK BRASS MALE GHT

Size	Weight (lbs)	Std Pack Qty	Part #
1/2"	0.22	25	LMGHT-050-B
3/4"	0.22	25	LMGHT-075-B

Air and General Purpose Hose

LONG SHANK BRASS MALE IPT/NPS

Description	Weight (lbs)	Std Pack Qty	Part #
1/2"LONG SHANK BRASS MALE IPT	0.13	25	LM-050-B
1/2"X1/2"LONG SHANK BRASS MALE IPT	0.13	25	LM-050A-B
1/2"X3/4"LONG SHANK BRASS MALE IPT	0.22	25	LM-050B-B
3/4"LONG SHANK BRASS MALE IPT	0.22	25	LM-075-B
1" LONG SHANK BRASS MALE IPT	0.37	25	LM-100-B
1-1/4" LONG SHANK BRASS MALE	0.88	50	LM-125-B
1-1/2" LONG SHANK BRASS MALE	1.03	25	LM-150-B
2" LONG SHANK BRASS MALE	3.30	25	LM-200-B

Water Suction and Discharge Hose

Petroleum, Steam and Chemical Hose

Rubber Material Handling Hose

Plastic Material Handling Hose

LONG SHANK BRASS SET GHT

Size	Weight (lbs)	Std Pack Qty	Part #
1/2"	0.37	1	GSHT-075-B
1/2"	0.37	25	LSGHT-050-B
3/4"	0.37	25	LSGHT-075-B

Food Hose

Ducting

Auto Truck and Marine Hose

Fire Hose

LONG SHANK BRASS SET IPT/NPS

Description	Weight (lbs)	Std Pack Qty	Part #
1/2"LONG SHANK BRASS SET IPT	0.28	25	LS-050-B
1/2"X1/2"LONG SHANK BRASS SET IPT	0.28	25	LS-050A-B
1/2"X3/4"LONG SHANK BRASS SET IPT	0.37	25	LS-050B-B
3/4"LONG SHANK BRASS SET IPT	0.46	25	LS-075-B
1"LONG SHANK BRASS SET IPT	0.81	25	LS-100-B
1-1/4" LONG SHANK BRASS SET	1.76	25	LS-125-B
1-1/2" LONG SHANK BRASS SET	2.13	25	LS-150-B
2" LONG SHANK BRASS SET	4.95	25	LS-200-B

Welding and Other Hose

Cam and Groove

Nipples, Menders and Shank Fittings

Clamps

High Pressure Fittings

Mine Fittings

LONG SHANK GASKET

Size	Description	Weight (lbs)	Std Pack Qty	Part #
1-1/4"	1-1/4" LONG SHANK GASKET	0.04	25	LW-125-R
1-1/2"	1-1/2" LONG SHANK GASKET	0.01	25	LW-150-R
2"	2" LONG SHANK GASKET	0.01	50	LW-200-R

Air Fittings

Valves

Sandblast

Fire Fittings

Pipe Fittings

Sheet Rubber

Index and Technical Information

LONG+SHORT SHANK GASKET

Size	Description	Weight (lbs)	Std Pack Qty	Part #
1/2"	1/2"LONG+SHORT SHANK GASKET	0.04	25	LW-050-R
3/4"	3/4"LONG+SHORT SHANK GASKET	0.04	25	LW-075-R
1"	1"LONG+SHORT SHANK GASKET	0.04	25	LW-100-R

Air and General Purpose Hose

Water Suction and Discharge Hose

Petroleum, Steam and Chemical Hose

Rubber Material Handling Hose

Plastic Material Handling Hose

Food Hose

Ducting

Auto Truck and Marine Hose

Fire Hose

Welding and Other Hose

Cam and Groove

Nipples, Menders and Shank Fittings

Clamps

High Pressure Fittings

Mine Fittings

Air Fittings

Valves

Sandblast

Fire Fittings

Pipe Fittings

Sheet Rubber

Index and Technical Information

Air and General Purpose Hose

Water Suction and Discharge Hose

Petroleum, Steam and Chemical Hose

Rubber Material Handling Hose

Plastic Material Handling Hose

Food Hose

Ducting

Auto Truck and Marine Hose

Fire Hose

Welding and Other Hose

Cam and Groove

Nipples, Menders and Shank Fittings

Clamps

High Pressure Fittings

Mine Fittings

Air Fittings

Valves

Sandblast

Fire Fittings

Pipe Fittings

Sheet Rubber

Index and Technical Information

IRRIGATION COUPLING FEMALE SHANK WITH GASKET



Size	Weight (lbs)	Std Pack Qty	Part #
2"	0.84	16	BE-200-SP1
3"	1.32	16	BE-300-SP1
4"	3.56	4	BE-400-SP1
6"	5.90	4	BE-600-SP1
8"	11.55	1	BE-800-SP1

IRRIGATION COUPLING MALE SHANK

Size	Weight (lbs)	Std Pack Qty	Part #
2"	0.86	16	BCS-200-SP1
3"	1.32	16	BCS-300-SP1
4"	3.74	4	BCS-400-SP1
6"	5.57	4	BCS-600-SP1
8"	10.45	1	BCS-800-SP1



IRRIGATION COUPLING LOCKING LEVER



Size	Weight (lbs)	Std Pack Qty	Part #
2"	1.03	16	BL-200-SP
3"	2.42	12	BL-300-SP
4"	4.07	6	BL-400-SP
6"	8.51	4	BL-600-SP
8"	9.15	1	BL-800-SP

IRRIGATION COUPLING MALE SHANK WITH LOCKING LEVER

Size	Weight (lbs)	Std Pack Qty	Part #
2"	1.89	9	BC-200-SP1
3"	3.74	9	BC-300-SP1
4"	7.81	4	BC-400-SP1
6"	14.08	2	BC-600-SP1
8"	19.60	1	BC-800-SP1



Air and General Purpose Hose

IRRIGATION COUPLING SET

Water Suction and Discharge Hose



Size	Weight (lbs)	Std Pack Qty	Part #
2"	2.73	8	BCE-200-SP1
3"	5.06	6	BCE-300-SP1
4"	15.11	1	BCE-400-SP1
6"	19.98	1	BCE-600-SP1
8"	31.15	1	BCE-800-SP1

Petroleum, Steam and Chemical Hose

Rubber Material Handling Hose

IRRIGATION COUPLING FEMALE WITH GASKET X MALE NPT

Plastic Material Handling Hose

Size	Weight (lbs)	Std Pack Qty	Part #
2"	0.90	16	BF-200-SP
3"	1.61	16	BF-300-SP
4"	3.39	4	BF-400-SP
6"	5.90	4	BF-600-SP
8"	11.55	1	BF-800-SP



Food Hose

Ducting

Auto Truck and Marine Hose

Fire Hose

IRRIGATION COUPLING MALE X MALE NPT

Welding and Other Hose

Cam and Groove

Nipples, Menders and Shank Fittings

Clamps



Size	Weight (lbs)	Std Pack Qty	Part #
2"	0.92	16	BBT-200-SP
3"	1.5	16	BBT-300-SP
4"	3.52	4	BBT-400-SP
6"	5.43	4	BBT-600-SP
8"	10.45	1	BBT-800-SP

High Pressure Fittings

IRRIGATION COUPLING MALE LOCKING X MALE NPT

Mine Fittings

Air Fittings

Valves

Sandblast

Fire Fittings

Pipe Fittings

Sheet Rubber

Index and Technical Information

Size	Weight (lbs)	Std Pack Qty	Part #
2"	1.96	9	BB-200-SP
3"	3.92	6	BB-300-SP
4"	7.50	4	BB-400-SP
6"	13.95	2	BB-600-SP
8"	19.60	1	BB-800-SP



IRRIGATION COUPLING SAFETY CLIP



Size	Weight (lbs)	Std Pack Qty	Part #
2"		100	BSC-200-SP
3"		100	BSC-300-SP
4"		60	BSC-400-SP
6"		60	BSC-600-SP
8"		20	BSC-800-SP

IRRIGATION COUPLING GASKET

Size	Weight (lbs)	Std Pack Qty	Part #
2"	0.04	40	IRG-200-EPDM
3"	0.13	40	IRG-300-EPDM
4"	0.22	30	IRG-400-EPDM
6"	0.53	10	IRG-600-EPDM
8"	0.66	10	IRG-800-EPDM

Air and General Purpose Hose

Water Suction and Discharge Hose

Petroleum, Steam and Chemical Hose

Rubber Material Handling Hose

Plastic Material Handling Hose

Food Hose

Ducting

Auto Truck and Marine Hose

Fire Hose

Welding and Other Hose

Cam and Groove

Nipples, Menders and Shank Fittings

Clamps

High Pressure Fittings

Mine Fittings

Air Fittings

Valves

Sandblast

Fire Fittings

Pipe Fittings

Sheet Rubber

Index and Technical Information

DOUBLE BOLT CLAMP



Application	: A rugged ductile iron two bolt clamp with saddles				Part #
Size	Open	Bolt Torque FT LBS	Weight (lbs)		
21/32"	7/8"	15	0.22	DBC-22-DP	
7/8"	1-9/64"	15	0.33	DBC-29-DP	
1-5/16"	1-11/16"	15	0.35	DBC-34-DP	
1-5/16"	1-19/32"	20	0.48	DBC-40-DP	
1-5/8"	1-15/16"	25	0.40	DBC-49-DP	
1-7/8"	2-3/8"	25	0.70	DBC-60-DP	
2-3/8"	3-1/16"	25	0.79	DBC-76-DP	
3-1/2"	3-11/16"	40	1.32	DBC-94-DP	
3-3/4"	4-1/2"	40	2.20	DBC-115-DP	
3-1/2"	4"	40	1.76	DBC-400-DP	
3-13/16"	4-1/16"	40	2.20	DBC-431-DP	
4-1/16"	4-7/16"	40	1.76	DBC-463-DP	
4-3/16"	5"	60	2.31	DBC-525-DP	
5"	5-1/2"	60	2.31	DBC-550-DP	
5-1/2"	5-15/16"	60	2.64	DBC-600-DP	
5-11/16"	5-15/16"	60	2.60	DBC-639-DP	
6-1/8"	6-7/8"	60	2.64	DBC-675-DP	
6-15/16"	7-5/8"	60	3.30	DBC-769-DP	
7-11/16"	8-3/16"	125	5.29	DBC-818-DP	
8-1/4"	8-7/8"	125	5.29	DBC-875-DP	
8-15/16"	9-7/8"	125	5.95	DBC-988-DP	
9-15/16"	11-3/8"	125	9.36	DBC-1125-DP	
11-3/16"	13"	125	9.36	DBC-1275-DP	
12-3/16"	14"	200	14.50	DBC-1360-DP	
13-3/16"	15"	200	16.15	DBC-1450-DP	
15-1/16"	17-1/2"	260	21.29	DBC-1700-DP	

Air and
General
Purpose
Hose

HEAVY DUTY CLAMP

Water
Suction
and
Discharge
Hose



Petroleum,
Steam and
Chemical
Hose

Rubber
Material
Handling
Hose

	Size	Open	Bolt Torque FT LBS	Weight (lbs)	Std Pack Qty	Part #
Plastic Material Handling Hose	1-1/8"	1-1/4"	15	0.40	120	R88DB-12-DP
	1-3/8"	1-1/2"	20	0.40	100	R88DB-16-DP
Food Hose	1-5/8"	1-3/4"	25	0.55	100	R88DB-20-DP
Ducting	2"	2-1/8"	25	0.63	80	R88DB-24-DP
Auto Truck and Marine Hose	2-1/4"	2-3/8"	30	1.03	60	R88DB-32-DP

Fire Hose

Welding
and
Other Hose

Cam
and
Groove

Nipples
Menders
and
Shank
Fittings

Clamps

High
Pressure
Fittings

Mine
Fittings

Air
Fittings

Valves

Sandblast

Fire
Fittings

Pipe
Fittings

Sheet
Rubber

Index
and
Technical
Information

GEAR CLAMPS

Size	Fractional Min	Fractional Max	Weight (lbs)	Std Pack Qty	Part #
7/16"	3/8"	7/8"	0.04	10	GC-06
1/2"	7/16"	1"	0.04	10	GC-08
5/8"	9/16"	1-1/16"	0.04	10	GC-10
3/4"	9/16"	1-1/4"	0.04	10	GC-12
1"	11/16"	1-1/2"	0.05	10	GC-16
1-1/4"	3/4"	1-3/4"	0.05	10	GC-20
1-1/2"	1-1/16"	2"	0.05	10	GC-24
1-3/4"	1-5/16"	2-1/4"	0.05	10	GC-28
2"	1-9/16"	2-1/2"	0.06	10	GC-32
2-1/4"	1-13/16"	2-3/4"	0.06	10	GC-36
2-1/2"	2-1/16"	3"	0.06	10	GC-40
2-3/4"	2-5/16"	3-1/4"	0.07	10	GC-44
3"	2-9/16"	3-1/2"	0.07	10	GC-48
3-1/4"	2-13/16"	3-3/4"	0.07	10	GC-52
3-1/2"	3-1/16"	4"	0.07	10	GC-56
3-3/4"	3-5/16"	4-1/4"	0.08	10	GC-60
3-1/2"	2-1/2"	4-1/2"	0.08	10	GC-64
4"	3"	5"	0.08	10	GC-72
4-1/2"	3-1/2"	5-3/4"	0.09	10	GC-80
4-3/4"	3-3/4"	5-3/4"	0.09	10	GC-84
5-1/2"	4"	6"	0.09	10	GC-88
6"	4-1/2"	6-1/2"	0.10	10	GC-96
6-1/2"	5"	7"	0.11	100	GC-104
7"	5-3/4"	7-3/4"	0.11	100	GC-116
8"	6-1/2"	8-1/2"	0.12	100	GC-128
9-1/2"	8"	10"	0.14	100	GC-152
10"	8-3/4"	10-3/4"	0.14	100	GC-164
11-3/4"	10-1/4"	12-1/4"	0.16	100	GC-188
12-1/2"	11"	13"	0.17	100	GC-200
13-1/4"	11-3/4"	13-3/4"	0.18	100	GC-212
14"	12-1/2"	14-1/2"	0.18	100	GC-224
14-3/4"	13-1/4"	15-1/4"	0.19	100	GC-236
15-1/2"	14"	16"	0.20	100	GC-248
16-5/8"	15-3/8"	17-3/8"	0.22	100	GC-270
19-1/2"	18"	20"	0.24	100	GC-312
24-1/8"	22-7/8"	24-7/8"	0.30	100	GC-390

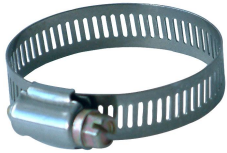

GEAR CLAMP MICRO



	Size	Fractional Min	Fractional Max	Weight (lbs)	Std Pack Qty	Part #
Air and General Purpose Hose	7/16"	7/32"	5/8"	0.02	10	GCM-04
Water Suction and Discharge Hose	1/2"	7/16"	11/16"	0.02	10	GCM-05
Petroleum, Steam and Chemical Hose	9/16"	5/16"	7/8"	0.02	10	GCM-06
Rubber Material Handling Hose	5/8"	7/16"	1"	0.02	10	GCM-08
	3/4"	1/2"	1-1/16"	0.02	10	GCM-10
	13/16"	9/16"	1-1/4"	0.02	10	GCM-12
	1"	11/16"	1-1/2"	0.02	10	GCM-16
Plastic Material Handling Hose	1-1/4"	7/8"	1-3/4"	0.03	10	GCM-20
	1-1/2"	1-5/16"	2"	0.03	10	GCM-24
Food Hose	1-3/4"	1-9/16"	2-1/4"	0.03	10	GCM-28
Ducting	2"	1-13/16"	2-1/2"	0.03	10	GCM-32
	2-1/4"	2-1/16"	2-3/4"	0.03	10	GCM-36

Air and General Purpose Hose

Water Suction and Discharge Hose

Petroleum, Steam and Chemical Hose

Rubber Material Handling Hose

Plastic Material Handling Hose

Food Hose

Ducting

Auto Truck and Marine Hose

Fire Hose

Welding and Other Hose

Cam and Groove

Nipples Menders and Shank Fittings

Clamps

High Pressure Fittings

Mine Fittings

Air Fittings

Valves

Sandblast

Fire Fittings

Pipe Fittings

Sheet Rubber

Index and Technical Information

TRIDON GEAR CLAMP MICRO

Size	Fractional Min	Fractional Max	Weight (lbs)	Std Pack Qty	Part #
1/2"	7/16"	11/16"	0.02	10	MH-05
7/16"	7/32"	5/8"	0.02	10	MH-04
9/16"	5/16"	7/8"	0.02	10	MH-06
5/8"	7/16"	1"	0.02	10	MH-08
3/4"	1/2"	1-1/16"	0.02	10	MH-10
13/16"	9/16"	1-1/4"	0.02	10	MH-12
1"	11/16"	1-1/2"	0.02	10	MH-16
1-1/4"	7/8"	1-3/4"	0.03	10	MH-20
1-1/2"	1-5/16"	2"	0.03	10	MH-24
1-3/4"	1-9/16"	2-1/4"	0.03	10	MH-28
2"	1-13/16"	2-1/2"	0.03	10	MH-32
2-1/4"	2-1/16"	2-3/4"	0.03	10	MH-36



Product Information : 5/16" wide 201 Stainless band and housing with 1/4" plated carbon steel screw.

Air and General Purpose Hose

Water Suction and Discharge Hose

Petroleum, Steam and Chemical Hose

Rubber Material Handling Hose

Plastic Material Handling Hose

Food Hose

Ducting

Auto Truck and Marine Hose

Fire Hose

Welding and Other Hose

Cam and Groove

Nipples, Menders and Shank Fittings

Clamps

High Pressure Fittings

Mine Fittings

Air Fittings

Valves

Sandblast

Fire Fittings

Pipe Fittings

Sheet Rubber

Index and Technical Information

TRIDON GEAR CLAMP

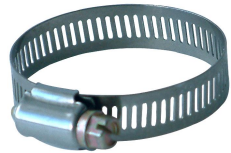

	Size	Fractional Min	Fractional Max	Weight (lbs)	Std Pack Qty	Part #
Air and General Purpose Hose	7/16"	3/8"	7/8"	0.04	10	HS-06
Water Suction and Discharge Hose	1/2"	7/16"	1"	0.04	10	HS-08
Petroleum, Steam and Chemical Hose	5/8"	9/16"	1-1/16"	0.04	10	HS-10
Rubber Material Handling Hose	3/4"	9/16"	1-1/4"	0.04	10	HS-12
	1"	11/16"	1-1/2"	0.05	10	HS-16
Plastic Material Handling Hose	1-1/4"	3/4"	1-3/4"	0.05	10	HS-20
	1-1/2"	1-1/16"	2"	0.05	10	HS-24
	1-3/4"	1-5/16"	2-1/4"	0.05	10	HS-28
Food Hose	2"	1-9/16"	2-1/2"	0.06	10	HS-32
Ducting	2-1/4"	1-13/16"	2-3/4"	0.06	10	HS-36
	2-1/2"	2-1/16"	3"	0.06	10	HS-40
Auto Truck and Marine Hose	2-3/4"	2-5/16"	3-1/4"	0.07	10	HS-44
	3"	2-9/16"	3-1/2"	0.07	10	HS-48
Fire Hose	3-1/4"	2-13/16"	3-3/4"	0.07	10	HS-52
Welding and Other Hose	3-1/2"	3-1/16"	4"	0.07	10	HS-56
	3-3/4"	3-5/16"	4-1/4"	0.08	10	HS-60
Cam and Groove	3-1/2"	2-1/2"	4-1/2"	0.08	10	HS-64
Nipples Menders and Shank Fittings	4"	3"	5"	0.08	10	HS-72
	4-1/2"	3-1/2"	5-3/4"	0.09	10	HS-80
	4-3/4"	3-3/4"	5-3/4"	0.09	10	HS-84
	5-1/2"	4"	6"	0.09	10	HS-88
	6"	4-1/2"	6-1/2"	0.10	10	HS-96
Clamps	6-1/2"	5"	7"	0.11	100	HS-104
	7"	5-3/4"	7-3/4"	0.11	100	HS-116
High Pressure Fittings	8"	6-1/2"	8-1/2"	0.12	100	HS-128
	9-1/2"	8"	10"	0.14	100	HS-152
Mine Fittings	10"	8-3/4"	10-3/4"	0.14	100	HS-164
Air Fittings	11-3/4"	10-1/4"	12-1/4"	0.16	100	HS-188
	12-1/2"	11"	13"	0.17	100	HS-200
Valves	13-1/4"	11-3/4"	13-3/4"	0.18	100	HS-212
Sandblast	14"	12-1/2"	14-1/2"	0.18	100	HS-224
Fire Fittings	14-3/4"	13-1/4"	15-1/4"	0.19	100	HS-236
Pipe Fittings	15-1/2"	14"	16"	0.20	100	HS-248
	16-5/8"	15-3/8"	17-3/8"	0.22	100	HS-270
Sheet Rubber	19-1/2"	18"	20"	0.24	100	HS-312
Index and Technical Information	24-1/8"	22-7/8"	24-7/8"	0.30	100	HS-390

Product Information : 1/2" Wide 201 Stainless Steel band and 301 Stainless Steel housing

TRIDON GEAR CLAMP SILICONE

Size	Fractional Min	Fractional Max	Weight (lbs)	Std Pack Qty	Part #
1/2"	5/8"	13/16"	0.04	10	ET-08
7/8"	3/4"	15/16"	0.04	10	ET-10
7/8"	3/4"	1-1/8"	0.04	10	ET-12
1"	13/16"	1-3/8"	0.07	10	ET-16
1-1/4"	1-1/8"	1-5/8"	0.07	10	ET-20
1-1/2"	1-3/16"	1-15/16"	0.07	10	ET-24
1-3/4"	1-5/16"	2-1/4"	0.07	10	ET-28
2"	1-9/16"	2-1/2"	0.07	10	ET-32
2-1/4"	1-13/16"	2-3/4"	0.07	10	ET-36
2-1/2"	2-1/16"	3"	0.09	10	ET-40
2-3/4"	2-5/16"	3-1/4"	0.09	10	ET-44
3"	2-9/16"	3-1/2"	0.09	10	ET-48



Product Information : 1/2" wide 301 Stainless steel band and housing with carbon steel screw. Also incorporates a 301 Stainless steel inner shield to protect silicone hose

- Air and General Purpose Hose
- Water Suction and Discharge Hose
- Petroleum, Steam and Chemical Hose
- Rubber Material Handling Hose
- Plastic Material Handling Hose
- Food Hose
- Ducting
- Auto Truck and Marine Hose
- Fire Hose
- Welding and Other Hose
- Cam and Groove
- Nipples Menders and Shank Fittings
- Clamps
- High Pressure Fittings
- Mine Fittings
- Air Fittings
- Valves
- Sandblast
- Fire Fittings
- Pipe Fittings
- Sheet Rubber
- Index and Technical Information

Air and General Purpose Hose

Water Suction and Discharge Hose

Petroleum, Steam and Chemical Hose

Rubber Material Handling Hose

Plastic Material Handling Hose

Food Hose

Ducting

Auto Truck and Marine Hose

Fire Hose

Welding and Other Hose

Cam and Groove

Nipples Menders and Shank Fittings

Clamps

High Pressure Fittings

Mine Fittings

Air Fittings

Valves

Sandblast

Fire Fittings

Pipe Fittings

Sheet Rubber

Index and Technical Information

GEAR CLAMP STAINLESS

Size	Fractional Min	Fractional Max	Weight (lbs)	Std Pack Qty	Part #
7/16"	3/8"	7/8"	0.04	10	GCS-06
1/2"	7/16"	1"	0.04	10	GCS-08
5/8"	9/16"	1-1/16"	0.04	10	GCS-10
3/4"	9/16"	1-1/4"	0.04	10	GCS-12
1"	11/16"	1-1/2"	0.05	10	GCS-16
1-1/4"	3/4"	1-3/4"	0.05	10	GCS-20
1-1/2"	1-1/16"	2"	0.05	10	GCS-24
1-3/4"	1-5/16"	2-1/4"	0.05	10	GCS-28
2"	1-9/16"	2-1/2"	0.06	10	GCS-32
2-1/4"	1-13/16"	2-3/4"	0.06	10	GCS-36
2-1/2"	2-1/16"	3"	0.06	10	GCS-40
2-3/4"	2-5/16"	3-1/4"	0.06	10	GCS-44
3"	2-9/16"	3-1/2"	0.07	10	GCS-48
3-1/4"	2-13/16"	3-3/4"	0.07	10	GCS-52
3-1/2"	3-1/16"	4"	0.07	10	GCS-56
3-3/4"	3-5/16"	4-1/4"	0.08	10	GCS-60
3-1/2"	2-1/2"	4-1/2"	0.08	10	GCS-64
4"	3"	5"	0.08	10	GCS-72
4-1/2"	3-1/2"	5-3/4"	0.09	10	GCS-80
4-3/4"	3-3/4"	5-3/4"	0.09	10	GCS-84
5-1/2"	4"	6"	0.09	10	GCS-88
6"	4-1/2"	6-1/2"	0.10	10	GCS-96
6-1/2"	5"	7"	0.10	100	GCS-104
7"	5-3/4"	7-3/4"	0.11	100	GCS-116
8"	6-1/2"	8-1/2"	0.12	100	GCS-128
9-1/2"	8"	10"	0.14	100	GCS-152
10"	8-3/4"	10-3/4"	0.14	100	GCS-164
11-3/4"	10-1/4"	12-1/4"	0.16	100	GCS-188
12-1/2"	11"	13"	0.17	100	GCS-200
13-1/4"	11-3/4"	13-3/4"	0.18	100	GCS-212
14"	12-1/2"	14-1/2"	0.18	100	GCS-224
14-3/4"	13-1/4"	15-1/4"	0.19	100	GCS-236
15-1/2"	14"	16"	0.20	100	GCS-248
16-5/8"	15-3/8"	17-3/8"	0.21	100	GCS-270
19-1/2"	18"	20"	0.24	100	GCS-312
24-1/8"	22-7/8"	24-7/8"	0.29	100	GCS-390

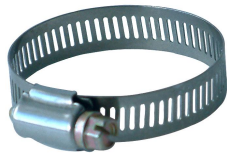

Air and General Purpose Hose

GEAR CLAMP MICRO STAINLESS

	Size	Fractional Min	Fractional Max	Weight (lbs)	Std Pack Qty	Part #
Water Suction and Discharge Hose	7/16"	7/32"	5/8"	0.02	10	GCMS-04
	1/2"	7/16"	11/16"	0.02	10	GCMS-05
Petroleum, Steam and Chemical Hose	9/16"	5/16"	7/8"	0.02	10	GCMS-06
	5/8"	7/16"	1"	0.02	10	GCMS-08
Rubber Material Handling Hose	3/4"	1/2"	1-1/16"	0.02	10	GCMS-10
	13/16"	9/16"	1-1/4"	0.02	10	GCMS-12
	1"	11/16"	1-1/2"	0.02	10	GCMS-16
Plastic Material Handling Hose	1-1/4"	7/8"	1-3/4"	0.02	10	GCMS-20
	1-1/2"	1-5/16"	2"	0.03	10	GCMS-24
Food Hose	1-3/4"	1-9/16"	2-1/4"	0.03	10	GCMS-28
	2"	1-13/16"	2-1/2"	0.03	10	GCMS-32
Ducting	2-1/4"	2-1/16"	2-3/4"	0.03	10	GCMS-36



GEAR CLAMP STAINLESS QUICK RELEASE

	Size	Fractional I Min	Fractional I Max	Weight (lbs)	Std Pack Qty	Part #
Fire Hose	3"	1-1/2"	3-1/2"	0.08	10	GCL-48
Welding and Other Hose	3-1/2"	1"	4"	0.09	10	GCL-56
Cam and Groove	4-1/2"	2"	5"	0.10	10	GCL-72
Nipples, Menders and Shank Fittings	5-1/2"	2-1/16"	6"	0.11	10	GCL-88
	6"	3-1/2"	6-9/16"	0.11	10	GCL-96
Clamps	6-1/2"	1-3/4"	7"	0.12	100	GCL-104
	8"	1-3/4"	8-9/16"	0.13	100	GCL-128
High Pressure Fittings	9-1/2"	2"	10"	0.15	100	GCL-152
	11-3/4"	2-1/16"	12-5/16"	0.17	100	GCL-188



TRIDON GEAR CLAMP STAINLESS

Size	Fractional Min	Fractional Max	Weight (lbs)	Std Pack Qty	Part #
7/16"	3/8"	7/8"	0.04	10	HAS-06
1/2"	7/16"	1"	0.04	10	HAS-08
5/8"	9/16"	1-1/16"	0.04	10	HAS-10
3/4"	9/16"	1-1/4"	0.04	10	HAS-12
1"	11/16"	1-1/2"	0.05	10	HAS-16
1-1/4"	3/4"	1-3/4"	0.05	10	HAS-20
1-1/2"	1-1/16"	2"	0.05	10	HAS-24
1-3/4"	1-5/16"	2-1/4"	0.05	10	HAS-28
2"	1-9/16"	2-1/2"	0.06	10	HAS-32
2-1/4"	1-13/16"	2-3/4"	0.06	10	HAS-36
2-1/2"	2-1/16"	3"	0.06	10	HAS-40
2-3/4"	2-5/16"	3-1/4"	0.06	10	HAS-44
3"	2-9/16"	3-1/2"	0.07	10	HAS-48
3-1/4"	2-13/16"	3-3/4"	0.07	10	HAS-52
3-1/2"	3-1/16"	4"	0.07	10	HAS-56
3-3/4"	3-5/16"	4-1/4"	0.08	10	HAS-60
3-1/2"	2-1/2"	4-1/2"	0.08	10	HAS-64
4"	3"	5"	0.08	10	HAS-72
4-1/2"	3-1/2"	5-3/4"	0.09	10	HAS-80
4-3/4"	3-3/4"	5-3/4"	0.09	10	HAS-84
5-1/2"	4"	6"	0.09	10	HAS-88
6"	4-1/2"	6-1/2"	0.10	10	HAS-96
6-1/2"	5"	7"	0.10	100	HAS-104
7"	5-3/4"	7-3/4"	0.11	100	HAS-116
8"	6-1/2"	8-1/2"	0.12	100	HAS-128
9-1/2"	8"	10"	0.14	100	HAS-152
10"	8-3/4"	10-3/4"	0.14	100	HAS-164
11-3/4"	10-1/4"	12-1/4"	0.16	100	HAS-188
12-1/2"	11"	13"	0.17	100	HAS-200
13-1/4"	11-3/4"	13-3/4"	0.18	100	HAS-212
14"	12-1/2"	14-1/2"	0.18	100	HAS-224
14-3/4"	13-1/4"	15-1/4"	0.19	100	HAS-236
15-1/2"	14"	16"	0.20	100	HAS-248
16-5/8"	15-3/8"	17-3/8"	0.21	100	HAS-270
19-1/2"	18"	20"	0.24	100	HAS-312
24-1/8"	22-7/8"	24-7/8"	0.29	100	HAS-390

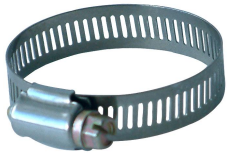

Product Information : 5/16" Wide 301 Stainless Steel band and housing with 5/16" 401 Stainless Steel screw. Designed to allow rapid installation and removal.

Air and General Purpose Hose

Water Suction and Discharge Hose

Petroleum, Steam and Chemical Hose

Rubber Material Handling Hose

Plastic Material Handling Hose

Food Hose

Ducting

Auto Truck and Marine Hose

Fire Hose

Welding and Other Hose

Cam and Groove

Nipples Menders and Shank Fittings

Clamps

High Pressure Fittings

Mine Fittings

Air Fittings

Valves

Sandblast

Fire Fittings

Pipe Fittings

Sheet Rubber

Index and Technical Information

Air and General Purpose Hose

TRIDON GEAR CLAMP MICRO STAINLESS

Water Suction and Discharge Hose

Size	Fractional Min	Fractional Max	Weight (lbs)	Std Pack Qty	Part #
7/16"	7/32"	5/8"	0.02	10	MAH-04
9/16"	5/16"	7/8"	0.02	10	MAH-06
5/8"	7/16"	1"	0.02	10	MAH-08
3/4"	1/2"	1-1/16"	0.02	10	MAH-10
13/16"	9/16"	1-1/4"	0.02	10	MAH-12
1"	11/16"	1-1/2"	0.02	10	MAH-16
1-1/4"	7/8"	1-3/4"	0.02	10	MAH-20
1-1/2"	1-5/16"	2"	0.03	10	MAH-24
1-3/4"	1-9/16"	2-1/4"	0.03	10	MAH-28
2"	1-13/16"	2-1/2"	0.03	10	MAH-32
2-1/4"	2-1/16"	2-3/4"	0.03	10	MAH-36



Petroleum, Steam and Chemical Hose

Rubber Material Handling Hose

Plastic Material Handling Hose

Food Hose

Ducting

Auto Truck and Marine Hose

Product Information : 5/16" wide 301 Stainless band and housing with 1/4" 401 stainless screw.

TRIDON STAINLESS QUICK RELEASE

Fire Hose

Welding and Other Hose

Cam and Groove

Nipples Menders and Shank Fittings

Clamps

High Pressure Fittings

Mine Fittings

Air Fittings

Valves

Sandblast

Fire Fittings

Pipe Fittings

Sheet Rubber

Index and Technical Information

Size	Fractional Min	Fractional Max	Weight (lbs)	Std Pack Qty	Part #
3"	1-1/2"	3-1/2"	0.08	10	LAS-48
3-1/2"	1"	4"	0.09	10	LAS-56
4-1/2"	2"	5"	0.10	10	LAS-72
5-1/2"	2-1/16"	6"	0.11	10	LAS-88
6"	3-1/2"	6-9/16"	0.11	10	LAS-96
8"	1-3/4"	8-9/16"	0.13	100	LAS-128
9-1/2"	2"	10"	0.15	100	LAS-152
11-3/4"	2-1/16"	12-5/16"	0.17	100	LAS-188



HAMMER LOCK



HAMMERLOCK TOOLS

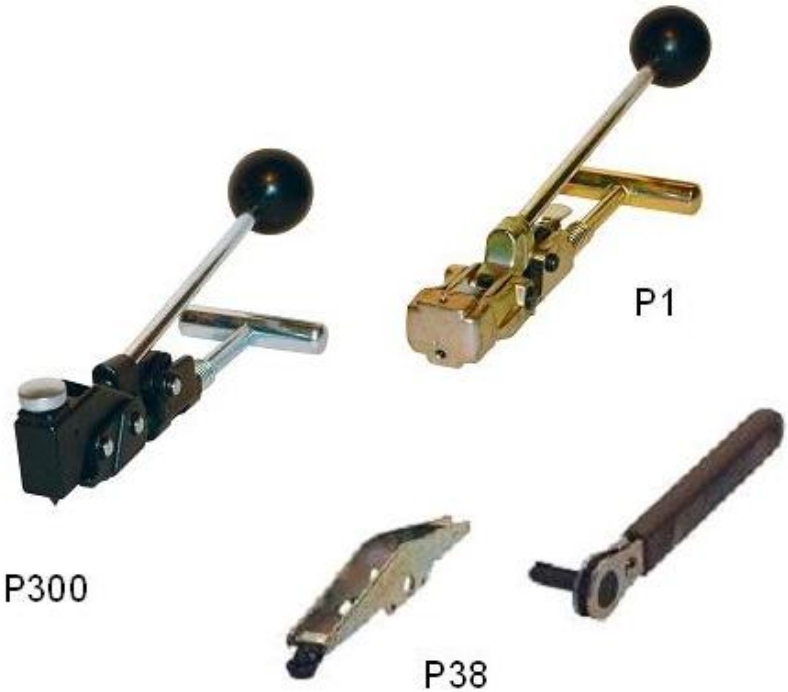

Description	Weight (lbs)	Std Pack Qty	Part #
P1 HAMMER LOCK TOOL	2.80	1	P1
P1000 TOOL	3.00	1	P1000
P300 TOOL	3.30	1	P300
P38 TOOL	1.00	1	P38

- Air and General Purpose Hose
- Water Suction and Discharge Hose
- Petroleum, Steam and Chemical Hose
- Rubber Material Handling Hose
- Plastic Material Handling Hose
- Food Hose
- Ducting
- Auto Truck and Marine Hose
- Fire Hose
- Welding and Other Hose
- Cam and Groove
- Nipples Menders and Shank Fittings
- Clamps
- High Pressure Fittings
- Mine Fittings
- Air Fittings
- Valves
- Sandblast
- Fire Fittings
- Pipe Fittings
- Sheet Rubber
- Index and Technical Information

Air and
General
Purpose
Hose

Water
Suction
and
Discharge
Hose

Petroleum,
Steam and
Chemical
Hose

Rubber
Material
Handling
Hose

Plastic
Material
Handling
Hose

Food Hose

Ducting

Auto
Truck and
Marine
Hose

Fire Hose

Welding
and
Other Hose

Cam
and
Groove

Nipples
Menders
and
Shank
Fittings

Clamps

High
Pressure
Fittings

Mine
Fittings

Air
Fittings

Valves

Sandblast

Fire
Fittings

Pipe
Fittings

Sheet
Rubber

Index
and
Technical
Information

HAMMER LOCK CLAMPS



Description	Weight (lbs)	Std Pack Qty	Part #
1" HAMMER LOCK 5/8" WIDE	0.07	100	CPHL-04
1-1/4" HAMMER LOCK 5/8" WIDE	0.08	100	CPHL-05
1-1/2" HAMMER LOCK 5/8" WIDE	0.08	100	CPHL-06
1-3/4" HAMMER LOCK 5/8" WIDE	0.09	100	CPHL-07
2" HAMMER LOCK 5/8" WIDE	0.10	100	CPHL-08
2-1/4" HAMMER LOCK 5/8" WIDE	0.11	50	CPHL-09
2-1/2" HAMMER LOCK 5/8" WIDE	0.12	50	CPHL-10
2-3/4" HAMMER LOCK 5/8" WIDE	0.12	50	CPHL-11
3" HAMMER LOCK 5/8" WIDE	0.13	50	CPHL-12
3-1/2" HAMMER LOCK 5/8" WIDE	0.15	50	CPHL-14
4" HAMMER LOCK 5/8" WIDE	0.16	25	CPHL-16
4-1/2" HAMMER LOCK 5/8" WIDE	0.18	25	CPHL-18
5" HAMMER LOCK 5/8" WIDE	0.19	25	CPHL-20
6" HAMMER LOCK 5/8" WIDE	0.23	25	CPHL-24
6-1/2" HAMMER LOCK 5/8" WIDE	0.24	25	CPHL-26
7" HAMMER LOCK 5/8" WIDE	0.26	25	CPHL-28
8" HAMMER LOCK 5/8" WIDE	0.29	20	CPHL-32
1" HAMMER LOCK 3/8" WIDE	0.03	100	CPHL-310
1-3/16 HAMMER LOCK 3/8" WIDE	0.03	100	CPHL-03
1-3/8" HAMMER LOCK 3/8" WIDE	0.04	100	CPHL-311
2" HAMMER LOCK 3/8" WIDE	0.05	100	CPHL-316

HAMMER LOCK CLAMPS STAINLESS



Description	Weight (lbs)	Std Pack Qty	Part #
1" HAMMER LOCK STAIN 5/8" WIDE	0.07	100	CPHLS-04
1-1/4" HAMMER LOCK STAIN 5/8" WIDE	0.08	100	CPHLS-05
1-1/2"HAMMER LOCK STAIN 5/8" WIDE	0.08	100	CPHLS-06
1-3/4"HAMMER LOCK STAIN 5/8" WIDE	0.09	100	CPHLS-07
2" HAMMER LOCK STAIN 5/8" WIDE	0.10	100	CPHLS-08
2-1/4"HAMMER LOCK STAIN 5/8" WIDE	0.11	100	CPHLS-09
2-1/2"HAMMER LOCK STAIN 5/8" WIDE	0.12	100	CPHLS-10
2-3/4"HAMMER LOCK STAIN 5/8" WIDE	0.12	50	CPHLS-11
3"HAMMER LOCK STAIN 5/8" WIDE	0.13	50	CPHLS-12
3-1/2"HAMMER LOCK STAIN 5/8" WIDE	0.15	50	CPHLS-14
4"HAMMER LOCK STAIN 5/8" WIDE	0.16	25	CPHLS-16
4-1/2"HAMMER LOCK STAIN 5/8" WIDE	0.18	25	CPHLS-18
5"HAMMER LOCK STAIN 5/8" WIDE	0.19	25	CPHLS-20
6"HAMMER LOCK STAIN 5/8" WIDE	0.23	25	CPHLS-24
7"HAMMER LOCK STAIN 5/8" WIDE	0.26	25	CPHLS-28
8"HAMMER LOCK STAIN 5/8" WIDE	0.29	20	CPHLS-32
1-3/16" HAMMER LOCK STAIN 3/8" WIDE	0.03	100	CPHLS-03
1-3/8"HAMMER LOCK STAIN 3/8" WIDE	0.04	100	CPHLS-311
2"HAMMER LOCK STAIN 3/8"WIDE	0.05	100	CPHLS-316

Air and General Purpose Hose

Water Suction and Discharge Hose

Petroleum, Steam and Chemical Hose

Rubber Material Handling Hose

Plastic Material Handling Hose

Food Hose

Ducting

Auto Truck and Marine Hose

Fire Hose

Welding and Other Hose

Cam and Groove

Nipples Menders and Shank Fittings

Clamps

High Pressure Fittings

Mine Fittings

Air Fittings

Valves

Sandblast

Fire Fittings

Pipe Fittings

Sheet Rubber

Index and Technical Information

PREFORMED CLAMP



Air and
General
Purpose
Hose

Water
Suction
and
Discharge
Hose

Petroleum,
Steam and
Chemical
Hose

Rubber
Material
Handling
Hose

Plastic
Material
Handling
Hose

Food Hose

Ducting

Auto
Truck and
Marine
Hose

Fire Hose

Welding
and
Other Hose

Cam
and
Groove

Nipples
Menders
and
Shank
Fittings

Clamps

High
Pressure
Fittings

Mine
Fittings

Air
Fittings

Valves

Sandblast

Fire
Fittings

Pipe
Fittings

Sheet
Rubber

Index
and
Technical
Information

	Description	Weight (lbs)	Std Pack Qty	Part #
	1" PREFORMED CLAMP 5/8" WIDE	0.07	100	CP-04
	1-1/4" PREFORMED CLAMP 5/8" WIDE	0.08	100	CP-05
	1-1/2" PREFORMED CLAMP 5/8" WIDE	0.08	100	CP-06
	1-3/4" PREFORMED CLAMP 5/8" WIDE	0.09	100	CP-07
	2" PREFORMED CLAMP 5/8" WIDE	0.10	100	CP-08
	2-1/4" PREFORMED CLAMP 5/8" WIDE	0.11	100	CP-09
	2-1/2" PREFORMED CLAMP 5/8" WIDE	0.12	50	CP-10
	2-3/4" PREFORMED CLAMP 5/8" WIDE	0.12	50	CP-11
	3" PREFORMED CLAMP 5/8" WIDE	0.13	50	CP-12
	3-1/2" PREFORMED CLAMP 5/8" WIDE	0.15	50	CP-14
	4" PREFORMED CLAMP 5/8" WIDE	0.16	25	CP-16
	4-1/2" PREFORMED CLAMP 5/8" WIDE	0.18	25	CP-18
	5" PREFORMED CLAMP 5/8" WIDE	0.19	25	CP-20
	6" PREFORMED CLAMP 5/8" WIDE	0.23	25	CP-24
	6-1/2" PREFORMED CLAMP 5/8" WIDE	0.24	25	CP-26
	7" PREFORMED CLAMP 5/8" WIDE	0.26	25	CP-28
	8" PREFORMED CLAMP 5/8" WIDE	0.29	20	CP-32
	1-3/16" PREFORMED CLAMP 3/8" WIDE	0.03	100	CP-03
	1" PREFORMED CLAMP 3/8" WIDE	0.03	100	CP-310
	1-3/8" PREFORMED CLAMP 3/8" WIDE	0.04	100	CP-311
	2" PREFORMED CLAMP 3/8" WIDE	0.05	100	CP-316

PREFORMED CLAMP STAINLESS



Description	Weight (lbs)	Std Pack Qty	Part #
1" PREFORMED CLAMP STAIN. 5/8" WIDE	0.07	100	CPS-04
1-1/4" PREFORMED CLAMP STAIN. 5/8" WIDE	0.08	100	CPS-05
1-1/2" PREFORMED CLAMP STAIN. 5/8" WIDE	0.08	100	CPS-06
1-3/4" PREFORMED CLAMP STAIN. 5/8" WIDE	0.09	100	CPS-07
2" PREFORMED CLAMP STAIN. 5/8" WIDE	0.10	100	CPS-08
2-1/4" PREFORMED CLAMP STAIN. 5/8" WIDE	0.11	100	CPS-09
2-1/2" PREFORMED CLAMP STAIN. 5/8" WIDE	0.12	50	CPS-10
2-3/4" PREFORMED CLAMP STAIN. 5/8" WIDE	0.12	50	CPS-11
3" PREFORMED CLAMP STAIN. 5/8" WIDE	0.13	50	CPS-12
3-1/2" PREFORMED CLAMP STAIN. 5/8" WIDE	0.15	50	CPS-14
4" PREFORMED CLAMP STAIN 5/8" WIDE	0.16	25	CPS-16
4-1/2" PREFORM CLAMP STAIN 5/8" WIDE	0.18	25	CPS-18
5" PREFORMED CLAMP STAIN. 5/8" WIDE	0.19	25	CPS-20
6" PREFORMED CLAMP STAIN. 5/8" WIDE	0.23	25	CPS-24
7" PREFORMED CLAMP STAIN. 5/8" WIDE	0.26	25	CPS-28
8" PREFORMED CLAMP STAIN. 5/8" WIDE	0.29	20	CPS-32
1-3/16" PREFORMED CLAMP STAIN. 3/8" WIDE	0.03	100	CPS-03
1-3/8" PREFORM CLAMP STAIN. 3/8" WIDE	0.04	100	CPS-311
2" PREFORMED CLAMP STAIN 3/8" WIDE	0.05	100	CPS-316

Air and General Purpose Hose

Water Suction and Discharge Hose

Petroleum, Steam and Chemical Hose

Rubber Material Handling Hose

Plastic Material Handling Hose

Food Hose

Ducting

Auto Truck and Marine Hose

Fire Hose

Welding and Other Hose

Cam and Groove

Nipples Menders and Shank Fittings

Clamps

High Pressure Fittings

Mine Fittings

Air Fittings

Valves

Sandblast

Fire Fittings

Pipe Fittings

Sheet Rubber

Index and Technical Information

Air and General Purpose Hose

OPEN END CLAMP

Description	Weight (lbs)	Std Pack Qty	Part #
CPO8 2" OPEN END CLAMP-5/8 WIDE	0.09	100	CPO-08
CPO10 2-1/2" OPEN END CLAMP	0.11	50	CPO-10
CPO12 3" OPEN END CLAMP	0.13	50	CPO-12
CPO14 3-1/2" OPEN END CLAMP	0.16	50	CPO-14
CPO16 4" OPEN END CLAMP	0.18	25	CPO-16
CPO18 4-1/2" OPEN END CLAMP	0.19	25	CPO-18
CPO20 5" OPEN END CLAMP	0.20	25	CPO-20
CPO24 6" OPEN END CLAMP	0.22	25	CPO-24
CPO28 7" OPEN END CLAMP	0.24	25	CPO-28
CPO32 8" OPEN END CLAMP	0.29	25	CPO-32
CPO36 9" OPEN END CLAMP	0.32	25	CPO-36
CPO40 10" OPEN END CLAMP	0.36	25	CPO-40
CPO48 12" OPEN END CLAMP	0.43	20	CPO-48
CPO56 14" OPEN END CLAMP	0.48	20	CPO-56
CPO72 18" OPEN END CLAMP	0.59	20	CPO-72
CPO96 24" OPEN END CLAMP	0.78	20	CPO-96
CPO311 1-3/8 OPEN END CLAMP	0.04	100	CPO-311
CPO316 2"OPEN END CL3/8"WIDE	0.05	100	CPO-316
CPO325 3-3/8 OPEN END CLAMP	0.07	100	CPO-325



Water Suction and Discharge Hose

Petroleum, Steam and Chemical Hose

Rubber Material Handling Hose

Plastic Material Handling Hose

Food Hose

Ducting

Auto Truck and Marine Hose

Fire Hose

Welding and Other Hose

Cam and Groove

Nipples Menders and Shank Fittings

PREFORMED CLAMP STAINLESS AND GALVANIZED J TYPE

Clamps

High Pressure Fittings

Mine Fittings

Air Fittings

Valves

Sandblast

Fire Fittings

Pipe Fittings

Sheet Rubber

Index and Technical Information

Description	Weight (lbs)	Std Pack Qty	Part #
TJ-202 1-3/8"J TYPE PREFORM STAINL	0.05	100	TJ-202
TJ-204 1-1/4"J TYPE PREFORM STAINL	0.09	100	TJ-204
TJ-205 1-1/2"J TYPE PREFORM STAINL	0.10	100	TJ-205
TJ-206 1-3/4"J TYPE PREFORM STAINL	0.11	100	TJ-206
TJ-207 2" J TYPE PREFORMED STAINL	0.12	100	TJ-207
TJ-208 2-1/4"J TYPE PREFORM STAINL	0.13	100	TJ-208
TJ-209 2-1/2"J TYPE PREFORM STAINL	0.14	50	TJ-209
TJ-211 3" J TYPE PREFORMED STAINL	0.19	50	TJ-211
TJ-212 3-1/2" J TYPE PREFORM STAINL	0.22	50	TJ-212
TJ-213 4" J TYPE PREFORMED STAINL	0.26	50	TJ-213
TJ-214 4-1/2"J TYPE PREFORM STAINL	0.26	50	TJ-214
TJ-243 1" J TYPE PREFORMED STAINL	0.04	100	TJ-243
TJ-304 1-1/4"J TYPE GALV PREF CLAMP	0.09	100	TJ-304
TJ-343 1" J TYPE GALV PREF CLAMP	0.04	100	TJ-343



OPEN END CLAMP STAINLESS

Description	Weight (lbs)	Std Pack Qty	Part #
CPO8S 2"OPEN END CLAMP STAINLESS	0.09	100	CPOS-08
CPO10S 2-1/2 OPEN END CLAMP STAINLESS	0.11	100	CPOS-10
CPO12S 3"OPEN END CLAMP STAINLESS	0.10	50	CPOS-12
CPO14S 3-1/2"OPEN END CLAMP STAINL.	0.12	50	CPOS-14
CPO16S 4"OPEN END CLAMP STAINLESS	0.14	50	CPOS-16
CPO18S 4-1/2 OPEN END CLAMP STAINLESS	0.16	50	CPOS-18
CPO20S 5"OPEN END CLAMP STAINLESS	0.18	25	CPOS-20
CPO24S 6"OPEN END CLAMP STAINLESS	0.20	25	CPOS-24
CPO28S 7"OPEN END CLAMP STAINLESS	0.21	25	CPOS-28
CPO32S 8"OPEN END CLAMP STAINLESS	0.29	20	CPOS-32
CPO36S 9"OPEN END CLAMP STAINLESS	0.30	20	CPOS-36
CPO40S 10"OPEN END CLAMP STAINLESS	0.36	20	CPOS-40
CPO48S 12"OPEN END CLAMP STAINLESS	0.33	20	CPOS-48
CPO56S 14"OPEN END CLAMP STAINLESS	0.29	20	CPOS-56
CPO64S 16"OPEN END CLAMP STAINL.	0.44	20	CPOS-64
CPO311S 1-3/8 OPEN END CLAMP STAINLESS	0.04	25	CPOS-311
CPO316S 2"OPEN END CLAMP STAINLESS	0.05	100	CPOS-316
CPO325S 3-3/8 OPEN END CLAMP STAINLESS	0.00	100	CPOS-325



Air and General Purpose Hose
Water Suction and Discharge Hose
Petroleum, Steam and Chemical Hose
Rubber Material Handling Hose
Plastic Material Handling Hose
Food Hose
Ducting
Auto Truck and Marine Hose
Fire Hose
Welding and Other Hose
Cam and Groove
Nipples, Menders and Shank Fittings
Clamps
High Pressure Fittings
Mine Fittings
Air Fittings
Valves
Sandblast
Fire Fittings
Pipe Fittings
Sheet Rubber
Index and Technical Information

STAINLESS BAND

Description	Weight (lbs)	Std Pack Qty	Part #
SC-6 3/8" STAINLESS BAND	3.52	100	SC-06
SC-8 1/2" STAINLESS BAND	6.00	100	SC-08
SC-10 5/8" STAINLESS BAND	7.00	100	SC-10
SC-12 3/4" STAINLESS BAND	8.00	100	SC-12

Product Information : Type 201 stainless steel

STAINLESS BUCKLES

Description	Weight (lbs)	Std Pack Qty	Part #
SB-6 3/8" STAINLESS BUCKLES	0.02	100	SB-06
SB-8 1/2" STAINLESS BUCKLES	0.03	100	SB-08
SB-10 5/8" STAINLESS BUCKLES	0.04	100	SB-10
SB-12 3/4" STAINLESS BUCKLES	0.06	100	SB-12

Product Information : Type 201 stainless steel

Air and General Purpose Hose

P1 HAMMERLOCK PARTS

	Description	Weight (lbs)	Std Pack Qty	Part #
Water Suction and Discharge Hose	PUNCH HEAD FOR P1 TOOL	0.44	1	P1-201
	PUNCH FOR P1 TOOL	0.01	1	P1-202
	SET SCREW FOR P1 TOOL	0.02	1	P1-203
Petroleum, Steam and Chemical Hose	PUNCH HEAD PIN FOR P1 TOOL	0.03	1	P1-204
	PUSHER NOSE FOR P1 TOOL	0.03	1	P1-206
Rubber Material Handling Hose	HOLDING DOG FOR P1 TOOL	0.04	1	P1-207
	PUSHER NOSE PIN FOR P1 TOOL	0.04	1	P1-208
	HOLDING DOG SPRING FOR P1 TOOL	0.01	1	P1-209
Plastic Material Handling Hose	PULLER LINK FOR P1 TOOL	0.03	1	P1-211
	PULLER LINK PIN FOR P1 TOOL	0.03	1	P1-212
Food Hose	PULLING DOG FOR P1 TOOL	0.03	1	P1-214
Ducting	PULLING DOG PIN FOR P1 TOOL	0.03	1	P1-215
	RELEASE LEVER FOR P1 TOOL	0.03	1	P1-216
Auto Truck and Marine Hose	PULLING DOG SPRING FOR P1 TOOL	0.01	1	P1-217
	RELEASE LEVER PIN FOR P1 TOOL	0.01	1	P1-218
Fire Hose	BALL HANDLE ASSEMBLY FOR P1 TOOL	0.02	1	P1-220A
Welding and Other Hose	WRENCH FOR P1 TOOL	0.01	1	P1-224
	225A MALLET	0.00	1	P1-225A
Cam and Groove	FORMED WASHER FOR P1 TOOL	0.02	1	P1-228
	3/8" CLAMP ADAPTER FOR P1 TOOL	0.02	1	P1-229
Nipples, Menders and Shank Fittings	PUSHER PULLER ASSEMBLY FOR P1 TOOL	0.02	1	P1-231A
	RETAINING RINGS FOR P1 TOOL	0.02	1	P1-242

P1000 PARTS

	Description	Weight (lbs)	Std Pack Qty	Part #
High Pressure Fittings	PUNCH FOR P1000 TOOL	0.01	1	P1000-2029
Mine Fittings	PULLER LINK FOR P1000 TOOL	0.02	1	P1000-2119
Air Fittings	PULLING DOG FOR P1000 TOOL	0.04	1	P1000-2149
Valves	RELEASE LEVER FOR P1000 TOOL	0.01	1	P1000-2169

P38 PARTS

	Description	Weight (lbs)	Std Pack Qty	Part #
Pipe Fittings	RATCHET FOR P38 TOOL	0.55	1	P382
Sheet Rubber	PUNCH ASSEMBLY FOR P38 TOOL	0.22	1	P383

Index and Technical Information

TPT TOOLS AND PARTS

Description	Weight (lbs)	Std Pack Qty	Part #
HANDLE FOR TPT-1 TOOL	1.10	1	TPT-01
SPINDLE FOR TPT-1 TOOL	0.04	1	TPT-02
MAIN BEARING FOR TPT-1 TOOL	0.02	1	TPT-03
CUTTER BLADE FOR TPT-1 TOOL	0.22	1	TPT-04
TPT-1 BANDING TOOL	4.19	1	TPT-1
J CLAMP ADAPTER FOR TPT-1 TOOL	0.03	1	TPT-J001



Air and General Purpose Hose

Water Suction and Discharge Hose

Petroleum, Steam and Chemical Hose

Rubber Material Handling Hose

Plastic Material Handling Hose

Food Hose

Ducting

Auto Truck and Marine Hose

Fire Hose

Welding and Other Hose

Cam and Groove

Nipples Menders and Shank Fittings

Clamps

High Pressure Fittings

Mine Fittings

Air Fittings

Valves

Sandblast

Fire Fittings

Pipe Fittings

Sheet Rubber

Index and Technical Information

P300 PARTS

Description	Weight (lbs)	Std Pack Qty	Part #
PUNCH HEAD FOR P300 TOOL	0.37	1	P300-01
SPRING PIN FOR P300 TOOL	0.02	1	P300-02
PUNCH FOR P300 TOOL	0.04	1	P300-03
RETAINING BALL FOR P300 TOOL	0.01	1	P300-04
PUNCH HOLDER FOR P300 TOOL	0.13	1	P300-05
PUSHER NOSE FOR P300 TOOL	0.03	1	P300-07
SPRING FOR P300 TOOL	0.01	1	P300-08
HOLDING DOG FOR P300 TOOL	0.11	1	P300-09
NOSE FOR P300 TOOL	0.44	1	P300-11
HOLDING DOG PIN FOR P300 TOOL	0.03	1	P300-12
RETAINING RING FOR P300 TOOL	0.01	1	P300-13
PIVOT HEAD PIN FOR P300 TOOL	0.04	1	P300-14
SET SCREW FOR P300 TOOL	0.02	1	P300-15
TENSION HANDLE ASSEMBLY FOR P300 TOOL	0.59	1	P300-18
HANDLE BALL FOR P300 TOOL	0.10	1	P300-21
SLIDE FOR P300 TOOL	0.55	1	P300-25
PULLING DOG PIN FOR P300 TOOL	0.04	1	P300-26
PULLING DOG FOR P300 TOOL	0.03	1	P300-27
DOWELL PIN FOR P300 TOOL	0.03	1	P300-28
LINK FOR P300 TOOL	0.04	1	P300-29
SLIDE BAR HANDLE FOR P300 TOOL	0.75	1	P300-32
COMPRESSION SPRING FOR P300 TOOL	0.03	1	P300-34
WASHER FOR P300 TOOL	0.01	1	P300-35

CIRCLE CLAMP



CIRCLE CLAMP 2 EAR

Size	Closed	Open	Weight (lbs)	Std Pack Qty	Part #
1/2"	0.433"	0.512"	.01	100	CC-1113
9/16"	0.512"	0.591"	.01	100	CC-1315
19/32"	0.591"	0.669"	.02	100	CC-1517
5/8"	0.591"	0.708"	.02	100	CC-1518
3/4"	0.669"	0.787"	.02	100	CC-1720
13/16"	0.748"	0.865"	.02	100	CC-1922
7/8"	0.787"	0.905"	.02	100	CC-2023
15/16"	0.866"	0.984"	.02	100	CC-2225
1"	0.905"	1.063"	.02	100	CC-2327
1-1/16"	0.984"	1.012"	.02	100	CC-2528
1-1/8"	1.063"	1.22"	.02	100	CC-2731
1-5/16"	1.22"	1.339"	.02	100	CC-3134
1-7/16"	1.339"	1.457"	.04	100	CC-3437
1-1/2"	1.457"	1.575"	.04	100	CC-3740

- Air and General Purpose Hose
- Water Suction and Discharge Hose
- Petroleum, Steam and Chemical Hose
- Rubber Material Handling Hose
- Plastic Material Handling Hose
- Food Hose
- Ducting
- Auto Truck and Marine Hose
- Fire Hose
- Welding and Other Hose
- Cam and Groove
- Nipples, Menders and Shank Fittings
- Clamps
- High Pressure Fittings
- Mine Fittings
- Air Fittings
- Valves
- Sandblast
- Fire Fittings
- Pipe Fittings
- Sheet Rubber
- Index and Technical Information

OETIKER CLAMP 2 EAR

Air and General Purpose Hose

Water Suction and Discharge Hose

Petroleum, Steam and Chemical Hose

Rubber Material Handling Hose

Plastic Material Handling Hose

Food Hose

Ducting

Auto Truck and Marine Hose

Fire Hose

Welding and Other Hose

Cam and Groove

Nipples, Menders and Shank Fittings

Clamps

High Pressure Fittings

Mine Fittings

Air Fittings

Valves

Sandblast

Fire Fittings

Pipe Fittings

Sheet Rubber

Index and Technical Information

	Size	Closed	Open	Weight (lbs)	Std Pack Qty	Part #
	5/32"	0.122"	0.161"	0.01	100	OET-0041
	11/64"	0.138"	0.177"	0.01	100	OET-0045
	3/16"	0.118"	0.197"	0.01	100	OET-0305
	1/4"	0.197"	0.276"	0.01	100	OET-0507
	5/16"	0.276"	0.354"	0.01	100	OET-0709
	3/8"	0.315"	0.433"	0.01	100	OET-0811
	7/16"	0.354"	0.433"	0.01	100	OET-0911
	1/2"	0.433"	0.512"	0.01	100	OET-1113
	9/16"	0.512"	0.591"	0.01	100	OET-1315
	19/32"	0.591"	0.669"	0.02	100	OET-1517
	5/8"	0.591"	0.708"	0.02	100	OET-1518
	3/4"	0.669"	0.787"	0.02	100	OET-1720
	13/16"	0.748"	0.865"	0.02	100	OET-1922
	7/8"	0.787"	0.905"	0.02	100	OET-2023
	15/16"	0.866"	0.984"	0.02	100	OET-2225
	1"	0.905"	1.063"	0.02	100	OET-2327
	1-1/16"	0.984"	1.012"	0.02	100	OET-2528
	1-1/8"	1.063"	1.220"	0.02	100	OET-2731
	1-5/16"	1.220"	1.339"	0.02	100	OET-3134
	1-7/16"	1.339"	1.457"	0.04	100	OET-3437
	1-1/2"	1.457"	1.575"	0.04	100	OET-3740
	1-5/8"	1.575"	1.693"	0.04	100	OET-4043
	1-3/4"	1.693"	1.811"	0.04	100	OET-4346

Product Information : 1-Ear Clamps, 3-Ear Clamps, Twin Clamps, Clamp Kits, and special tools and fittings are available on request.

OETIKER CLAMP 2 EAR STAINLESS

Size	Closed	Open	Weight (lbs)	Std Pack Qty	Part #
5/32"	0.122"	0.161"	0.01	100	OET-R0041
11/64"	0.138"	0.177"	0.01	100	OET-R0045
3/16"	0.118"	0.197"	0.01	100	OET-R0305
1/4"	0.197"	0.276"	0.01	100	OET-R0507
5/16"	0.276"	0.354"	0.01	100	OET-R0709
3/8"	0.315"	0.433"	0.01	100	OET-R0811
1/2"	0.433"	0.512"	0.01	100	OET-R1113
9/16"	0.512"	0.591"	0.01	100	OET-R1315
19/32"	0.591"	0.669"	0.02	100	OET-R1517
5/8"	0.591"	0.708"	0.02	100	OET-R1518
3/4"	0.669"	0.787"	0.02	100	OET-R1720
13/16"	0.748"	0.865"	0.02	100	OET-R1922
7/8"	0.787"	0.905"	0.02	100	OET-R2023
15/16"	0.866"	0.984"	0.02	100	OET-R2225
1"	0.905"	1.063"	0.02	100	OET-R2327
1-1/16"	0.984"	1.012"	0.02	100	OET-R2528
1-1/8"	1.063"	1.220"	0.02	100	OET-R2731
1-5/16"	1.220"	1.339"	0.03	100	OET-R3134
1-7/16"	1.339"	1.457"	0.04	100	OET-R3437
1-1/2"	1.457"	1.575"	0.03	100	OET-R3740
1-5/8"	1.575"	1.693"	0.04	100	OET-R4043
1-3/4"	1.693"	1.811"	0.04	100	OET-R4346

Product Information : 1-Ear Clamps, 3-Ear Clamps, Twin Clamps, Clamp Kits, and special tools and fittings are available on request.

SIDE JAW PINCER

Description	Weight (lbs)	Part #
OETIKER SIDE JAW PINCER	0.75	OETP-1099

SK 1098 KIT

Description	Weight (lbs)	Part #
OETIKER SK 1098 KIT	3.08	OET-SK1098

Air and General Purpose Hose

Water Suction and Discharge Hose

Petroleum, Steam and Chemical Hose

Rubber Material Handling Hose

Plastic Material Handling Hose

Food Hose

Ducting

Auto Truck and Marine Hose

Fire Hose

Welding and Other Hose

Cam and Groove

Nipples, Menders and Shank Fittings

Clamps

High Pressure Fittings

Mine Fittings

Air Fittings

Valves

Sandblast

Fire Fittings

Pipe Fittings

Sheet Rubber

Index and Technical Information

Air and
General
Purpose
Hose

STRAIGHT JAW PINCER

Water
Suction
and
Discharge
Hose

Description

Weight (lbs)

Part

STRAIGHT JAW PINCER
OETIKER STRAIGHT JAW PINCER

.70
0.70

CCP-1098
OETP-1098



Petroleum,
Steam and
Chemical
Hose

Rubber
Material
Handling
Hose

Plastic
Material
Handling
Hose

Food Hose

Ducting

Auto
Truck and
Marine
Hose

Fire Hose

Welding
and
Other Hose

Cam
and
Groove

Nipples
Menders
and
Shank
Fittings

Clamps

High
Pressure
Fittings

Mine
Fittings

Air
Fittings

Valves

Sandblast

Fire
Fittings

Pipe
Fittings

Sheet
Rubber

Index
and
Technical
Information

M6 MAXI CLAMP LIGHT

Application : Rugged Heavy Duty Wide Band Clamp for use in medium pressure air and water applications



Size	Decimal Min	Decimal Max	Weight (lbs)	Std Pack Qty	Part #
23-25mm	0.87"	1.01"	0.10	100	M6-23
26-28mm	1.02"	1.13"	0.10	100	M6-26
29-31mm	1.14"	1.25"	0.10	100	M6-29
32-35mm	1.26"	1.41"	0.11	100	M6-32
36-39mm	1.42"	1.56"	0.11	100	M6-36
40-43mm	1.57"	1.72"	0.12	100	M6-40
44-47mm	1.73"	1.88"	0.12	100	M6-44
48-51mm	1.89"	2.04"	0.12	100	M6-48
52-55mm	2.05"	2.17"	0.13	100	M6-52
56-59mm	2.20"	2.35"	0.14	100	M6-56
60-63mm	2.36"	2.51"	0.14	100	M6-60
64-67mm	2.52"	2.67"	0.15	100	M6-64
68-73mm	2.68"	2.90"	0.15	100	M6-68

Product Information : Do not use M6 MAXI clamps on wire reinforced or PVC suction hose over 1-1/4" I.D. Use M8 or M10 clamps.

M6 STAINLESS MAXI CLAMP LIGHT

Application : Rugged Heavy Duty Wide Band Clamp for use in medium pressure air and water applications

Size	Decimal Min	Decimal Max	Weight (lbs)	Std Pack Qty	Part #
26-28mm	1.02"	1.13"	0.10	100	M6S-26
29-31mm	1.14"	1.25"	0.10	100	M6S-29
32-35mm	1.26"	1.41"	0.11	100	M6S-32
36-39mm	1.42"	1.56"	0.11	100	M6S-36
44-47mm	1.73"	1.88"	0.12	100	M6S-44
48-51mm	1.89"	2.04"	0.12	100	M6S-48
52-55mm	2.05"	2.17"	0.13	100	M6S-52
56-59mm	2.20"	2.35"	0.14	100	M6S-56
60-63mm	2.36"	2.51"	0.14	100	M6S-60
64-67mm	2.52"	2.67"	0.15	100	M6S-64
68-73mm	2.68"	2.90"	0.15	100	M6S-68



Product Information : Do not use M6 MAXI clamps on wire reinforced or PVC suction hose over 1-1/4" I.D. Use M8 or M10 clamps.

Air and
General
Purpose
Hose

Water
Suction
and
Discharge
Hose

Petroleum,
Steam and
Chemical
Hose

Rubber
Material
Handling
Hose

Plastic
Material
Handling
Hose

Food Hose

Ducting

Auto
Truck and
Marine
Hose

Fire Hose

Welding
and
Other Hose

Cam
and
Groove

Nipples
Menders
and
Shank
Fittings

Clamps

High
Pressure
Fittings

Mine
Fittings

Air
Fittings

Valves

Sandblast

Fire
Fittings

Pipe
Fittings

Sheet
Rubber

Index
and
Technical
Information

M8 MAXI CLAMP STANDARD



Application

: Rugged Heavy Duty Wide Band Clamp for use in medium pressure air and water applications

	Size	Decimal Min	Decimal Max	Weight (lbs)	Std Pack Qty	Part #
Ducting	44-47mm	1.73"	1.88"	0.24	100	M8-44
Auto Truck and Marine Hose	48-51mm	1.89"	2.04"	0.25	100	M8-48
	52-55mm	2.05"	2.17"	0.25	100	M8-52
	56-59mm	2.20"	2.35"	0.26	100	M8-56
Fire Hose	60-63mm	2.36"	2.51"	0.27	100	M8-60
Welding and Other Hose	64-67mm	2.52"	2.67"	0.28	100	M8-64
	68-73mm	2.68"	2.90"	0.30	100	M8-68
Cam and Groove	74-79mm	2.91"	3.14"	0.31	50	M8-74
	80-85mm	3.15"	3.38"	0.31	50	M8-80
Nipples Menders and Shank Fittings	86-91mm	3.39"	3.61"	0.32	50	M8-86
	92-97mm	3.62"	3.85"	0.33	50	M8-92
	98-103mm	3.86"	4.08"	0.33	50	M8-98
Clamps	104-112mm	4.09"	4.44"	0.35	50	M8-104
High Pressure Fittings	113-121mm	4.45"	4.79"	0.36	50	M8-113
	122-130mm	4.80"	5.15"	0.37	25	M8-122
Mine Fittings	131-139mm	5.16"	5.50"	0.37	25	M8-131
	140-148mm	5.51"	5.86"	0.37	25	M8-140
Air Fittings	149-161mm	5.87"	6.37"	0.37	25	M8-149
Valves	162-174mm	6.38"	6.88"	0.37	25	M8-162

M8 MAXI CLAMP STAINLESS

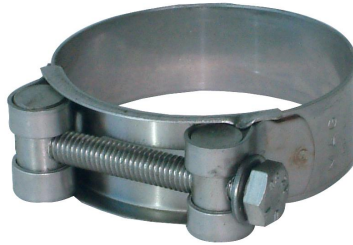

Application

: Rugged Heavy Duty Wide Band Clamp for use in medium pressure air and water applications

Size	Decimal Min	Decimal Max	Weight (lbs)	Std Pack Qty	Part #
32-35mm	1.26"	1.41"	0.22	100	M8S-32
36-39mm	1.42"	1.56"	0.22	100	M8S-36
40-43mm	1.57"	1.72"	0.23	100	M8S-40
44-47mm	1.73"	1.88"	0.24	100	M8S-44
48-51mm	1.89"	2.04"	0.25	100	M8S-48
52-55mm	2.05"	2.17"	0.25	100	M8S-52
56-59mm	2.20"	2.35"	0.26	100	M8S-56
60-63mm	2.36"	2.51"	0.27	100	M8S-60
68-73mm	2.68"	2.90"	0.30	100	M8S-68
64-67mm	2.52"	2.67"	0.28	100	M8S-64
74-79mm	2.91"	3.14"	0.31	50	M8S-74
80-85mm	3.15"	3.38"	0.31	50	M8S-80
86-91mm	3.39"	3.61"	0.32	50	M8S-86
92-97mm	3.62"	3.85"	0.33	50	M8S-92
98-103mm	3.86"	4.08"	0.33	50	M8S-98
113-121mm	4.45"	4.79"	0.36	50	M8S-113
104-112mm	4.09"	4.44"	0.35	50	M8S-104
122-130mm	4.80"	5.15"	0.37	25	M8S-122
131-139mm	5.16"	5.50"	0.37	25	M8S-131
140-148mm	5.51"	5.86"	0.37	25	M8S-140
149-161mm	5.87"	6.37"	0.37	25	M8S-149
162-174mm	6.38"	6.88"	0.37	25	M8S-162

Air and General Purpose Hose

Water Suction and Discharge Hose

Petroleum, Steam and Chemical Hose

Rubber Material Handling Hose

Plastic Material Handling Hose

Food Hose

Ducting

Auto Truck and Marine Hose

Fire Hose

Welding and Other Hose

Cam and Groove

Nipples Menders and Shank Fittings

Clamps

High Pressure Fittings

Mine Fittings

Air Fittings

Valves

Sandblast

Fire Fittings

Pipe Fittings

Sheet Rubber

Index and Technical Information

Air and
General
Purpose
Hose

M10 MAXI CLAMP DOUBLE BOLT

Water
Suction
and
Discharge
Hose



Petroleum,
Steam and
Chemical
Hose

Application : Rugged Heavy Duty Wide Band Clamp for use in medium pressure air and water applications

Rubber
Material
Handling
Hose

Plastic
Material
Handling
Hose

Food Hose

Ducting

Auto
Truck and
Marine
Hose

Fire Hose

Welding
and
Other Hose

Cam
and
Groove

Nipples
Menders
and
Shank
Fittings

Clamps

High
Pressure
Fittings

Mine
Fittings

Air
Fittings

Valves

Sandblast

Fire
Fittings

Pipe
Fittings

Sheet
Rubber

Index
and
Technical
Information

Size	Decimal Min	Decimal Max	Weight (lbs)	Std Pack Qty	Part #
86-91mm	3.39"	3.61"	0.99	50	M10DC-86
92-97mm	3.62"	3.85"	1.04	50	M10DC-92
98-103mm	3.86"	4.08"	1.04	50	M10DC-98
104-112mm	4.09"	4.44"	1.07	50	M10DC-104
113-121mm	4.45"	4.79"	1.08	50	M10DC-113
122-130mm	4.80"	5.15"	1.15	25	M10DC-122
131-139mm	5.16"	5.50"	1.20	25	M10DC-131
140-148mm	5.51"	5.86"	1.23	25	M10DC-140
149-161mm	5.87"	6.37"	1.26	25	M10DC-149
162-174mm	6.38"	6.88"	1.30	25	M10DC-162
175-187mm	6.89"	7.39"	1.37	25	M10DC-175
188-200mm	7.40"	7.86"	1.42	25	M10DC-188
200-220mm	7.87"	8.66"	1.48	25	M10DC-200
220-240mm	8.66"	9.45"	1.64	25	M10DC-220
240-260mm	9.45"	10.24"	1.67	25	M10DC-240
260-280mm	10.24"	11.02"	1.81	25	M10DC-260
280-300mm	11.02"	11.81"	1.85	25	M10DC-280
300-325mm	11.81"	12.80"	1.94	25	M10DC-300
325-350mm	12.80"	13.78"	2.03	25	M10DC-325
350-375mm	13.78"	14.76"	2.11	25	M10DC-350
375-400mm	14.76"	15.75"	2.20	25	M10DC-375
400-425mm	15.75"	16.73"	2.29	25	M10DC-400
425-450mm	16.73"	17.72"	2.38	25	M10DC-425
450-475mm	17.72"	18.70"	2.47	25	M10DC-450

M10 MAXI CLAMP HEAVY



Application

: Rugged Heavy Duty Wide Band Clamp for use in medium pressure air and water applications

Size	Decimal Min	Decimal Max	Weight (lbs)	Std Pack Qty	Part #
68-73mm	2.68"	2.90"	0.59	50	M10-68
74-79mm	2.91"	3.14"	0.61	50	M10-74
80-85mm	3.15"	3.38"	0.62	50	M10-80
86-91mm	3.39"	3.61"	0.64	50	M10-86
92-97mm	3.62"	3.85"	0.66	50	M10-92
98-103mm	3.86"	4.08"	0.69	50	M10-98
104-112mm	4.09"	4.44"	0.72	50	M10-104
113-121mm	4.45"	4.79"	0.74	50	M10-113
122-130mm	4.80"	5.15"	0.77	25	M10-122
131-139mm	5.16"	5.50"	0.80	25	M10-131
140-148mm	5.51"	5.86"	0.84	25	M10-140
149-161mm	5.87"	6.37"	0.88	25	M10-149
162-174mm	6.38"	6.88"	0.90	25	M10-162
175-187mm	6.89"	7.39"	0.96	25	M10-175
188-200mm	7.40"	7.86"	0.98	25	M10-188
201-213mm	7.91"	8.42"	0.97	25	M10-201
214-226mm	8.43"	8.90"	1.06	25	M10-214
227-239mm	8.94"	9.44"	1.15	25	M10-227
240-252mm	9.45"	9.92"	1.23	25	M10-240
248-260mm	9.76"	10.24"	1.32	25	M10-248

Air and General Purpose Hose

Water Suction and Discharge Hose

Petroleum, Steam and Chemical Hose

Rubber Material Handling Hose

Plastic Material Handling Hose

Food Hose

Ducting

Auto Truck and Marine Hose

Fire Hose

Welding and Other Hose

Cam and Groove

Nipples Menders and Shank Fittings

Clamps

High Pressure Fittings

Mine Fittings

Air Fittings

Valves

Sandblast

Fire Fittings

Pipe Fittings

Sheet Rubber

Index and Technical Information

MEGAKLAMP



Size	Decimal Min	Decimal Max	Weight (lbs)	Std Pack Qty	Part #
17-19mm	0.67"	0.75"	0.07	100	MKL-019-SP
20-22mm	0.79"	0.87"	0.07	100	MKL-022-SP
23-25mm	0.87"	0.98"	0.09	100	MKL-025-SP
26-28mm	1.02"	1.10"	0.11	100	MKL-028-SP
29-31mm	1.14"	1.22"	0.11	100	MKL-031-SP
32-35mm	1.26"	1.38"	0.13	100	MKL-035-SP
36-39mm	1.42"	1.54"	0.13	100	MKL-039-SP
40-43mm	1.57"	1.69"	0.13	100	MKL-043-SP
44-47mm	1.73"	1.85"	0.22	100	MKL-047-SP
48-51mm	1.89"	2.01"	0.22	100	MKL-051-SP
52-55mm	2.05"	2.17"	0.22	100	MKL-055-SP
56-59mm	2.20"	2.32"	0.22	100	MKL-059-SP
60-63mm	2.36"	2.48"	0.24	100	MKL-063-SP
64-67mm	2.52"	2.64"	0.24	100	MKL-067-SP
68-73mm	2.68"	2.87"	0.33	50	MKL-073-SP
74-79mm	2.91"	3.11"	0.35	50	MKL-079-SP
80-85mm	3.15"	3.35"	0.35	50	MKL-085-SP
86-91mm	3.39"	3.58"	0.35	50	MKL-091-SP
92-97mm	3.62"	3.82"	0.37	50	MKL-097-SP
98-103mm	3.86"	4.06"	0.40	50	MKL-103-SP
104-112mm	4.09"	4.41"	0.44	50	MKL-112-SP
113-121mm	4.45"	4.76"	0.44	50	MKL-121-SP
122-130mm	4.80"	5.12"	0.44	25	MKL-130-SP
131-139mm	5.16"	5.47"	0.66	25	MKL-139-SP
140-148mm	5.51"	5.83"	0.66	25	MKL-148-SP
149-161mm	5.87"	6.34"	0.77	25	MKL-161-SP
162-174mm	6.38"	6.85"	0.79	25	MKL-174-SP
175-187mm	6.89"	7.36"	0.79	25	MKL-187-SP
188-200mm	7.40"	7.87"	0.79	25	MKL-200-SP
201-213mm	7.91"	8.39"	0.79	25	MKL-213-SP
214-226mm	8.43"	8.90"	0.79	25	MKL-226-SP
227-239mm	8.94"	9.41"	0.88	25	MKL-239-SP
240-252mm	9.45"	9.92"	1.00	25	MKL-252-SP

SPIRAL CLAMP LEFT

Application : Special clamps for use with heavily corrugated suction hose. Left (counter clockwise)



Size	Pitch	Weight (lbs)	Std Pack Qty	Part #
2"	11mm	0.35	100	SC-200L-SP
2-1/2"	11mm	0.37	100	SC-250L-SP
3"	11mm	0.88	70	SC-300L-SP
4"	15mm	1.05	40	SC-400L-SP
5"	15mm	1.87	30	SC-500L-SP
6"	19mm	2.09	20	SC-600L-SP
8"	19mm	2.64	10	SC-800L-SP
10"	19mm	3.52	10	SC-1000L-SP
12"	19mm	4.41	10	SC-1200L-SP

Product Information : To determine left (counter clockwise) or right (clockwise) spiral. Holding the hose, if the helix spirals in a counter clockwise direction away from you, use a left hand clamp, if the helix spirals away in a clockwise direction, use a right hand clamp.

SPIRAL CLAMP RIGHT

Size	Pitch	Weight (lbs)	Std Pack Qty	Part #
2"	11mm	0.35	100	SC-200R-SP
2-1/2"	11mm	0.37	100	SC-250R-SP
3"	11mm	0.88	70	SC-300R-SP
4"	15mm	1.05	40	SC-400R-SP
5"	15mm	1.87	30	SC-500R-SP
6"	19mm	2.09	20	SC-600R-SP
8"	19mm	2.64	10	SC-800R-SP
10"	19mm	3.52	10	SC-1000R-SP
12"	19mm	4.41	10	SC-1200R-SP



Product Information : To determine left (counter clockwise) or right (clockwise) spiral. Holding the hose, if the helix spirals in a counter clockwise direction away from you, use a left hand clamp, if the helix spirals away in a clockwise direction, use a right hand clamp.

HIGH PRESSURE CLAMP

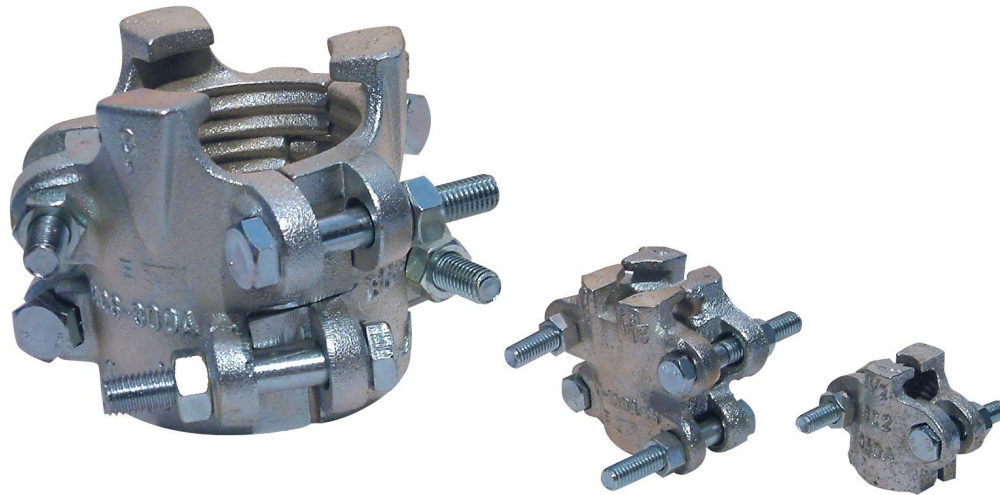

- Air and General Purpose Hose
- Water Suction and Discharge Hose
- Petroleum, Steam and Chemical Hose
- Rubber Material Handling Hose
- Plastic Material Handling Hose
- Food Hose
- Ducting
- Auto Truck and Marine Hose
- Fire Hose
- Welding and Other Hose
- Cam and Groove
- Nipples Menders and Shank Fittings
- Clamps
- High Pressure Fittings
- Mine Fittings
- Air Fittings
- Valves
- Sandblast
- Fire Fittings
- Pipe Fittings
- Sheet Rubber
- Index and Technical Information

2 BOLT HIGH PRESSURE CLAMP



Size	Fractional Min	Fractional Max	Dixon #	Bolt Torque FT LBS	Weight (lbs)	Std Pack Qty	Part #
3/8"	11/16"	7/8"	CD	6	0.18	200	BCQ-038-DP
1/2"	13/16"	15/16"	DD	6	0.31	100	BC2-050-DP
1/2"	15/16"	1-1/16"	B4	12	0.37	100	BC2-050A-DP
1/2"	1-1/16"	1-3/16"	B5	12	0.40	100	BC2-050B-DP
3/4"	1-5/32"	1-9/32"	BU9S	21	0.75	60	BC2-075-DP
3/4"	1-3/16"	1-5/16"	BU9	21	0.77	60	BC2-075A-DP
3/4"	1-5/16"	1-1/2"	B9	21	0.88	60	BC2-075B-DP
3/4"	1-1/2"	1-11/16"	B10	21	1.10	40	BC2-075C-DP

Safety Information : High Pressure clamps are designed to be used with High Pressure couplings. They may be used under some special circumstances with other couplings. Call us for guidance. On some clamps the lug may have to be ground down to achieve optimum clamping on thin wall hose. Consult us for the proper clamp selection for your particular hose.

Air and General Purpose Hose

Water Suction and Discharge Hose

Petroleum, Steam and Chemical Hose

Rubber Material Handling Hose

Plastic Material Handling Hose

Food Hose

Ducting

Auto Truck and Marine Hose

Fire Hose

Welding and Other Hose

Cam and Groove

Nipples Menders and Shank Fittings

Clamps

High Pressure Fittings

Mine Fittings

Air Fittings

Valves

Sandblast

Fire Fittings

Pipe Fittings

Sheet Rubber

Index and Technical Information

4 BOLT HIGH PRESSURE CLAMP



	Size	Fractional Min	Fractional Max	Dixon #	Bolt Torque FT LBS	Weight (lbs)	Std Pack Qty	Part #
	1"	1-7/8"	2-1/16"	B15	21	1.87	24	BC4-100-DP
	1"	1-13/32"	1-9/16"	156	21	1.54	24	BC4-100A-DP
	1"	1-17/32"	1-23/32"	BU14	21	1.65	24	BC4-100B-DP
	1"	1-5/8"	1-27/32"	B14	21	1.93	20	BC4-100C-DP
	1-1/4"	2-1/16"	2-1/4"	B19	40	2.20	20	BC4-125-DP
	1-1/2"	2"	2-7/32"	B22	40	2.31	20	BC4-150-DP
	1-1/2"	2-3/32"	2-9/32"	BU24	40	2.20	20	BC4-150A-DP
	1-1/2"	2-1/4"	2-7/16"	B24	40	2.53	20	BC4-150B-DP
	1-1/2"	2-15/32"	2-23/32"	B25	40	2.64	20	BC4-150C-DP
	2"	2-11/32"	2-17/32"	BU28	60	2.64	20	BC4-200-DP
	2"	2-1/2"	2-25/32"	BU29	60	2.77	20	BC4-200A-DP
	2"	2-3/4"	3-1/16"	B29	60	3.30	16	BC4-200B-DP
	2-1/2"	3-3/32"	3-7/16"	B30	60	3.39	14	BC4-200C-DP
	2-1/2"	3-1/2"	3-15/16"	B34	150	6.96	5	BC4-250-DP
	3"	3-1/2"	3-15/16"	BU-35	150	8.80	5	BC4-300-DP
	3"	3-13/16"	4-3/16"	B35	150	8.80	5	BC4-300A-DP
	3"	4-1/16"	4-7/16"	B39	150	9.00	4	BC4-300B-DP

Safety Information : High Pressure clamps are designed to be used with High Pressure couplings. They may be used under some special circumstances with other couplings. Call us for guidance. On some clamps the lug may have to be ground down to achieve optimum clamping on thin wall hose. Consult us for the proper clamp selection for your particular hose.

6 BOLT HIGH PRESSURE CLAMP

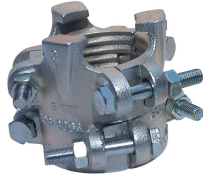

Size	Fractional Min	Fractional Max	Dixon #	Bolt Torque FT LBS	Weight (lbs)	Std Pack Qty	Part #
4"	4-7/8"	5-5/16"	BS49	150	22.00	1	BC6-400A-DP
4"	4-1/4"	4-13/16"	BS39	150	12.65	1	BC6-300A-DP
4"	5-1/4"	5-19/32"	BU49	150	22.00	1	BC6-400B-DP

Safety Information : High Pressure clamps are designed to be used with High Pressure couplings. They may be used under some special circumstances with other couplings. Call us for guidance. On some clamps the lug may have to be ground down to achieve optimum clamping on thin wall hose. Consult us for the proper clamp selection for your particular hose.

Air and General Purpose Hose

Water Suction and Discharge Hose

Petroleum, Steam and Chemical Hose

Rubber Material Handling Hose

Plastic Material Handling Hose

Food Hose

Ducting

Auto Truck and Marine Hose

Fire Hose

Welding and Other Hose

Cam and Groove

Nipples Menders and Shank Fittings

Clamps

High Pressure Fittings

Mine Fittings

Air Fittings

Valves

Sandblast

Fire Fittings

Pipe Fittings

Sheet Rubber

Index and Technical Information

Air and General Purpose Hose

Water Suction and Discharge Hose

Petroleum, Steam and Chemical Hose

Rubber Material Handling Hose

Plastic Material Handling Hose

Food Hose

Ducting

Auto Truck and Marine Hose

Fire Hose

Welding and Other Hose

Cam and Groove

Nipples, Menders and Shank Fittings

Clamps

High Pressure Fittings

Mine Fittings

Air Fittings

Valves

Sandblast

Fire Fittings

Pipe Fittings

Sheet Rubber

Index and Technical Information

HIGH PRESSURE DOUBLE SPUD



Description	Weight (lbs)	Std Pack Qty	Part #
1/2" H.P. DOUBLE SPUD	0.44	200	GDS-050-B
3/4" & 1" H.P. DOUBLE SPUD DUCTILE	1.32	100	GDS-075-B
1-1/4" & 1-1/2" H.P. DOUBLE SPUD	1.40	40	GDS-150-DP
2" H.P. DOUBLE SPUD	1.93	24	GDS-200-DP

Safety Information : High Pressure couplings, together with interlocking High Pressure clamps, is the only recommended method of coupling steam hose, and is the preferred method of coupling air hose that will be used at pressures in excess of 100 psi.

HIGH PRESSURE FEMALE SPUD

Size	Weight (lbs)	Std Pack Qty	Part #
1/2"	0.26	200	GJF-050-SP
3/4"	0.62	100	GJF-075-DP
1"	0.59	100	GJF-100-DP
1-1/4"	1.21	40	GJF-125-DP
1-1/2"	1.05	40	GJF-150-DP
2"	1.38	32	GJF-200-DP
2-1/2"	4.22	12	GJF-250-DP
3"	5.29	10	GJF-300-DP
4"	8.81	5	GJF-400-DP



Safety Information : High Pressure couplings, together with interlocking High Pressure clamps, is the only recommended method of coupling steam hose, and is the preferred method of coupling air hose that will be used at pressures in excess of 100 psi.

HIGH PRESSURE MALE SPUD



Size	Weight (lbs)	Std Pack Qty	Part #
1/2"	0.29	100	GMS-050-DP
3/4"	0.77	60	GMS-075-DP
1"	0.84	50	GMS-100-DP
1-1/4"	1.50	25	GMS-125-DP
1-1/2"	1.67	20	GMS-150-DP
2"	2.42	30	GMS-200-DP

Safety Information : High Pressure couplings, together with interlocking High Pressure clamps, is the only recommended method of coupling steam hose, and is the preferred method of coupling air hose that will be used at pressures in excess of 100 psi.

Air and General Purpose Hose

Water Suction and Discharge Hose

Petroleum, Steam and Chemical Hose

Rubber Material Handling Hose

Plastic Material Handling Hose

Food Hose

Ducting

Auto Truck and Marine Hose

Fire Hose

Welding and Other Hose

Cam and Groove

Nipples, Menders and Shank Fittings

Clamps

High Pressure Fittings

Mine Fittings

Air Fittings

Valves

Sandblast

Fire Fittings

Pipe Fittings

Sheet Rubber

Index and Technical Information

HIGH PRESSURE FEMALE STEM



Size	Weight (lbs)	Std Pack Qty	Part #
1/2"	0.18	200	GJS-050-SP
3/4"	0.42	100	GJS-075-DP
1"	0.53	100	GJS-100-DP
1-1/4"	1.17	40	GJS-125-DP
1-1/2"	1.31	35	GJS-150-DP
2"	1.67	25	GJS-200-DP
2-1/2"	3.74	10	GJS-250-DP
3"	4.68	8	GJS-300-DP
4"	8.81	4	GJS-400-DP

Safety Information : High Pressure couplings, together with interlocking High Pressure clamps, is the only recommended method of coupling steam hose, and is the preferred method of coupling air hose that will be used at pressures in excess of 100 psi.

HIGH PRESSURE MALE STEM

Size	Weight (lbs)	Std Pack Qty	Part #
1/2"	0.18	200	GJM-050-SP
3/4"	0.33	100	GJM-075-SP
1"	0.62	100	GJM-100-SP
1-1/4"	1.24	32	GJM-125-DP
1-1/2"	1.76	25	GJM-150-DP
2"	2.64	20	GJM-200-DP
2-1/2"	4.68	8	GJM-250-DP
3"	6.24	6	GJM-300-DP
4"	11.75	3	GJM-400-DP



Safety Information : High Pressure couplings, together with interlocking High Pressure clamps, is the only recommended method of coupling steam hose, and is the preferred method of coupling air hose that will be used at pressures in excess of 100 psi.

HIGH PRESSURE MENDER



Size	Weight (lbs)	Std Pack Qty	Part #
1/2"	0.20	400	HM-050-DP
3/4"	0.48	100	HM-075-DP
1"	0.73	100	HM-100-DP
1-1/4"	0.40	100	HM-125-DP
1-1/2"	1.59	30	HM-150-DP
2"	2.79	20	HM-200-DP
2-1/2"	4.41	20	HM-250-DP
3"	5.51	6	HM-300-DP
4"	10.46	4	HM-400-DP

Safety Information : High Pressure couplings, together with interlocking High Pressure clamps, is the only recommended method of coupling steam hose, and is the preferred method of coupling air hose that will be used at pressures in excess of 100 psi.

HIGH PRESSURE WING NUT

Description	Weight (lbs)	Std Pack Qty	Part #
1/2" H.P. WING NUT	0.31	200	GJN-050-DP
3/4" & 1" H.P. WING NUT	0.70	60	GJN-075-DP
1-1/2" & 1-1/4"H.P.WING NUT	1.38	35	GJN-150-DP
2" H.P. WING NUT	2.57	24	GJN-200-DP
2-1/2" H.P. WING NUT	4.63	10	GJN-250-DP
3" H.P. WING NUT	5.51	10	GJN-300-DP
4" H.P. WING NUT	10.46	4	GJN-400-DP



Safety Information : High Pressure couplings, together with interlocking High Pressure clamps, is the only recommended method of coupling steam hose, and is the preferred method of coupling air hose that will be used at pressures in excess of 100 psi.

Air and General Purpose Hose

Water Suction and Discharge Hose

Petroleum, Steam and Chemical Hose

Rubber Material Handling Hose

Plastic Material Handling Hose

Food Hose

Ducting

Auto Truck and Marine Hose

Fire Hose

Welding and Other Hose

Cam and Groove

Nipples Menders and Shank Fittings

Clamps

High Pressure Fittings

Mine Fittings

Air Fittings

Valves

Sandblast

Fire Fittings

Pipe Fittings

Sheet Rubber

Index and Technical Information

Air and
General
Purpose
Hose

NPT STEEL HEX NIPPLE

Water
Suction
and
Discharge
Hose

Petroleum,
Steam and
Chemical
Hose

Rubber
Material
Handling
Hose

Plastic
Material
Handling
Hose



Food Hose

Ducting

Auto
Truck and
Marine
Hose

Fire Hose

Welding
and
Other Hose

Cam
and
Groove

Nipples
Menders
and
Shank
Fittings

Clamps

High
Pressure
Fittings

Mine
Fittings

Air
Fittings

Valves

Sandblast

Fire
Fittings

Pipe
Fittings

Sheet
Rubber

Index
and
Technical
Information

Description	Weight (lbs)	Std Pack Qty	Part #
1/4"X 1/8"NPT STEEL HEX NIPPLE	0.05	800	HNC-04*02-SP
1/4"X 1/4"NPT STEEL HEX NIPPLE	0.06	800	HNC-04*04-SP
1/4"X 3/8"NPT STEEL HEX NIPPLE	0.08	800	HNC-04*06-SP
3/8"X 1/4"NPT STEEL HEX NIPPLE	0.09	400	HNC-06*04-SP
3/8"X 3/8"NPT STEEL HEX NIPPLE	0.08	300	HNC-06*06-SP
3/8"X 1/2"NPT STEEL HEX NIPPLE	0.18	400	HNC-06*08-SP
1/2"X 1/4"NPT STEEL HEX NIPPLE	0.13	200	HNC-08*04-SP
1/2"X 3/8"NPT STEEL HEX NIPPLE	0.13	200	HNC-08*06-SP
1/2"X 1/2"NPT STEEL HEX NIPPLE	0.18	200	HNC-08*08-SP
1/2"X 3/4"NPT STEEL HEX NIPPLE	0.28	200	HNC-08*12-SP
3/4"X 1/2"NPT STEEL HEX NIPPLE	0.33	100	HNC-12*08-SP
3/4"X 3/4"NPT STEEL HEX NIPPLE	0.33	100	HNC-12*12-SP
3/4"X 1"NPT STEEL HEX NIPPLE	0.48	100	HNC-12*16-SP
1"X 3/4"NPT STEEL HEX NIPPLE	0.46	100	HNC-16*12-SP
1"X 1"NPT STEEL HEX NIPPLE	0.62	100	HNC-16*16-SP

Safety Information : Hex Nipples and Universal quick acting couplings may be used with air hose for most applications. We recommend that High Pressure clamps are used with these couplings for maximum security.

EXTRA LONG MINE JOINER

Size	Weight (lbs)	Std Pack Qty	Part #
1"	0.48	50	MXJ-100-SP
1-1/4"	0.65	50	MXJ-125-SP
1-1/2"	0.81	50	MXJ-150-SP
2"	1.12	50	MXJ-200-SP



MINE SPUD



Description	Weight (lbs)	Part #
3/8"FEM X 1"MALE MINE SPUD	0.33	MSP-038F-100M
3/8"MALE X 1"MALE MINE SPUD	0.42	MSP-038M-100M
1/2"FEM X 1"MALE MINE SPUD	0.33	MSP-050F-100M
1/2"MALE X 1"MALE MINE SPUD	0.42	MSP-050M-100M
3/4"FEM X 1"MALE MINE SPUD	0.24	MSP-075F-100M
1"FEM X 1"MALE MINE SPUD	0.51	MSP-100F-100M

MINE JOINER

Size	Weight (lbs)	Std Pack Qty	Part #
1/2"	0.07	400	MJ-050-SP
3/4"	0.15	200	MJ-075-SP
1"	0.26	100	MJ-100-SP
1-1/4"	0.38	100	MJ-125-SP
1-1/2"	0.48	80	MJ-150-SP
2"	0.70	70	MJ-200-SP



MINE NUT

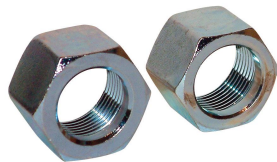

Description	Weight (lbs)	Part #
1/2" MINE HEX NUT	0.13	MN-050-SP
1" MINE NUT	0.23	MN-100-SP
1-1/4" MINE HEX NUT	0.26	MN-125-DP
1-1/2" MINE HEX NUT	0.93	MN-150-DP
2" MINE HEX NUT	1.10	MN-200-DP
1"x1-5/8" LARGE HEX MINE NUT	0.34	MNL-100-SP
1" MINE WING NUT	0.33	MWN-100-DP

Air and General Purpose Hose

MINE STEM

Water Suction and Discharge Hose

Description	Weight (lbs)	Part #
1/2"X1/2" MINE STEM	0.25	MS-050-050-SP
1/2"X1" MINE STEM	0.25	MS-050-100-SP
3/4"X1" MINE STEM	0.32	MS-075-SP
1" MINE STEM	0.35	MS-100-SP
1-1/4" MINE STEM	0.18	MS-125-SP
1-1/2" MINE STEM	0.79	MS-150-DP
2" MINE STEM	1.40	MS-200-DP



Petroleum, Steam and Chemical Hose

Rubber Material Handling Hose

Plastic Material Handling Hose

CHAMF THREADED NIPPLE

Food Hose



Description	Weight (lbs)	Part #
1" CHAMF THREADED NIPPLE	0.40	PN-100T
1" SCHED 40 CHAMF THREAD NIP PLATED	0.44	PN-100T40
1" SCHED 40 CHAMF THREAD NIP PLAIN	0.44	PNB-100T40

Ducting

Auto Truck and Marine Hose

Fire Hose

Welding and Other Hose

EXTRA LONG MINE STEM

Size	Weight (lbs)	Std Pack Qty	Part #
2"	2.39	50	MSXL-200-DP



Cam and Groove

Nipples, Menders and Shank Fittings

Clamps

High Pressure Fittings

Mine Fittings

Air Fittings

Valves

Sandblast

Fire Fittings

Pipe Fittings

Sheet Rubber

Index and Technical Information

Safety Information : For air use on 1/2"-1" sizes only. To avoid injury do not use with steam hose

UNIVERSAL FEMALE END

Gasket Material : NBR



Size	Max Operating PSI (70F)	Weight (lbs)	Std Pack Qty	Part #
3/8"	150	0.33	25	FE-038-DP
1/2"	150	0.42	25	FE-050-DP
3/4"	150	0.40	25	FE-075-DP
1"	150	0.46	25	FE-100-DP
1-1/4"	150	1.40	10	FE-125-DP
1-1/2"	150	1.47	10	FE-150-DP
2"	150	1.62	10	FE-200-DP

UNIVERSAL MALE END

Gasket Material : NBR

Size	Max Operating PSI (70F)	Weight (lbs)	Std Pack Qty	Part #
1/2"	150	0.40	25	ME-050-DP
3/4"	150	0.46	25	ME-075-DP
1"	150	0.55	25	ME-100-DP



UNIVERSAL HOSE END

Gasket Material : NBR

Size	Max Operating PSI (70F)	Weight (lbs)	Std Pack Qty	Part #
3/8"	150	0.35	25	HE-038-DP
1/2"	150	0.42	25	HE-050-DP
3/4"	150	0.46	25	HE-075-DP
1"	150	0.62	25	HE-100-DP
1-1/4"	150	1.59	10	HE-125-DP
1-1/2"	150	1.87	10	HE-150-DP
2"	150	2.42	10	HE-200-DP



Air and General Purpose Hose

Water Suction and Discharge Hose

Petroleum, Steam and Chemical Hose

Rubber Material Handling Hose

Plastic Material Handling Hose

Food Hose

Ducting

Auto Truck and Marine Hose

Fire Hose

Welding and Other Hose

Cam and Groove

Nipples Menders and Shank Fittings

Clamps

High Pressure Fittings

Mine Fittings

Air Fittings

Valves

Sandblast

Fire Fittings

Pipe Fittings

Sheet Rubber

Index and Technical Information

Air and General Purpose Hose

UNIVERSAL FEMALE END STAINLESS

Gasket Material : NBR

Size	Max Operating PSI (70F)	Weight (lbs)	Std Pack Qty	Part #
1/2"	150	0.44	25	FE-050-SS
3/4"	150	0.55	25	FE-075-SS
1"	150	0.66	25	FE-100-SS



Water Suction and Discharge Hose

Petroleum, Steam and Chemical Hose

Rubber Material Handling Hose

UNIVERSAL MALE END STAINLESS

Gasket Material : NBR

Size	Max Operating PSI (70F)	Weight (lbs)	Std Pack Qty	Part #
1/2"	150	0.44	25	ME-050-SS
3/4"	150	0.55	25	ME-075-SS
1"	150	0.66	25	ME-100-SS



Plastic Material Handling Hose

Food Hose

Ducting

Auto Truck and Marine Hose

Fire Hose

UNIVERSAL HOSE END STAINLESS

Gasket Material : NBR

Size	Max Operating PSI (70F)	Weight (lbs)	Std Pack Qty	Part #
1/2"	150	0.44	25	HE-050-SS
3/4"	150	0.57	25	HE-075-SS
1"	150	0.66	25	HE-100-SS



Welding and Other Hose

Cam and Groove

Nipples, Menders and Shank Fittings

Clamps

High Pressure Fittings

UNIVERSAL FEMALE END BRASS

Gasket Material : NBR

Size	Max Operating PSI (70F)	Weight (lbs)	Std Pack Qty	Part #
3/8"	150	0.44	25	FE-038-B
1/2"	150	0.44	25	FE-050-B
3/4"	150	0.55	25	FE-075-B
1"	150	0.55	25	FE-100-B



Mine Fittings

Air Fittings

Valves

Sandblast

Fire Fittings

Pipe Fittings

Sheet Rubber

Index and Technical Information

UNIVERSAL MALE END BRASS

Gasket Material : NBR



Size	Max Operating PSI (70F)	Weight (lbs)	Std Pack Qty	Part #
3/8"	150	0.35	25	ME-038-B
1/2"	150	0.46	25	ME-050-B
3/4"	150	0.55	25	ME-075-B
1"	150	0.59	25	ME-100-B

UNIVERSAL HOSE END BRASS

Gasket Material : NBR

Size	Max Operating PSI (70F)	Weight (lbs)	Std Pack Qty	Part #
3/8"	150	0.37	25	HE-038-B
1/2"	150	0.44	25	HE-050-B
3/4"	150	0.55	25	HE-075-B
1"	150	0.66	25	HE-100-B



UNIVERSAL BLANK END

Gasket Material : NBR



Description	Max Operating PSI (70F)	Weight (lbs)	Part #
UNIVERSAL BLANK END	150	0.42	BE-300-DP

Safety Information : For air use on 1/2"-1" sizes only. To avoid injury do not use with steam hose

UNIVERSAL BLANK END STAINLESS

Gasket Material : NBR

Description	Max Operating PSI (70F)	Weight (lbs)	Part #
UNIVERSAL BLANK END STAINLESS	150	0.51	BE-300-SS



Safety Information : For air use on 1/2"-1" sizes only. To avoid injury do not use with steam hose

Air and General Purpose Hose

Water Suction and Discharge Hose

Petroleum, Steam and Chemical Hose

Rubber Material Handling Hose

Plastic Material Handling Hose

Food Hose

Ducting

Auto Truck and Marine Hose

Fire Hose

Welding and Other Hose

Cam and Groove

Nipples, Menders and Shank Fittings

Clamps

High Pressure Fittings

Mine Fittings

Air Fittings

Valves

Sandblast

Fire Fittings

Pipe Fittings

Sheet Rubber

Index and Technical Information

Air and General Purpose Hose

UNIVERSAL TRIPLE CONNECTOR

Gasket Material : NBR



Description	Max Operating PSI (70F)	Weight (lbs)	Part #
UNIVERSAL TRIPLE CONNECTOR	150	1.10	UW-300-DP

Water Suction and Discharge Hose

Petroleum, Steam and Chemical Hose

Rubber Material Handling Hose

UNIVERSAL WASHER

Description	Weight (lbs)	Part #
UNIVERSAL WASHER LARGE	0.02	UG-4-R
UNIVERSAL WASHER SMALL	0.01	UG-2-R



Plastic Material Handling Hose

Food Hose

Ducting

Auto Truck and Marine Hose

UNIVERSALS SAFETY CLIP

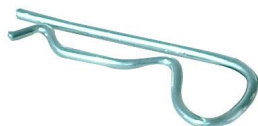

Description	Weight (lbs)	Part #
SAFETY PIN FOR UNIVERSALS	0.01	US-O-P
SAFETY CLIP FOR UNIVERSALS	0.01	US-O-S

Fire Hose

Welding and Other Hose

Cam and Groove

Nipples, Menders and Shank Fittings

Clamps

High Pressure Fittings

Mine Fittings

Air Fittings

Valves

Sandblast

Fire Fittings

Pipe Fittings

Sheet Rubber

Index and Technical Information

Air and General Purpose Hose

Water Suction and Discharge Hose

Petroleum, Steam and Chemical Hose

Rubber Material Handling Hose

Plastic Material Handling Hose

Food Hose

Ducting

Auto Truck and Marine Hose

Fire Hose

Welding and Other Hose

Cam and Groove

Nipples Menders and Shank Fittings

Clamps

High Pressure Fittings

Mine Fittings

Air Fittings

Valves

Sandblast

Fire Fittings

Pipe Fittings

Sheet Rubber

Index and Technical Information

NATIONAL SERIES A COUPLING

Size	Thor #	Dixon #	Weight (lbs)	Std Pack Qty	Part #
1/2"	2071	PFL8	0.66	50	FLS-08
3/4"	22081	PFL12	0.57	50	FLS-12
3/8"	2077	PF6	0.29	50	FS-06
1/2"	2078	PF8	0.44	50	FS-08
3/4"	2079	PF12	0.40	50	FS-12
1"	2080	PF16	0.42	50	FS-16
3/8"	101049	PML6	0.46	50	MLS-06
1/2"	72569	PML8	0.46	50	MLS-08
3/4"	22434	PML12	0.66	50	MLS-12
3/8"	2073	PM6	0.33	50	MS-06
1/2"	2074	PM8	0.33	50	MS-08
3/4"	2075	PM12	0.44	50	MS-12
1"	2076	PM16	0.64	50	MS-16



NATIONAL SERIES A HOSE END



Size	Thor #	Dixon #	Weight (lbs)	Std Pack Qty	Part #
3/8"	2070	PHL6	0.51	50	NHS-06
1/2"	2071	PHL8	0.55	50	NHS-08
3/4"	2072	PHL12	0.55	50	NHS-12
1"	22657	PHL16	0.97	50	NHS-16

NATIONAL SERIES A BRASS

Size	Weight (lbs)	Std Pack Qty	Part #
3/4"	0.46	50	FB-12
3/4"	0.51	50	MB-12
1/2"	0.62	50	NHB-08
3/4"	0.00	50	NHB-12

Air and General Purpose Hose

NATIONAL SERIES B FEMALE HEAD X FEMALE NPT



Size	Dixon #	Weight (lbs)	Std Pack Qty	Part #
3/8"	QM101	0.50	50	BFF-06
1/2"	QM102	0.48	50	BFF-08
3/4"	QM103	0.40	50	BFF-12

Water Suction and Discharge Hose

Petroleum, Steam and Chemical Hose

Rubber Material Handling Hose

Plastic Material Handling Hose

Food Hose

Ducting

Auto Truck and Marine Hose

Fire Hose

Welding and Other Hose

Cam and Groove

Nipples, Menders and Shank Fittings

Clamps

High Pressure Fittings

Mine Fittings

Air Fittings

Valves

Sandblast

Fire Fittings

Pipe Fittings

Sheet Rubber

Index and Technical Information

NATIONAL SERIES B FEMALE HEAD X MALE NPT

Size	Dixon #	Weight (lbs)	Std Pack Qty	Part #
3/8"	QM61	0.32	50	BFM-06
1/2"	QM62	0.33	50	BFM-08
3/4"	QM63	0.36	50	BFM-12



NATIONAL SERIES B FEMALE HEAD X SHANK

Size	Dixon #	Weight (lbs)	Std Pack Qty	Part #
3/8"	QM21	0.34	50	BFH-06
1/2"	QM22	0.38	50	BFH-08
3/4"	QM23	0.41	50	BFH-12



NATIONAL SERIES B MALE HEAD X FEMALE NPT

Size	Dixon #	Weight (lbs)	Std Pack Qty	Part #
3/8"	QM81	0.58	50	BMF-06
1/2"	QM82	0.76	50	BMF-08
3/4"	QM83	0.65	50	BMF-12



NATIONAL SERIES B MALE HEAD X MALE NPT

Description	Dixon #	Weight (lbs)	Std Pack Qty	Part #
3/8" MALE HEAD X MALE NPT	QM41	0.56	50	BMM-06
1/2" MALE HEAD X MALE NPT	QM42	0.57	50	BMM-08
1/2" MALE LOCKING HEAD X MALE NPT	QM66	0.64	50	BMM-08LN
3/4" MALE HEAD X MALE NPT	QM43	0.61	50	BMM-12
3/4" MALE HEAD X MALE NPT LN	QM88	0.65	50	BMM-12LN



Product Information : Suffix of LN indicates a part with locking nut

NATIONAL SERIES B MALE HEAD X SHANK

Size	Dixon #	Weight (lbs)	Std Pack Qty	Part #
3/8"	QM2	0.60	50	BMH-06
1/2"	QM3	0.65	50	BMH-08
1/2"	QM33	0.63	50	BMH-08LN
3/4"	QM4	0.61	50	BMH-12
3/4"	QM44	0.64	50	BMH-12LN



Product Information : Suffix of LN indicates a part with locking nut

NATIONAL GASKET

Description	Std Pack Qty	Part #
G-100 GASKET FOR A-SERIES	50	NAT-G-100
G-300 GASKET FOR B-SERIES	50	NAT-G-300

VITON GASKET FOR A SERIES

Description	Dixon #	Std Pack Qty	Part #
G-200 VITON GASKET FOR A-SER	452963	50	NAT-G-200

LOCKING KEY EXCLUDING MLS,FLS,FLS

Description	Std Pack Qty	Part #
LOCKING KEY EXC MLS12,FLS8,FLS12	50	NAT-200-S

LOCKING KEY MLS,FLS,FLS

Description	Std Pack Qty	Part #
MLS-12,FLS-8,FLS-12 LOCK KEY	50	NAT-201-S

SPRING LOCK FOR NATIONAL CPLG

Description	Std Pack Qty	Part #
SPRING LOCK FOR NAT CPLG	50	NAT-203-W

Air and General Purpose Hose

Water Suction and Discharge Hose

Petroleum, Steam and Chemical Hose

Rubber Material Handling Hose

Plastic Material Handling Hose

Food Hose

Ducting

Auto Truck and Marine Hose

Fire Hose

Welding and Other Hose

Cam and Groove

Nipples Menders and Shank Fittings

Clamps

High Pressure Fittings

Mine Fittings

Air Fittings

Valves

Sandblast

Fire Fittings

Pipe Fittings

Sheet Rubber

Index and Technical Information

THREADED CAST IRON FLANGE 125 - 150#



Size	Weight (lbs)	Std Pack Qty	Part #
2"	4.00	1	FL-200
2-1/2"	5.00	1	FL-250
3"	7.00	1	FL-300
4"	11.00	1	FL-400
5"	14.00	1	FL-500
6"	17.00	1	FL-600
8"	28.00	1	FL-800
10"	36.00	1	FL-1000
12"	46.00	1	FL-1200

FLANGE GASKET

Description	Part #
2" FLANGE GASKET 1/16" THICK	FLG-200-006
2" FLANGE GASKET 1/8" THICK	FLG-200-013
2-1/2" FLANGE GASKET 1/8" THICK	FLG-250-013
3" FLANGE GASKET 1/16" THICK	FLG-300-006
3" FLANGE GASKET 1/8" THICK	FLG-300-013
4" FLANGE GASKET 1/16" THICK	FLG-400-006
4" FLANGE GASKET 1/8" THICK	FLG-400-013
5" FLANGE GASKET 1/8" THICK	FLG-500-013
6" FLANGE GASKET 1/16" THICK	FLG-600-006
6" FLANGE GASKET 1/8" THICK	FLG-600-013
8" FLANGE GASKET 1/16" THICK	FLG-800-006
8" FLANGE GASKET 1/8" THICK	FLG-800-013
10" FLANGE GASKET 1/16" THICK	FLG-1000-006
10" FLANGE GASKET 1/8" THICK	FLG-1000-013
12" FLANGE GASKET 1/16" THICK	FLG-1200-006
12" FLANGE GASKET 1/8" THICK	FLG-1200-013

Product Information : Suffix on part number indicates gasket thickness. -006 = 1/16" thick. -013 = 1/8" thick.

Air and General Purpose Hose

Water Suction and Discharge Hose

Petroleum, Steam and Chemical Hose

Rubber Material Handling Hose

Plastic Material Handling Hose

Food Hose

Ducting

Auto Truck and Marine Hose

Fire Hose

Welding and Other Hose

Cam and Groove

Nipples, Menders and Shank Fittings

Clamps

High Pressure Fittings

Mine Fittings

Air Fittings

Valves

Sandblast

Fire Fittings

Pipe Fittings

Sheet Rubber

Index and Technical Information

LARGE SAFETYCHECK FOR HOSE/HOSE AND HOSE/TOOL

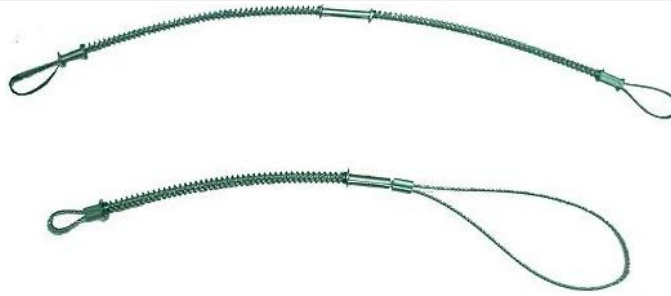

Description	Weight (lbs)	Std Pack Qty	Part #
SAFETYCHECK LARGE 1-1/2"-3"HOSE,37" LONG	1.30	50	WHIP-L
SAFETYCHECK LARGE 1-1/2"-3"TOOL	1.30	50	WHIP-LT

MEDIUM SAFETYCHECK FOR HOSE/HOSE



Description	Weight (lbs)	Std Pack Qty	Part #
SAFETYCHECK MEDIUM 1-1/2"-3"HOSE,24"LONG	1.00	100	WHIP-M

SMALL SAFETYCHECK FOR HOSE/HOSE AND HOSE/TOOL

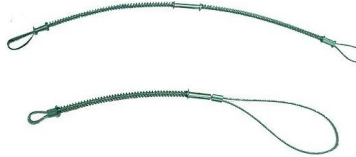

Description	Weight (lbs)	Std Pack Qty	Part #
SAFETYCHECK SMALL 1/2"-1-1/4"HOSE,22" LG	0.25	100	WHIP-S
SAFETYCHECK SMALL 1/2"-1-1/4"TOOL	0.25	100	WHIP-ST

PLASTIC FOG NOZZLE NPS



Size	Weight (lbs)	Std Pack Qty	Part #
1"	0.44	100	FN-100
1-1/2"	0.48	100	FN-150
2"	0.57	100	FN-200

PLASTIC FOG NOZZLE GHT

Size	Weight (lbs)	Std Pack Qty	Part #
3/4"	0.44	100	FN-075



Air and General Purpose Hose

Water Suction and Discharge Hose

Petroleum, Steam and Chemical Hose

Rubber Material Handling Hose

Plastic Material Handling Hose

Food Hose

Ducting

Auto Truck and Marine Hose

Fire Hose

Welding and Other Hose

Cam and Groove

Nipples Menders and Shank Fittings

Clamps

High Pressure Fittings

Mine Fittings

Air Fittings

Valves

Sandblast

Fire Fittings

Pipe Fittings

Sheet Rubber

Index and Technical Information

GREEN ABS FOG NOZZLE GHT

Size	Weight (lbs)	Std Pack Qty	Part #
3/4"	0.44	100	FN-075G



PLASTIC FOG NOZZLE GASKET

Size	Weight (lbs)	Std Pack Qty	Part #
1-1/2"	0.01	100	FNG-150

BRASS NOZZLE



Description	Weight (lbs)	Std Pack Qty	Part #
3/4"SPECIAL BRASS NOZZLE NPS	0.33	50	HN-075-B
1" BRASS NOZZLE	0.73	50	HN-100-B
1-1/4" BRASS NOZZLE	0.94	50	HN-125-B
1-1/2" BRASS NOZZLE	1.15	50	HN-150-B
2" BRASS NOZZLE	1.72	50	HN-200-B
3/4"BRASS NOZZLE GHT	0.35	1	HNT-075-B

CSA/NPT BRASS HYDRANT ADAPTER

Description	Weight (lbs)	Std Pack Qty	Part #
2-1/2"CSA X 1-1/2"NPT HYDR ADAPT	0.88	25	FCR-2515T-B
2-1/2"CSA X 2"NPT HYDR ADAPT	0.99	25	FCR-2520T-B



Air and General Purpose Hose

MALE X MALE SWIVEL PRESSURE WASHER SET

Water Suction and Discharge Hose



Description	Std Pack Qty	Part #
3/8" MALE X MALE SWIVEL PW SET	1	PWB-038-FITT

Petroleum, Steam and Chemical Hose

Solid

Swivel

BRASS BARB MALE SWIVEL

Rubber Material Handling Hose

Description	Weight (lbs)	Part #
1/4"X 1/4"BRASS MALE SWIVEL BARB	0.07	BRMS-04*04
3/8"X 1/4"BRASS MALE SWIVEL BARB	0.09	BRMS-06*04
3/8"X 3/8"BRASS MALE SWIVEL BARB	0.11	BRMS-06*06
1/2"X 1/2"BRASS MALE SWIVEL BARB	0.15	BRMS-08*08

Plastic Material Handling Hose

Food Hose

Ducting

Product Information : Part number description indicates Hose x Male NPT

Auto Truck and Marine Hose

BRASS BARB FEM

Fire Hose

Description	Weight (lbs)	Part #
1/4"X 1/4"FEM BRASS BARB	0.06	BRF-04*04
5/16"X 1/4"FEM BRASS BARB	0.07	BRF-05*04
3/8"X 1/4"FEM BRASS BARB	0.05	BRF-06*04
3/8"X 3/8"FEM BRASS BARB	0.09	BRF-06*06
1/2"X 1/2"FEM BRASSBARB	0.13	BRF-08*08
3/8"X1/4"FEM BRASS BARB SWIVEL	0.05	BRFS-06*04

Welding and Other Hose

Cam and Groove

Nipples Menders and Shank Fittings

Product Information : Part number description indicates Hose x Female NPT. BRF(S) indicates swivel.

Clamps

High Pressure Fittings

Mine Fittings

Air Fittings

Valves

Sandblast

Fire Fittings

Pipe Fittings

Sheet Rubber

Index and Technical Information

BRASS BARB MALE SOLID

Description	Weight (lbs)	Part #
1/4"X 1/8"SOLID BRASS MALE BARB	0.06	BRM-04*02
1/4"X 1/4"SOLID BRASS MALE BARB	0.04	BRM-04*04
1/4"X 3/8"SOLID BRASS MALE BARB	0.08	BRM-04*06
5/16"X 1/4"SOLID BRASS MALE BARB	0.04	BRM-05*04
3/8"X 1/4"SOLID BRASS MALE BARB	0.05	BRM-06*04
3/8"X 3/8"SOLID BRASS MALE BARB	0.07	BRM-06*06
3/8"X 1/2"SOLID BRASS MALE BARB	0.11	BRM-06*08
1/2"X 1/4"SOLID BRASS MALE BARB	0.07	BRM-08*04
1/2"X 3/8"SOLID BRASS MALE BARB	0.07	BRM-08*06
1/2"X 1/2"SOLID BRASS MALE BARB	0.11	BRM-08*08
1/2"X 3/4"SOLID BRASS MALE BARB	0.17	BRM-08*12
3/4"X 3/4"SOLID BRASS MALE BARB	0.18	BRM-12*12

Product Information : Part number description indicates Hose x Male NPT

Air and
General
Purpose
Hose

Water
Suction
and
Discharge
Hose

Petroleum,
Steam and
Chemical
Hose

Rubber
Material
Handling
Hose

Plastic
Material
Handling
Hose

Food Hose

Ducting

Auto
Truck and
Marine
Hose

Fire Hose

Welding
and
Other Hose

Cam
and
Groove

Nipples
Menders
and
Shank
Fittings

Clamps

High
Pressure
Fittings

Mine
Fittings

Air
Fittings

Valves

Sandblast

Fire
Fittings

Pipe
Fittings

Sheet
Rubber

Index
and
Technical
Information

STRAINERS

Air and General Purpose Hose

Water Suction and Discharge Hose

Petroleum, Steam and Chemical Hose

Rubber Material Handling Hose

Plastic Material Handling Hose

Food Hose

Ducting

Auto Truck and Marine Hose

Fire Hose

Welding and Other Hose

Cam and Groove

Nipples Menders and Shank Fittings

Clamps

High Pressure Fittings

Mine Fittings

Air Fittings

Valves

Sandblast

Fire Fittings

Pipe Fittings

Sheet Rubber

Index and Technical Information

STRAINER POLYPROPYLENE



Size	Weight (lbs)	Std Pack Qty	Part #
1-1/2"	0.33	50	SP-150-PP
2"	0.33	50	SP-200-PP

STRAINER ROUND HOLE

Size	Weight (lbs)	Std Pack Qty	Part #
1-1/2"	1.31	32	SR-150-SP
2"	2.08	18	SR-200-SP
3"	2.81	18	SR-300-SP
4"	2.81	18	SR-400-SP
6"	5.51	6	SR-600-SP



STRAINER SQUARE HOLE

Size	Weight (lbs)	Std Pack Qty	Part #
1-1/2"	1.47	32	SS-150-SP
2"	1.55	32	SS-200-SP
2-1/2"	1.98	18	SS-250-SP
3"	2.20	18	SS-300-SP
4"	4.68	18	SS-400-SP
6"	5.51	4	SS-600-SP



STRAINER TOP HOLE

Size	Weight (lbs)	Std Pack Qty	Part #
1-1/2"	1.65	50	ST-150-SP
2"	1.98	50	ST-200-SP
3"	2.64	50	ST-300-SP



Air and
General
Purpose
Hose

STRAINER BOTTOM HOLE

Water
Suction
and
Discharge
Hose

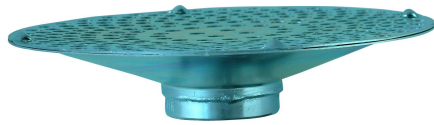

Size	Weight (lbs)	Std Pack Qty	Part #
1-1/2"	1.65	20	SB-150-SP
2"	1.98	20	SB-200-SP
3"	2.64	15	SB-300-SP

Petroleum,
Steam and
Chemical
Hose

STRAINER ROUND HOLE LONG THIN

Rubber
Material
Handling
Hose

Size	Weight (lbs)	Std Pack Qty	Part #
1-1/2"	2.50	20	SL-150-SP
2"	3.00	15	SL-200-SP
3"	3.60	10	SL-300-SP



Plastic
Material
Handling
Hose

Food Hose

Ducting

Auto
Truck and
Marine
Hose

Fire Hose

Welding
and
Other Hose

Cam
and
Groove

Nipples
Menders
and
Shank
Fittings

Clamps

High
Pressure
Fittings

Mine
Fittings

Air
Fittings

Valves

Sandblast

Fire
Fittings

Pipe
Fittings

Sheet
Rubber

Index
and
Technical
Information

FOOT VALVE



Description	Weight (lbs)	Std Pack Qty	Part #
3/4" FOOT VALVE	0.79	10	FV-075-DP
1" FOOT VALVE	0.97	10	FV-100-DP
2" FOOT VALVE	4.68	8	FV-200-DP
2-1/2" FOOT VALVE	6.23	6	FV-250-DP
3" FOOT VALVE	8.36	5	FV-300-DP
4" FOOT VALVE	16.52	2	FV-400-DP
6" FOOT VALVE	44.00	1	FV-600-DP
8" FOOT VALVE	88.00	1	FV-800-DP

STRAINER FOR FOOT VALVE

Description	Weight (lbs)	Std Pack Qty	Part #
1-1/2"STRAINER FOR FOOT VALVE	0.77	40	FVS-150-DP
2" STRAINER FOR FOOT VALVE	1.17	30	FVS-200-DP
2-1/2"STRAINER FOR FOOT VALVE	1.76	20	FVS-250-DP
3" STRAINER FOR FOOT VALVE	2.09	20	FVS-300-DP
4"STRAINER FOR FOOT VALVE	3.52	10	FVS-400-DP
6"STRAINER FOR FOOT VALVE	11.01	4	FVS-600-DP
8"STRAINER FOR FOOT VALVE	22.03	2	FVS-800-DP



SEAT PLATE FOR FOOT VALVE



Description	Weight (lbs)	Std Pack Qty	Part #
SEAT PLATE FOR 1-1/2" FOOT VALVE	0.33	40	FVP-150-DP
SEAT PLATE FOR 2" FOOT VALVE	0.44	30	FVP-200-DP
SEAT PLATE FOR 2-1/2" FOOT VALVE	0.77	30	FVP-250-DP
SEAT PLATE FOR 3" FOOT VALVE	0.81	20	FVP-300-DP
SEAT PLATE FOR 4" FOOT VALVE	2.20	10	FVP-400-DP
SEAT PLATE FOR 6" FOOT VALVE	5.73	5	FVP-600-DP
SEAT PLATE FOR 8" FOOT VALVE	13.22	2	FVP-800-DP

Air and General Purpose Hose

FLAPPER FOR FOOT VALVE

Water Suction and Discharge Hose

Petroleum, Steam and Chemical Hose

Rubber Material Handling Hose

Plastic Material Handling Hose

Food Hose

Ducting

Auto Truck and Marine Hose

Fire Hose

Welding and Other Hose

Cam and Groove

Nipples, Menders and Shank Fittings

Clamps

High Pressure Fittings

Mine Fittings

Air Fittings

Valves

Sandblast

Fire Fittings

Pipe Fittings

Sheet Rubber

Index and Technical Information

Description	Weight (lbs)	Std Pack Qty	Part #
FLAPPER FOR 1-1/2" FOOT VALVE	0.26	60	FVF-150-DP
FLAPPER FOR 2" FOOT VALVE	0.40	50	FVF-200-DP
FLAPPER FOR 2-1/2" FOOT VALVE	0.95	30	FVF-250-DP
FLAPPER FOR 3" FOOT VALVE	1.10	25	FVF-300-DP
FLAPPER FOR 4" FOOT VALVE	2.64	15	FVF-400-DP
FLAPPER FOR 6" FOOT VALVE	5.29	12	FVF-600-DP
FLAPPER FOR 8" FOOT VALVE	10.28	3	FVF-800-DP



FOOT VALVE LEATHER

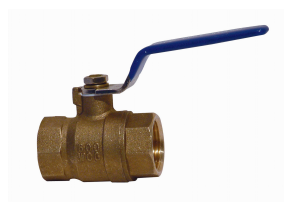

Description	Weight (lbs)	Std Pack Qty	Part #
1-1/2" FOOT VALVE LEATHER	0.04	100	FVG-150-L
2" FOOT VALVE LEATHER	0.06	100	FVG-200-L
2-1/2" FOOT VALVE LEATHER	0.09	100	FVG-250-L
3" FOOT VALVE LEATHER	0.11	100	FVG-300-L
4" FOOT VALVE LEATHER	0.31	100	FVG-400-L
6" FOOT VALVE LEATHER	0.55	50	FVG-600-L
8" FOOT VALVE LEATHER	1.10	50	FVG-800-L

BALL VALVE FULL PORT BRASS NPT**Application** : FULL PORT 600 W.O.G. (COLD WATER,OIL,GAS)

Size	Std Pack Qty	Weight (lbs)	Part #
1/4"	40	0.20	BV-025-B1
3/8"	40	0.28	BV-038-B1
1/2"	40	0.45	BV-050-B1
3/4"	40	0.70	BV-075-B1
1"	40	1.13	BV-100-B1
1-1/4"	40	1.70	BV-125-B1
1-1/2"	40	2.40	BV-150-B1
2"	40	3.30	BV-200-B1
2-1/2"	40	7.00	BV-250-B1
3"	40	9.49	BV-300-B1
4"	40	16.97	BV-400-B1

BALL VALVE FULL PORT STAINLESS NPT**Application** : FULL PORT 2 PIECE 1000 W.O.G. (COLD WATER,OIL,GAS)

Size	Std Pack Qty	Weight (lbs)	Part #
1/4"	40	0.46	BV-025-SS
3/8"	40	0.48	BV-038-SS
1/2"	40	0.63	BV-050-SS
3/4"	40	0.93	BV-075-SS
1"	40	1.56	BV-100-SS
1-1/4"	40	2.33	BV-125-SS
1-1/2"	40	2.38	BV-150-SS
2"	40	5.97	BV-200-SS

POLYPROPYLENE BOLTED BALL VALVE ECONO TYPE



BBV

BBVM

BBVMA

BBVA

Fastener Material : Stainless Steel Nuts and Bolts
Stem O Ring : Viton
Stem Seal : PTFE (Teflon)
Ball Seat : PTFE (Teflon)
Body Seal : PTFE (Teflon)

Thread Size	Port Size	Port	# of Bolts	Max PSI(70F)	Part #
2"	2"	Full	4	125	BBV-E200FP-PP
2"	1-1/2"	Standard	4	125	BBV-E2015-PP
2"	2"	Full	4	125	BBVA-E200FP-PP
2"	2"	Full	4	125	BBVM-E200FP-PP
2"	2"	Full	4	125	BBVMA-E200FP-PP

POLYPROPYLENE BOLTED BALL VALVE CAMLOCK TYPE



BBVD

BBVMD

BBVAD

BBVMM

Fastener Material : Stainless Steel Nuts and Bolts
Stem O Ring : Viton
Stem Seal : PTFE (Teflon)
Ball Seat : PTFE (Teflon)
Body Seal : PTFE (Teflon)

Thread Size	Port Size	Port	# of Bolts	Max PSI(70F)	Part #
2"	2"	Full	4	125	BBVAD-E200FP-PP
2"	2"	Full	4	125	BBVD-E200FP-PP
2"	2"	Full	4	125	BBVMD-E200FP-PP
2"	2"	Full	4	125	BBVMM-E200FP-PP

POLYPROPYLENE BOLTED BALL VALVE



4 BOLT



6 BOLT

Fastener Material : Stainless Steel Nuts and Bolts
Stem O Ring : Viton
Stem Seal : PTFE (Teflon)
Ball Seat : PTFE (Teflon)
Body Seal : PTFE (Teflon)

Thread Size	Port Size	Port	# of Bolts	Max PSI(70F)	Part #
1/2"	3/4"	Full	4	150	BBV-0508FP-PP
3/4"	3/4"	Full	4	150	BBV-075FP-PP
1"	3/4"	Standard	4	150	BBV-1008-PP
1"	1"	Full	4	150	BBV-100FP-PP
1-1/4"	1"	Standard	4	150	BBV-1210-PP
1-1/4"	1-1/2"	Full	4	150	BBV-1215FP-PP
1-1/2"	1-1/2"	Full	4	150	BBV-150FP-PP
2"	2"	Full	6	150	BBV-200FP-PP
2"	1-1/2"	Standard	4	150	BBV-2015-PP
3"	3"	Full	6	100	BBV-300FP-PP
3"	2-1/2"	Standard	6	100	BBV-3025-PP
4"	4"	Full	6	75	BBV-400FP-PP
4"	3-1/2"	Standard	6	75	BBV-4035-PP

Air and General Purpose Hose

Water Suction and Discharge Hose

Petroleum, Steam and Chemical Hose

Rubber Material Handling Hose

Plastic Material Handling Hose

Food Hose

Ducting

Auto Truck and Marine Hose

Fire Hose

Welding and Other Hose

Cam and Groove

Nipples Menders and Shank Fittings

Clamps

High Pressure Fittings

Mine Fittings

Air Fittings

Valves

Sandblast

Fire Fittings

Pipe Fittings

Sheet Rubber

Index and Technical Information

POLYPROPYLENE BOLTED BALL VALVE WITH NOZZLE

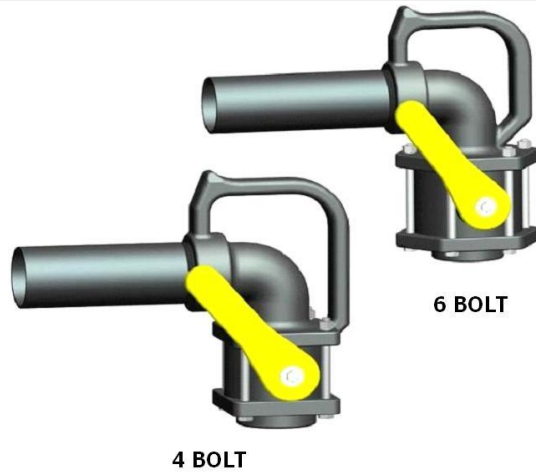

Fastener Material : Stainless Steel Nuts and Bolts
Stem O Ring : Viton
Stem Seal : PTFE (Teflon)
Ball Seat : PTFE (Teflon)
Body Seal : PTFE (Teflon)

	Thread Size	Port Size	Port	# of Bolts	Max PSI(70F)	Part #
Welding and Other Hose	1-1/2"	1-1/2"	Full	4	150	BBVN-150FP-PP
	2"	1-1/2"	Standard	4	150	BBVN-200-PP
Cam and Groove	2"	2"	Full	6	150	BBVN-200FP-PP
	3"	3"	Full	6	100	BBVN-300FP-PP

Air and General Purpose Hose

Water Suction and Discharge Hose

Petroleum, Steam and Chemical Hose

Rubber Material Handling Hose

Plastic Material Handling Hose

Food Hose

Ducting

Auto Truck and Marine Hose

Fire Hose

Welding and Other Hose

Cam and Groove

Nipples, Menders and Shank Fittings

Clamps

High Pressure Fittings

Mine Fittings

Air Fittings

Valves

Sandblast

Fire Fittings

Pipe Fittings

Sheet Rubber

Index and Technical Information

SANDBLAST COUPLING ALUMINUM



Description	Weight (lbs)	Part #
3/4" Q1 SANDBLAST COUPLING ALUM	0.40	SQC-075-A
1" Q2 SANDBLAST COUPLING ALUM	0.44	SQC-100-A
1-1/4" Q3 SANDBLAST CPLG ALUM	0.79	SQC-125-A
1-1/2" Q4 SANDBLAST CPLG ALUM	0.88	SQC-150-A
1-1/2" Q5 FULL PORT ALUM SANDBLAST CPLG	1.10	SQC-151-A
2" Q6 ALUM SANDBLAST COUPLING	1.90	SQC-200-A

Safety Information : Sandblast couplings are to be attached with the screws supplied with the couplings.

SANDBLAST COUPLING BRASS

Description	Weight (lbs)	Part #
3/4" Q1 SANDBLAST CPLG BRASS	1.10	SQC-075-B
1" Q2 SANDBLAST CPLG BRASS	1.10	SQC-100-B
1-1/4" Q3 SANDBLAST CPLG BRASS	2.03	SQC-125-B
1-1/2" Q4 SANDBLAST CPLG BRASS	2.53	SQC-150-B



Safety Information : Sandblast couplings are to be attached with the screws supplied with the couplings.

SANDBLAST COUPLING NYLON



Description	Weight (lbs)	Part #
3/4" Q1 NYLON SANDBLAST COUPLING	0.40	SQC-075-NY
1" Q2 NYLON SANDBLAST COUPLING	0.51	SQC-100-NY
1-1/4" Q3 NYLON SANDBLAST COUPLING	0.59	SQC-125-NY
1-1/2" Q4 NYLON SANDBLAST COUPLING	0.70	SQC-150-NY

Safety Information : Sandblast couplings are to be attached with the screws supplied with the couplings.

- Air and General Purpose Hose
- Water Suction and Discharge Hose
- Petroleum, Steam and Chemical Hose
- Rubber Material Handling Hose
- Plastic Material Handling Hose
- Food Hose
- Ducting
- Auto Truck and Marine Hose
- Fire Hose
- Welding and Other Hose
- Cam and Groove
- Nipples, Menders and Shank Fittings
- Clamps
- High Pressure Fittings
- Mine Fittings
- Air Fittings
- Valves
- Sandblast
- Fire Fittings
- Pipe Fittings
- Sheet Rubber
- Index and Technical Information

Air and General Purpose Hose

NOZZLE HOLDER ALUMINUM FEMALE NPT

Description	Weight (lbs)	Part #
3/4" HE1 NOZZLE HOLDER ALUM	0.31	SNH-075-A
1" HE2 NOZZLE HOLDER ALUM	0.37	SNH-100-A
1-1/4" HE3 NOZZLE HOLDER ALUM	0.55	SNH-125-A
1-1/2" HE4 NOZZLE HOLDER ALUM	0.83	SNH-150-A



Product Information : All Sandblast Nozzles feature 1-1/4" female NPT

Safety Information : Sandblast couplings are to be attached with the screws supplied with the couplings.

Water Suction and Discharge Hose

Petroleum, Steam and Chemical Hose

Rubber Material Handling Hose

Plastic Material Handling Hose

NOZZLE HOLDER BRASS FEMALE NPT



Description	Weight (lbs)	Part #
3/4" HE1 NOZZLE HOLDER BRASS	0.93	SNH-075-B
1" HE2 NOZZLE HOLDER BRASS	1.01	SNH-100-B
1-1/4" HE3 NOZZLE HOLDER BRASS	1.70	SNH-125-B
1-1/2" HE4 NOZZLE HOLDER BRASS	3.04	SNH-150-B

Product Information : All Sandblast Nozzles feature 1-1/4" female NPT

Safety Information : Sandblast couplings are to be attached with the screws supplied with the couplings.

Food Hose

Ducting

Auto Truck and Marine Hose

Fire Hose

Welding and Other Hose

Cam and Groove

NOZZLE HOLDER NYLON FEMALE NPT

Description	Weight (lbs)	Part #
3/4" HE1 NYLON NOZZLE HOLDER	0.26	SNH-075-NY
1" HE2 NYLON NOZZLE HOLDER	0.35	SNH-100-NY
1-1/4" HE3 NYLON NOZZLE HOLDER	0.44	SNH-125-NY
1-1/2" HE4 NYLON NOZZLE HOLDER	0.48	SNH-150-NY



Product Information : All Sandblast Nozzles feature 1-1/4" female NPT

Safety Information : Sandblast couplings are to be attached with the screws supplied with the couplings.

Nipples Menders and Shank Fittings

Clamps

High Pressure Fittings

Mine Fittings

Air Fittings

Valves

THREADED ADAPTER ALUMINUM FEMALE NPT



Description	Weight (lbs)	Part #
1-1/4" THREADED ADAPTER ALUM	0.23	STA-125-A
1-1/2" THREADED ADAPTER ALUM	0.29	STA-150-A
1-1/2" FULL PORT TANK ADAPTER	0.29	STA-151-A

Safety Information : Sandblast couplings are to be attached with the screws supplied with the couplings.

Sandblast

Fire Fittings

Pipe Fittings

Sheet Rubber

Index and Technical Information

THREADED ADAPTER BRASS FEMALE NPT

Description	Weight (lbs)	Part #
1-1/4"THREADED ADAPTER BRASS	1.04	STA-125-B
1-1/2"THREADED ADAPTER BRASS	0.73	STA-150-B



Safety Information : Sandblast couplings are to be attached with the screws supplied with the couplings.

THREADED ADAPTER NYLON FEMLAE NPT



Description	Weight (lbs)	Part #
1-1/4"NYLON THREADED ADAPTER	0.26	STA-125-NY
1-1/2"NYLON THREADED ADAPTER	0.26	STA-150-NY

Safety Information : Sandblast couplings are to be attached with the screws supplied with the couplings.

THREADED ADAPTER ALUMINUM FEMALE NPS

Description	Weight (lbs)	Part #
1-1/4"NPS THREADED ADAPTER ALUM	0.23	STA-125-ANPS
1-1/2"NPS THREADED ADAPTER ALUM	0.26	STA-150-ANPS



Safety Information : Sandblast couplings are to be attached with the screws supplied with the couplings.

THREADED ADAPTER BRASS FEMALE NPS



Description	Weight (lbs)	Part #
1-1/4"NPS THREADED ADAPTER BRASS	1.04	STA-125-BNPS
1-1/2"NPS THREADED ADAPTER BRASS	0.77	STA-150-BNPS

Safety Information : Sandblast couplings are to be attached with the screws supplied with the couplings.

Air and General Purpose Hose

Water Suction and Discharge Hose

Petroleum, Steam and Chemical Hose

Rubber Material Handling Hose

Plastic Material Handling Hose

Food Hose

Ducting

Auto Truck and Marine Hose

Fire Hose

Welding and Other Hose

Cam and Groove

Nipples Menders and Shank Fittings

Clamps

High Pressure Fittings

Mine Fittings

Air Fittings

Valves

Sandblast

Fire Fittings

Pipe Fittings

Sheet Rubber

Index and Technical Information

Air and General Purpose Hose

SANDBLAST GASKET

Water Suction and Discharge Hose

Description	Weight (lbs)	Part #
SANDBLAST GASKET	0.06	SRG
SANDBLAST GASKET SQC-075-NY ONLY	0.04	SRG-NY1
SANDBLAST GASKET FOR NYLON CPLGS	0.04	SRG-NY2

Petroleum, Steam and Chemical Hose

SANDBLAST GASKET FULL PORT

Rubber Material Handling Hose

Description	Weight (lbs)	Part #
2" FULL PORT SANDBLAST GASKET	0.06	SRG-2

Plastic Material Handling Hose

Food Hose

Ducting

Auto Truck and Marine Hose

Fire Hose

Welding and Other Hose

Cam and Groove

Nipples Menders and Shank Fittings

Clamps

High Pressure Fittings

Mine Fittings

Air Fittings

Valves

Sandblast

Fire Fittings

Pipe Fittings

Sheet Rubber

Index and Technical Information

FORESTRY FITTING



Size	Description	Weight (lbs)	Part #
1-1/2"	FORESTRY FITTING DUST CAP	0.10	FCDC-150-A
1-1/2"	FORESTRY FITTING EXPANSION RING	0.08	FCER-150-A
1-1/2"	FORESTRY FITTING FEMALE NPT	0.22	FCF-150-A
1-1/2"	FORESTRY FITTING FEMALE NPS W GASKET	0.22	FCFTG-150-A-NPS
1-1/2"	FORESTRY FITTING HOSE END	0.22	FCH-150-A
1-1/2"	FORESTRY FITTING FACE GASKET	0.05	FCHG-150-NBR
1-1/2"	FORESTRY FITTING MALE NPT	0.22	FCM-150-A
1-1/2"	FORESTRY FITTING TAIL GASKET	0.01	FCTG-150-NBR

PYROLITE SET NPS

Size	Bowl Size	Weight (lbs)	Std Pack Qty	Part #
1-1/2"	1-11/16"	0.81	25	FCP-150-11
1-1/2"	1-3/4"	0.59	25	FCP-150-12
1-1/2"	1-13/16"	0.67	25	FCP-150-13
1-1/2"	1-15/16"	0.75	25	FCP-150-15
1-3/4"	2"	0.95	25	FCP-175-0
1-3/4"	2-1/16"	1.05	25	FCP-175-1
2"	2-1/4"	1.08	25	FCP-200-4
2"	2-3/8"	1.17	25	FCP-200-6
2"	2-1/2"	1.25	25	FCP-200-8



PYROLITE SET CSA

Size	Bowl Size	Weight (lbs)	Std Pack Qty	Part #
2-1/2"	2-11/16"	1.55	25	FCP-250-11
2-1/2"	2-3/4"	1.61	25	FCP-250-12
2-1/2"	2-3/16"	1.59	25	FCP-250-13
2-1/2"	3"	2.05	25	FCP-250-16



Air and
General
Purpose
Hose

STORZ CLAMPS

Water
Suction
and
Discharge
Hose



Petroleum,
Steam and
Chemical
Hose

Rubber
Material
Handling
Hose

Plastic
Material
Handling
Hose

Food Hose

Ducting

Auto
Truck and
Marine
Hose

Fire Hose

Welding
and
Other Hose

Cam
and
Groove

Nipples
Menders
and
Shank
Fittings

Clamps

High
Pressure
Fittings

Mine
Fittings

Air
Fittings

Valves

Sandblast

Fire
Fittings

Pipe
Fittings

Sheet
Rubber

Index
and
Technical
Information

Description	Weight (lbs)	Part #
4" CLAMPS FOR STORZ	1.21	CRS-400
5" CLAMPS FOR STORZ	1.60	CRS-500

BRASS SET NPSH



Size	Bowl Size	Weight (lbs)	Std Pack Qty	Part #
1-1/2"	1-11/16"	2.38	25	FCB-150-11
1-1/2"	1-3/4"	2.38	25	FCB-150-12
1-1/2"	1-13/16"	2.38	25	FCB-150-13
1-1/2"	1-15/16"	2.38	25	FCB-150-15
2"	2-3/16"	2.58	25	FCB-200-3
2"	2-5/16"	2.58	25	FCB-200-5
2"	2-3/8"	2.58	25	FCB-200-6

BRASS SET CSA

Size	Bowl Size	Weight (lbs)	Std Pack Qty	Part #
2-1/2"	2-11/16"	2.85	25	FCB-250-11
2-1/2"	2-3/4"	2.85	25	FCB-250-12
2-1/2"	2-13/16"	2.85	25	FCB-250-13
2-1/2"	2-7/8"	2.85	25	FCB-250-14
2-1/2"	3"	2.85	25	FCB-250-16



- Air and General Purpose Hose
- Water Suction and Discharge Hose
- Petroleum, Steam and Chemical Hose
- Rubber Material Handling Hose
- Plastic Material Handling Hose
- Food Hose
- Ducting
- Auto Truck and Marine Hose
- Fire Hose
- Welding and Other Hose
- Cam and Groove
- Nipples Menders and Shank Fittings
- Clamps
- High Pressure Fittings
- Mine Fittings
- Air Fittings
- Valves
- Sandblast
- Fire Fittings
- Pipe Fittings
- Sheet Rubber
- Index and Technical Information

Safety Information : Black Iron fittings are NPS thread and recommended for use with liquids only

CLOSE NIPPLE BLACK



Description	Weight (lbs)	Std Pack Qty	Part #
1/4" CLOSE NIPPLE BLACK	0.02	25	PCN-025-S
3/8" CLOSE NIPPLE BLACK	0.04	25	PCN-038-S
1/2" CLOSE NIPPLE BLACK	0.08	25	PCN-050-S
3/4" CLOSE NIPPLE BLACK	0.11	25	PCN-075-S
1" CLOSE NIPPLE BLACK	0.13	25	PCN-100-S
1-1/4" CLOSE NIPPLE BLACK	0.20	25	PCN-125-S
1-1/2" CLOSE NIPPLE BLACK	0.26	25	PCN-150-S
2" CLOSE NIPPLE BLACK	0.46	25	PCN-200-S
2-1/2" CLOSE NIPPLE BLACK	0.77	25	PCN-250-S
3" CLOSE NIPPLE BLACK	1.04	25	PCN-300-S
4" CLOSE NIPPLE BLACK	1.76	25	PCN-400-S

REDUCING BUSHING BLACK



Description	Weight (lbs)	Std Pack Qty	Part #
3/8"X1/4" REDUCING BUSHING BLACK	0.04	25	PRB-038-025-S
1/2"X1/4" REDUCING BUSHING BLACK	0.09	25	PRB-050-025-S
1/2"X3/8" REDUCING BUSHING BLACK	0.09	25	PRB-050-038-S
3/4"X1/4" REDUCING BUSHING BLACK	0.15	25	PRB-075-025-S
3/4"X3/8" REDUCING BUSHING BLACK	0.15	25	PRB-075-038-S
3/4"X1/2" REDUCING BUSHING BLACK	0.15	25	PRB-075-050-S
1"X3/8" REDUCING BUSHING BLACK	0.22	25	PRB-100-038-S
1"X1/2" REDUCING BUSHING BLACK	0.24	25	PRB-100-050-S
1"X3/4" REDUCING BUSHING BLACK	0.24	25	PRB-100-075-S
1-1/4"X1" REDUCING BUSHING BLACK	0.35	25	PRB-125-100-S
1-1/2"X1" REDUCING BUSHING BLACK	0.46	25	PRB-150-100-S
1-1/2"X1-1/4" REDUCING BUSHING BLACK	0.35	25	PRB-150-125-S
2"X1" REDUCING BUSHING BLACK	0.99	25	PRB-200-100-S
2"X1-1/2" REDUCING BUSHING BLACK	0.68	25	PRB-200-150-S
2-1/2"X1" REDUCING BUSHING BLACK	0.90	25	PRB-250-100-S
2-1/2"X2" REDUCING BUSHING BLACK	0.99	25	PRB-250-200-S
3"X2" REDUCING BUSHING BLACK	2.14	25	PRB-300-200-S
3"X2-1/2" REDUCING BUSHING BLACK	1.92	25	PRB-300-250-S
4"X3" REDUCING BUSHING BLACK	3.15	25	PRB-400-300-S

Air and General Purpose Hose
 Water Suction and Discharge Hose
 Petroleum, Steam and Chemical Hose
 Rubber Material Handling Hose
 Plastic Material Handling Hose
 Food Hose
 Ducting
 Auto Truck and Marine Hose
 Fire Hose
 Welding and Other Hose
 Cam and Groove
 Nipples Menders and Shank Fittings
 Clamps
 High Pressure Fittings
 Mine Fittings
 Air Fittings
 Valves
 Sandblast
 Fire Fittings
 Pipe Fittings
 Sheet Rubber
 Index and Technical Information

Air and General Purpose Hose

REDUCING COUPLING BLACK

Water Suction and Discharge Hose

Petroleum, Steam and Chemical Hose

Rubber Material Handling Hose

Plastic Material Handling Hose



Food Hose

Ducting

Auto Truck and Marine Hose

Fire Hose

Welding and Other Hose

Cam and Groove

Nipples, Menders and Shank Fittings

Clamps

High Pressure Fittings

Mine Fittings

Air Fittings

Valves



Sandblast

Fire Fittings

Pipe Fittings

Sheet Rubber

Index and Technical Information

Description	Weight (lbs)	Std Pack Qty	Part #
3/8"X1/4" REDUCING COUPLING BLACK	0.11	25	PRC-038-025-S
1/2"X1/4" REDUCING COUPLING BLACK	0.15	25	PRC-050-025-S
1/2"X3/8" REDUCING COUPLING BLACK	0.18	25	PRC-050-038-S
3/4"X1/4" REDUCING COUPLING BLACK	0.22	25	PRC-075-025-S
3/4"X3/8" REDUCING COUPLING BLACK	0.26	25	PRC-075-038-S
3/4"X1/2" REDUCING COUPLING BLACK	0.33	25	PRC-075-050-S
1"X3/8" REDUCING COUPLING BLACK	0.37	25	PRC-100-038-S
1"X1/2" REDUCING COUPLING BLACK	0.40	25	PRC-100-050-S
1"X3/4" REDUCING COUPLING BLACK	0.42	25	PRC-100-075-S
1-1/4"X1" REDUCING COUPLING BLACK	0.66	25	PRC-125-100-S
1-1/2"X1" REDUCING COUPLING BLACK	0.81	25	PRC-150-100-S
1-1/2"X1-1/4" REDUCING COUPLING BLACK	0.88	25	PRC-150-125-S
2"X1" REDUCING COUPLING BLACK	1.15	25	PRC-200-100-S
2"X1-1/2" REDUCING COUPLING BLACK	1.41	25	PRC-200-150-S
2-1/2"X1" REDUCING COUPLING BLACK	1.98	25	PRC-250-100-S
2-1/2"X2" REDUCING COUPLING BLACK	2.27	25	PRC-250-200-S
3"X2" REDUCING COUPLING BLACK	3.41	25	PRC-300-200-S
3"X2-1/2" REDUCING COUPLING BLACK	3.52	25	PRC-300-250-S
4"X3" REDUCING COUPLING BLACK	6.00	25	PRC-400-300-S

STRAIGHT COUPLING BLACK

Size	Weight (lbs)	Std Pack Qty	Part #
1/4"	0.09	25	PSC-025-S
3/8"	0.13	25	PSC-038-S
1/2"	0.20	25	PSC-050-S
3/4"	0.31	25	PSC-075-S
1"	0.44	25	PSC-100-S
1-1/4"	0.68	25	PSC-125-S
1-1/2"	0.84	25	PSC-150-S
2"	1.43	25	PSC-200-S
2-1/2"	2.47	25	PSC-250-S
3"	3.48	25	PSC-300-S
4"	5.50	25	PSC-400-S

BUTYL

REGULAR BUTYL

General Characteristics : Excellent ozone and weather resistance. Very Good resistance to heat and has a low gas permeation rate
Durometer Shore A : 60
Colour : BLACK
Elongation % : 350
Tensile PSI : 1250
Temperature : 0C to +110C(32F to +230F)

Thickness	Width	Roll Length	Weight (lbs)	Part #
1/16"	48"	100	0.45	BU60-006-48
1/8"	48"	66'	0.90	BU60-013-48
1/4"	48"	50'	1.80	BU60-025-48

Cut Charge : Plus 15%, Cut strips will be priced on a per item basis. Please call for pricing.

HYPALON

REGULAR HYPALON

General Characteristics : Good flame and acid resistance. Low resistance to oil and solvents
Durometer Shore A : 60
Colour : BLACK
Elongation % : 300
Tensile PSI : 1200
Temperature : -29C to +121C(-20F to +250F)

Thickness	Width	Roll Length	Weight (lbs)	Part #
1/16"	48"	100'	0.48	HY60-006-48
1/8"	48"	66'	0.96	HY60-013-48
3/16"	48"	66'	1.44	HY60-019-48
1/4"	48"	50'	1.92	HY60-025-48

Cut Charge : Plus 15%, Cut strips will be priced on a per item basis. Please call for pricing.

Air and General Purpose Hose

Water Suction and Discharge Hose

Petroleum, Steam and Chemical Hose

Rubber Material Handling Hose

Plastic Material Handling Hose

Food Hose

Ducting

Auto Truck and Marine Hose

Fire Hose

Welding and Other Hose

Cam and Groove

Nipples Menders and Shank Fittings

Clamps

High Pressure Fittings

Mine Fittings

Air Fittings

Valves

Sandblast

Fire Fittings

Pipe Fittings

Sheet Rubber

Index and Technical Information

REGULAR EPDM

General Characteristics : Excellent ozone and weather resistance. Very Good resistance to heat and has a low gas permeation rate
Durometer Shore A : 60
Colour : BLACK
Elongation % : 260
Tensile PSI : 500
Temperature : -25C to +110C(-13F to +230F)

	Thickness	Width	Roll Length	Weight (lbs)	Part #
	1/16"	36"	100'	0.48	EP60-006-36
	1/16"	48"	100'	0.48	EP60-006-48
	1/8"	36"	50'	0.96	EP60-013-36
	1/8"	48"	66'	0.96	EP60-013-48
	3/16"	36"	50'	1.44	EP60-019-36
	3/16"	48"	66'	1.44	EP60-019-48
	1/4"	36"	50'	1.92	EP60-025-36
	1/4"	48"	50'	1.92	EP60-025-48
	3/8"	48"	50'	2.88	EP60-038-48
	1/2"	48"	50'	3.84	EP60-050-48

Cut Charge : Plus 15%, Cut strips will be priced on a per item basis. Please call for pricing.

- Air and General Purpose Hose
- Water Suction and Discharge Hose
- Petroleum, Steam and Chemical Hose
- Rubber Material Handling Hose
- Plastic Material Handling Hose
- Food Hose
- Ducting
- Auto Truck and Marine Hose
- Fire Hose
- Welding and Other Hose
- Cam and Groove
- Nipples Menders and Shank Fittings
- Clamps
- High Pressure Fittings
- Mine Fittings
- Air Fittings
- Valves
- Sandblast
- Fire Fittings
- Pipe Fittings
- Sheet Rubber
- Index and Technical Information

REGULAR NEOPRENE

General : Good resistance to heat, oils, some chemicals and solvents

Characteristics

Durometer Shore A : 50/60/70/80

Colour : BLACK

Elongation % : 250

Tensile PSI : 500

Temperature : -25C to +85C(-13F to +185F)

Thickness	Width	Roll Length	Weight (lbs)	Part #
1/32"	36"	100'	0.22	NEO60-003-36
1/32"	48"	100'	0.22	NEO60-003-48
1/16"	36"	50'	0.48	NEO60-006-36
1/16"	48"	50'	0.48	NEO60-006-48
3/32"	36"	50'	0.73	NEO60-010-36
3/32"	48"	66'	0.73	NEO60-010-48
1/8"	36"	50'	0.98	NEO60-013-36
1/8"	48"	66'	0.98	NEO60-013-48
3/16"	36"	50'	1.47	NEO60-019-36
3/16"	48"	66'	1.47	NEO60-019-48
1/4"	36"	50'	1.93	NEO60-025-36
1/4"	48"	50'	1.93	NEO60-025-48
3/8"	36"	50'	2.94	NEO60-038-36
3/8"	48"	50'	2.94	NEO60-038-48
1/2"	48"	50'	3.84	NEO60-050-48
3/4"	36"	50'	5.79	NEO60-075-36
3/4"	48"	50'	5.79	NEO60-075-48
1"	48"	50'	7.68	NEO60-100-48
1-1/2"	36"	9'	10.55	NEO60-150-36
1-1/2"	48"	9'	11.52	NEO60-150-48
2"	48"	9'	15.36	NEO60-200-48

Cut Charge : Plus 15%, Cut strips will be priced on a per item basis. Please call for pricing.

Air and
General
Purpose
HoseWater
Suction
and
Discharge
HosePetroleum,
Steam and
Chemical
HoseRubber
Material
Handling
HosePlastic
Material
Handling
Hose

Food Hose

Ducting

Auto
Truck and
Marine
Hose

Fire Hose

Welding
and
Other HoseCam
and
GrooveNipples
Menders
and
Shank
Fittings

Clamps

High
Pressure
FittingsMine
FittingsAir
Fittings

Valves

Sandblast

Fire
FittingsPipe
FittingsSheet
RubberIndex
and
Technical
Information

WHITE NITRILE

General : Good oil resistance. Food quality
Characteristics
Durometer Shore A : 60
Colour : WHITE
Elongation % : 600
Tensile PSI : 1200
Temperature : -30C to +100C(-22F to +212F)

Table with 6 columns: Thickness, Width, Roll Length, Weight (lbs), Part #. Rows include various hose types like Plastic Material Handling, Food Hose, Ducting, Auto Truck and Marine, and Fire Hose.

NITRILE

REGULAR NITRILE

General : Very good oil resistance
Characteristics
Durometer Shore A : 60/70
Colour : BLACK
Elongation % : 250
Tensile PSI : 500
Temperature : -20C to +80C(-4F to +175F)

Table with 6 columns: Thickness, Width, Roll Length, Weight (lbs), Part #. Rows include various fittings and hose types like High Pressure Fittings, Mine Fittings, Air Fittings, Valves, Sandblast, Fire Fittings, Pipe Fittings, and Sheet Rubber.

Cut Charge : Plus 15%, Cut strips will be priced on a per item basis. Please call for pricing.

PURE GUM

Temperature : -34C to +65C(-30F to +150F)
Tensile PSI : 2500
General Characteristics : Excellent cut and abrasion resistance. Very resilient
Durometer Shore A : 40
Elongation % : 600
Colour : TAN

Thickness	Width	Roll Length	Weight (lbs)	Part #
1/16"	48"	100'	0.33	PG40P-006-48
1/8"	48"	66'	0.66	PG40P-013-48
3/16"	48"	66'	0.99	PG40P-019-48
1/4"	48"	50'	1.32	PG40P-025-48
3/8"	48"	50'	1.98	PG40P-038-48
1/2"	48"	50'	2.64	PG40P-050-48
3/4"	48"	50'	3.96	PG40P-075-48
1"	48"	50'	5.28	PG40P-100-48

Cut Charge : Plus 15%, Cut strips will be priced on a per item basis. Please call for pricing.

CHUTE AND LAUNDER - 1 OUTER FABRIC PLY

CHUTE AND LAUNDER - 1 OUTER PLY FABRIC

Durometer Shore A : 55
Colour : BLACK
Elongation % : 250
Tensile PSI : 500
Temperature : -20C to +75C(-4F to +170F)

Thickness	Width	Roll Length	Weight (lbs)	Part #
1/4"	48"	50'	2.00	CH-025-48
3/8"	48"	50'	3.00	CH-038-48
1/2"	48"	50'	4.00	CH-050-48
3/4"	48"	50'	6.00	CH-075-48
1"	48"	50'	8.00	CH-100-48

- Air and General Purpose Hose
- Water Suction and Discharge Hose
- Petroleum, Steam and Chemical Hose
- Rubber Material Handling Hose
- Plastic Material Handling Hose
- Food Hose
- Ducting
- Auto Truck and Marine Hose
- Fire Hose
- Welding and Other Hose
- Cam and Groove
- Nipples Menders and Shank Fittings
- Clamps
- High Pressure Fittings
- Mine Fittings
- Air Fittings
- Valves
- Sandblast
- Fire Fittings
- Pipe Fittings
- Sheet Rubber
- Index and Technical Information

REGULAR NEOPRENE DIAPHRAGM SHEET

General Characteristics : Good resistance to heat, oils, some chemicals and solvents with better tear resistance than all rubber neoprene

Durometer Shore A : 60

Colour : BLACK

Elongation % : 250

Tensile PSI : 500

Temperature : -25C to +85C(-13F to +185F)

	Thickness	Width	Roll Length	Weight (lbs)	Part #
	1/16"	36"	100'	0.46	DIA-006-36-1
	1/16"	48"	50'	0.46	DIA-006-48-1
	3/32"	36"	50'	0.70	DIA-010-36-1
	3/32"	48"	66'	0.70	DIA-010-48-1
	1/8"	36"	50'	0.94	DIA-013-36-1
	1/8"	48"	66'	0.94	DIA-013-48-1
	1/8"	36"	50'	0.96	DIA-013-36-2
	1/8"	48"	66'	0.96	DIA-013-48-2
	3/16"	36"	50'	1.40	DIA-019-36-2
	3/16"	48"	50'	1.40	DIA-019-48-2
	1/4"	48"	50'	1.88	DIA-025-48-2

Cut Charge : Plus 15%, Cut strips will be priced on a per item basis. Please call for pricing.
Product Information : Suffix on part number indicates the number of plies. -1 = 1 ply. -2 = 2 ply.

MATTING

MATTING

Colour : BLACK

Description	Weight (lbs)	Part #
ANTI-FATIGUE INTERLOCK MATT 3'X3'	17.00	MATIN-3B
RED O/R INTERLOCK MAT 3'X3'	17.00	MATIN-3R
1/8"NARROW RIB MAT 36"X75'	0.83	MATN-013-36
1/8"WIDE RIB MAT 36"X75'	0.83	MATW-013-36
1/8"WIDE RIB MAT 48"X75'	0.83	MATW-013-48

Air and General Purpose Hose

Water Suction and Discharge Hose

Petroleum, Steam and Chemical Hose

Rubber Material Handling Hose

Plastic Material Handling Hose

Food Hose

Ducting

Auto Truck and Marine Hose

Fire Hose

Welding and Other Hose

Cam and Groove

Nipples, Menders and Shank Fittings

Clamps

High Pressure Fittings

Mine Fittings

Air Fittings

Valves

Sandblast

Fire Fittings

Pipe Fittings

Sheet Rubber

Index and Technical Information

REGULAR RED SHEET

General Characteristics : Low grade packing material
Durometer Shore A : 80
Colour : RED
Elongation % : 250
Tensile PSI : 500
Temperature : -20C to +75C(-4F to +170F)

Thickness	Width	Roll Length	Weight (lbs)	Part #
1/16"	36"	100'	0.60	RED80-006-36
1/16"	48"	100'	0.60	RED80-006-48
3/32"	48"	66'	0.90	RED80-010-48
1/8"	36"	50'	1.20	RED80-013-36
1/8"	48"	66'	1.20	RED80-013-48
3/16"	36"	50'	1.80	RED80-019-36
3/16"	48"	66'	1.80	RED80-019-48
1/4"	36"	50'	2.40	RED80-025-36
1/4"	48"	50'	2.40	RED80-025-48

Cut Charge : Plus 15%, Cut strips will be priced on a per item basis. Please call for pricing.

CLOTH IMPRESSION RED SHEET

PREMIUM CLOTH IMPRESSION RED SHEET

General Characteristics : Low grade packing material with cloth impression one side
Durometer Shore A : 80
Colour : RED
Elongation % : 250
Tensile PSI : 500
Temperature : -20C to +75C(-4F to +175F)

Thickness	Width	Roll Length	Weight (lbs)	Part #
1/16"	48"	100'	0.60	REDCP80-006-48
3/32"	48"	66'	0.90	REDCP80-010-48
1/8"	36"	50'	1.20	REDCP80-013-36
1/8"	48"	66'	1.20	REDCP80-013-48
3/16"	36"	66'	1.80	REDCP80-019-36
3/16"	48"	66'	1.80	REDCP80-019-48
1/4"	36"	50'	2.40	REDCP80-025-36
1/4"	48"	50'	2.40	REDCP80-025-48

Cut Charge : Plus 15%, Cut strips will be priced on a per item basis. Please call for pricing.

SBR

General : Good general purpose sheet

Characteristics

Durometer Shore A : 60/70/80

Colour : BLACK

Elongation % : 250

Tensile PSI : 500

Temperature : -20C to +75C(-4F to +170F)

	Thickness	Width	Roll Length	Weight (lbs)	Part #
	1/32"	48"	100'	0.25	SB60-003-48
Plastic Material Handling Hose	1/16"	48"	100'	0.50	SB60-006-48
	3/32"	48"	66'	0.75	SB60-010-48
Food Hose	1/8"	48"	66'	1.00	SB60-013-48
Ducting	3/16"	48"	66'	1.50	SB60-019-48
	1/4"	48"	50'	2.00	SB60-025-48
Auto Truck and Marine Hose	3/8"	48"	50'	3.00	SB60-038-48
	1/2"	48"	50'	4.00	SB60-050-48
Fire Hose	5/8"	48"	50'	5.00	SB60-063-48
	3/4"	48"	50'	6.00	SB60-075-48
Welding and Other Hose	1"	48"	50'	8.00	SB60-100-48
	1-1/2"	48"	9'	12.00	SB60-150-48
Cam and Groove	2"	48"	9'	16.00	SB60-200-48
	1/2"	48"	50'	4.20	SB80-050-36
Nipples Menders and Shank Fittings	1/2"	48"	50'	4.20	SB80-050-48
	3/4"	48"	50'	6.30	SB80-075-48
Clamps	1"	48"	50'	8.40	SB80-100-48
	1-1/2"	48"	9'	12.60	SB80-150-48
High Pressure Fittings	2"	48"	9'	16.80	SB80-200-48

Cut Charge : Plus 15%, Cut strips will be priced on a per item basis. Please call for pricing.

REGULAR SILICONE

General Characteristics : Excellent heat resistance. Poor abrasion and fuel resistance

Durometer Shore A : 60

Colour : RED

Elongation % : 300

Tensile PSI : 1000

Temperature : -45C to +200C(-50F to +400F)

Thickness	Width	Roll Length	Weight (lbs)	Part #
1/16"	36"	50'	0.51	SIL60-006-36
1/16"	48"	50'	0.51	SIL60-006-48
1/8"	36"	50'	1.02	SIL60-013-36
1/8"	48"	50'	1.02	SIL60-013-48
3/16"	48"	50'	1.53	SIL60-019-36
3/16"	48"	50'	1.53	SIL60-019-48
1/4"	48"	50'	2.04	SIL60-025-48

Cut Charge : Plus 15%, Cut strips will be priced on a per item basis. Please call for pricing.

Air and General Purpose Hose

Water Suction and Discharge Hose

Petroleum, Steam and Chemical Hose

Rubber Material Handling Hose

Plastic Material Handling Hose

Food Hose

Ducting

Auto Truck and Marine Hose

Fire Hose

Welding and Other Hose

Cam and Groove

Nipples, Menders and Shank Fittings

Clamps

High Pressure Fittings

Mine Fittings

Air Fittings

Valves

Sandblast

Fire Fittings

Pipe Fittings

Sheet Rubber

Index and Technical Information

SBR SKIRTBOARD

General : Skirtboard
Characteristics
Durometer Shore A : 55
Colour : BLACK
Elongation % : 250
Tensile PSI : 500
Temperature : -20C to +75C(-4F to +170F)

	Thickness	Width	Roll Length	Weight (lbs)	Part #
	1/4"	4"	50'	0.67	SK-025-4
Plastic Material Handling Hose	1/4"	5"	50'	0.83	SK-025-5
	1/4"	6"	50'	1.00	SK-025-6
Food Hose	1/4"	8"	50'	1.33	SK-025-8
Ducting	1/4"	12"	50'	2.00	SK-025-12
	3/8"	4"	50'	1.00	SK-038-4
Auto Truck and Marine Hose	3/8"	6"	50'	1.50	SK-038-6
	3/8"	8"	50'	1.60	SK-038-8
Fire Hose	3/8"	12"	50'	3.00	SK-038-12
Welding and Other Hose	1/2"	4"	50'	1.33	SK-050-4
	1/2"	5"	50'	1.66	SK-050-5
Cam and Groove	1/2"	6"	50'	2.00	SK-050-6
	1/2"	7"	50'	2.50	SK-050-7
Nipples Menders and Shank Fittings	1/2"	8"	50'	3.00	SK-050-8
	1/2"	10"	50'	3.50	SK-050-10
	1/2"	12"	50'	4.00	SK-050-12
Clamps	3/4"	4"	50'	2.00	SK-075-4
	3/4"	6"	50'	3.00	SK-075-6
High Pressure Fittings	3/4"	7"	50'	6.00	SK-075-7
	3/4"	8"	50'	3.50	SK-075-8
Mine Fittings	3/4"	12"	50'	6.00	SK-075-12
Air Fittings	1"	4"	50'	3.50	SK-100-4
Valves	1"	6"	50'	4.00	SK-100-6
Sandblast	1"	8"	50'	5.00	SK-100-8

Cut Charge : Plus 15%, Cut strips will be priced on a per item basis. Please call for pricing.

VITON

General Characteristics : Excellent fuel resistance at elevated temperatures

Durometer Shore A : 75

Colour : BLACK

Elongation % : 200

Tensile PSI : 900

Temperature : -20C to +240C(-4F to +464F)

Thickness	Width	Roll Length	Weight (lbs)	Part #
1/32"	48"	100'	0.34	VI75-003-48
1/16"	48"	100'	0.68	VI75-006-48
3/32"	48"	100'	1.02	VI75-010-48
1/8"	48"	50'	1.36	VI75-013-48
3/16"	48"	50'	2.04	VI75-019-48
1/4"	48"	50'	2.72	VI75-025-48
3/8"	48"	50'	4.08	VI75-038-48

Cut Charge : Cut to length, to the nearest foot, by full width. No cut charge applies to Viton

Air and General Purpose Hose

Water Suction and Discharge Hose

Petroleum, Steam and Chemical Hose

Rubber Material Handling Hose

Plastic Material Handling Hose

Food Hose

Ducting

Auto Truck and Marine Hose

Fire Hose

Welding and Other Hose

Cam and Groove

Nipples, Menders and Shank Fittings

Clamps

High Pressure Fittings

Mine Fittings

Air Fittings

Valves

Sandblast

Fire Fittings

Pipe Fittings

Sheet Rubber

Index and Technical Information

Index For Hose By Working Pressure (PSI)

4500

3/8" BLUE 4500 PRESSURE WASHER..... 129

3000

3/8" BLUE PRESSURE WASHER SMOOTH..... 129
 3/8" BLACK PRESSURE WASHER WRAPPED..... 129

1000

1/2"X50 STEELFLEX AIR..... 22
 1/2"X100 STEELFLEX AIR.....22
 2-1/2" WIRE CONCRETE PLACEMENT.....86
 3"WIRE CONCRETE PLACEMENT.....86

800

3/4"X50 STEELFLEX AIR..... 22
 3/4"X100 STEELFLEX AIR.....22
 1"X50 STEELFLEX AIR..... 22
 1"X100 STEELFLEX AIR.....22
 1-1/2" CONCRETE PLACEMENT..... 85
 2" CONCRETE PLACEMENT..... 85
 2-1/2" CONCRETE PLACEMENT..... 85
 4"WIRE CONCRETE PLACEMENT.....86

750

1/4" NYLON PAINT 750WP..... 130
 3/8" NYLON PAINT 750WP.....130
 1/2" NYLON PAINT 750WP..... 130

700

5" WIRE CONCRETE PLACEMENT.....86

600

1-1/4"X50 STEELFLEX AIR..... 22
 1-1/4"X100 STEELFLEX AIR.....22
 1-1/2"X50 STEELFLEX AIR..... 22
 1-1/2"X100 STEELFLEX AIR.....22
 2"X50 STEELFLEX AIR.....22
 2"X100 STEELFLEX AIR.....22
 3" CONCRETE PLACEMENT..... 85

550

4" CONCRETE PLACEMENT..... 85

500

2-1/2" STEELFLEX AIR.....22
 3" X 50' STEELFLEX AIR.....22
 3" X 100' Steelflex Air..... 22

400

1/2"X50' CONTRACTORS 400 AIR..... 19
 1/2"X100'CONTRACTORS 400 AIR.....19
 3/4"X50' CONTRACTORS 400 AIR..... 19
 3/4"X100'CONTRACTORS 400 AIR.....19
 1"X50' CONTRACTORS 400 AIR..... 19
 1"X100'CONTRACTORS 400 AIR.....19
 1/2"X50'SUPER SERV AIR..... 21
 1/2"X100'SUPER SERV AIR..... 21
 3/4"X50'SUPER SERV AIR..... 21
 3/4"X100'SUPER SERV AIR..... 21
 1"X50'SUPER SERV AIR..... 21
 1"X100'SUPER SERV AIR..... 21

1-1/4"X50'SUPER SERV AIR..... 21
 1-1/4"X100'SUPER SERV AIR..... 21
 1-1/2"X50'SUPER SERV AIR..... 21
 1-1/2"X100'SUPER SERV AIR..... 21
 2"X50'SUPER SERV AIR..... 21
 2"X100'SUPER SERV AIR..... 21
 2-1/2" SUPER SERV AIR..... 21
 3" SUPER SERV AIR..... 21
 4" SUPER SERV AIR..... 21
 4" STEELFLEX AIR.....22
 1/2" MONTANA AIR.....23
 3/4" MONTANA AIR.....23
 1" MONTANA AIR.....23
 1-1/4" MONTANA AIR.....23
 1-1/2" MONTANA AIR.....23
 2" MONTANA AIR.....23
 1/2" SUPER GREEN ORS AIR..... 24
 3/4" SUPER GREEN ORS AIR..... 24
 1" SUPER GREEN ORS AIR..... 24
 1-1/4" SUPER GREEN ORS AIR..... 24
 1-1/2" SUPER GREEN ORS AIR..... 24
 2" SUPER GREEN ORS AIR..... 24

300

3/4"X300' JACKHAMMER YELLOW..... 19
 3/4"X50' JACKHAMMER YELLOW..... 19
 1/2"X50' CONTRACTORS AIR.....20
 1/2"X100'CONTRACTORS AIR.....20
 3/4"X50'CONTRACTORS AIR.....20
 3/4"X100'CONTRACTORS AIR.....20
 1"X50' CONTRACTORS AIR.....20
 1"X100'CONTRACTORS AIR.....20
 1-1/4"X50'CONTRACTORS AIR.....20
 1-1/4"X100'CONTRACTORS AIR.....20
 1-1/2"X50'CONTRACTORS AIR.....20
 1-1/2"X100'CONTRACTORS AIR.....20
 2"X50'CONTRACTORS AIR.....20
 2"X100'CONTRACTORS AIR.....20
 3/4"YELLOW OROFLEX 20..... 23
 1"YELLOW OROFLEX 20..... 23
 1/4"X300 PSI PREM GEN PURP..... 29
 3/8"X300 PSI PREM GEN PURP..... 29
 1/2"X300 PSI PREM GEN PURP..... 29
 3/4"X300 PSI PREM GEN PURP..... 29
 1"X300 PSI PREM GEN PURP..... 29
 1/2" ARCTIC GENERAL PURPOSE..... 29
 3/4" ARCTIC GENERAL PURPOSE..... 29
 1" ARCTIC GENERAL PURPOSE..... 29
 1-1/4" ARCTIC GENERAL PURPOSE..... 29
 1-1/2" ARCTIC GENERAL PURPOSE..... 29
 2" ARCTIC GENERAL PURPOSE..... 29
 3/4" PUSH-ON BLUE 300 PSI..... 30
 3/4" PUSH-ON RED 300 PSI..... 31
 3/4"X300PSI SPECIAL CONTR WATER..... 38
 3/4" SAE 100R4 HYDRAULIC SUCTION..... 55

250

2-1/2" CONTRACTORS AIR.....20
 3" CONTRACTORS AIR.....20
 4" CONTRACTORS AIR.....20
 3/16" X 300' CLEAR REINF PVC..... 25
 1/4" X 300' CLEAR REINF PVC..... 25
 1/4" X 100' CLEAR REINF PVC..... 25
 5/16" X 300' CLEAR REINF PVC..... 25
 3/8" X 300' CLEAR REINF PVC..... 25
 3/8" X 100' CLEAR REINF PVC..... 25
 3/16" X 300' REINFORCED CLEAR PVC..... 26
 1/4" X 300' REINFORCED CLEAR PVC..... 26
 5/16" X 300' REINFORCED CLEAR PVC..... 26
 3/8" X 300' REINFORCED CLEAR PVC..... 26
 1/4"X250PSI GEN PURPOSE..... 27
 3/8"X250PSI GEN PURPOSE..... 27
 1/2"X250PSI GEN PURPOSE..... 27
 3/4"X250PSI GEN PURPOSE..... 27

Index For Hose By Working Pressure (PSI)

175

2-1/2" OROFLEX 10.....	37
3" OROFLEX 10.....	37
1/4" PAINT SPRAY LOW PRESSURE.....	129
3/8" PAINT SPRAY LOW PRESSURE.....	129
1/2" PAINT SPRAY LOW PRESSURE.....	129

150

3"YELLOW OROFLEX 20.....	23
4"YELLOW OROFLEX 20.....	23
3/4" X 300' CLEAR REINF PVC.....	25
3/4"X 100' CLEAR REINF PVC.....	25
3/4" X 300' REINFORCED CLEAR PVC.....	26
1-1/4"X150PSI GEN PURPOSE.....	27
1-1/2"X150PSI GEN PURPOSE.....	27
2"X150PSI GEN PURPOSE.....	27
3/8"x150PSI EPDM GEN PURPOSE.....	28
1-1/4"x150PSI EPDM GEN PURPOSE.....	28
1-1/2"x150PSI EPDM GEN PURPOSE.....	28
2"x150PSI EPDM GEN PURPOSE.....	28
1/2" X 12.5' SELF-STOR ASSY.....	33
1/2" X 25' SELF-STOR ASSY.....	33
1/2" X 50' SELF-STOR ASSY.....	33
1/2" X 75' SELF-STOR ASSY.....	33
1/2" X 100' SELF-STOR ASSY.....	33
1/2" SELF-STOR AIR.....	33
1/2" SELF-STOR MALE SWIVEL.....	33
3/4" BLUE LAYFLAT.....	35
1" BLUE LAYFLAT.....	35
4" OROFLEX 10.....	37
6" OROFLEX 10.....	37
8" OROFLEX 10.....	37
3" DURAFLEX BLACK.....	38
3/4"X150PSI CONTR WATER.....	38
1"X150PSI CONTR WATER.....	38
1-1/4" H.D. GREEN WATER DISCH.....	41
1-1/2" H.D. GREEN WATER DISCH.....	41
2" H.D. GREEN WATER DISCH.....	41
2-1/2" H.D. GREEN WATER DISCH.....	41
1/2" SUPREME WHITE SANITARY.....	41
3/4" SUPREME WHITE SANITARY.....	41
1" SUPREME WHITE SANITARY.....	41
1-1/4" H.P.CONTR WATER.....	42
1-1/2"H.P. CONTR WATER.....	42
2 H.P. CONTR WATER YELLOW STR.....	42
2-1/2" H.P.CONTR WATER.....	42
3"H.P. CONTR WATER YELLOW STR.....	42
4"H.P. CONTR WATER YELLOW STR.....	42
6"H.P. CONTR WATER YELLOW STR.....	42
8" H.P.CONTR WATER.....	42
10" H.P.CONTR WATER.....	42
1" RUBBER WATER SUCTION.....	47
1-1/4" RUBBER WATER SUCT.....	47
1-1/2" RUBBER WATER SUCTION.....	47
2"RUBBER WATER SUCTION.....	47
2-1/2" RUBBER WATER SUCT.....	47
3" RUBBER WATER SUCTION.....	47
3/4" TANK TRUCK BLUE STRIPE.....	49
1" TANK TRUCK BLUE STRIPE.....	49
1-1/4" TANK TRUCK BLUE STRIPE.....	49
1-1/2" TANK TRUCK BLUE STRIPE.....	49
1-3/4" TANK TRUCK.....	49
2" TANK TRUCK BLUE STRIPE.....	49
2-1/2" TANK TRUCK BLUE STRIPE.....	49
3" TANK TRUCK BLUE STRIPE.....	49
4" TANK TRUCK BLUE STRIPE.....	49
6" TANK TRUCK BLUE STRIPE.....	49
1-1/2" ARCTIC DROP HOSE.....	50
2" ARCTIC DROP HOSE.....	50
2-1/2" ARCTIC DROP HOSE.....	50
3" ARCTIC DROP HOSE.....	50
4" ARCTIC DROP HOSE.....	50
6" ARCTIC DROP HOSE.....	50
3" HOT TAR & ASPHALT.....	51
4" HOT TAR & ASPHALT.....	51

2" H.O.T TANK TRUCK DROP 250 F.....	51
2-1/2" H.O.T TANK TRUCK DROP 250 F.....	51
3" H.O.T TANK TRUCK DROP 250F.....	51
4" H.O.T TANK TRUCK DROP 250F.....	51
2" TANK TRUCK DROP 150.....	53
2-1/2" TANK TRUCK DROP 150.....	53
3" TANK TRUCK DROP 150.....	53
4" TANK TRUCK DROP 150.....	53
6" TANK TRUCK DROP 150.....	53
1-1/4" PETROLEUM DISCH.....	53
1-1/2" PETROLEUM DISCH.....	53
2" PETROLEUM DISCHARGE.....	53
2-1/2" PETROLEUM DISCH.....	53
3" PETROLEUM DISCHARGE.....	53
4" PETROLEUM DISCHARGE.....	53
3" PETROLEUM DISCHARGE.....	53
1-1/2" SAE 100R4 HYDRAULIC SUCTION.....	55
1" EPR ACID DISCHARGE.....	59
1-1/2" EPR ACID DISCHARGE.....	59
2" EPR ACID DISCHARGE.....	59
2-1/2" EPR ACID DISCHARGE.....	59
3" EPR ACID DISCHARGE.....	59
1" EPR ACID SUCTION.....	59
1-1/2" EPR ACID SUCTION.....	59
2" EPR ACID SUCTION.....	59
3" EPR ACID SUCTION.....	59
4" EPR ACID SUCTION.....	59
3/4" HYPALON ACID DISCHARGE.....	60
1" HYPALON ACID DISCHARGE.....	60
1-1/2" HYPALON ACID DISCHARGE.....	60
2" HYPALON ACID DISCHARGE.....	60
3" HYPALON ACID DISCHARGE.....	60
4" HYPALON ACID DISCHARGE.....	60
1" HYPALON ACID SUCTION.....	60
1-1/2" HYPALON ACID SUCTION.....	60
2" HYPALON ACID SUCTION.....	60
3" HYPALON ACID SUCTION.....	60
1/2" VITON LINED DISCHARGE.....	61
3/4" VITON LINED DISCHARGE.....	61
1" VITON LINED DISCHARGE.....	61
1-1/2" VITON LINED DISCHARGE.....	61
2" VITON LINED DISCHARGE.....	61
3" VITON LINED DISCHARGE.....	61
3/4" VITON LINED SUCTION.....	61
1" VITON LINED SUCTION.....	61
1-1/2" VITON LINED SUCTION.....	61
2" VITON LINED SUCTION.....	61
3" VITON LINED SUCTION.....	61
4" FLEXCHEM.....	63
3" Aztec Material Handling.....	81
4" AZTEC MATERIAL HANDLING.....	81
5" AZTEC MATERIAL HANDLING.....	81
6" AZTEC MATERIAL HANDLING.....	81
8" aztec material handling.....	81
10" Aztec Material Handling.....	81
12" Aztec Material Handling.....	81
1-1/4" GUNITE.....	82
1-1/2" GUNITE.....	82
1-3/4" GUNITE.....	82
2" GUNITE.....	82
3" BULKMASTER HARDWALL.....	83
1/2"X1-3/16X50' SANDBLAST.....	84
1/2"X1-3/16X100' SANDBLAST.....	84
1/2"X1-1/8" X50'SANDBLAST.....	84
1/2"X1-1/8X100' SANDBLAST.....	84
1/2"X27MMX50' SANDBLAST.....	84
1/2"X27MM X100' SANDBLAST.....	84
3/4"X1-1/2"X50' SANDBLAST.....	84
3/4"X1-1/2"X100' SANDBLAST.....	84
1"X1-1-7/8"X50' SANDBLAST.....	84
1"X1-1-7/8"X100' SANDBLAST.....	84
1"X1-1/2"X50' SANDBLAST.....	84
1"X1-1/2"X100' SANDBLAST.....	84
1-1/4"X2-5/32"X50'SANDBLAST.....	84
1-1/4"X2-5/32"X100'SANDBLAST.....	84
1-1/4"X1-7/8"X50'SANDBLAST.....	84
1-1/4"X1-7/8"X100'SANDBLAST.....	84
1-1/2"X50' SANDBLAST.....	84
1-1/2"X100' SANDBLAST.....	84

Index For Hose By Working Pressure (PSI)

2"X50' SANDBLAST.....	84
2"X 100' SANDBLAST.....	84
2-1/2" SANDBLAST.....	84
3" SANDBLAST.....	84
1"X1-7/8"X100'4 PLY SANDBLAST.....	84
1-1/4"X2-5/32"X100' 4 Ply Sandblast.....	84
1-1/2"X100' 4 Ply Sandblast.....	84
1-1/2" BREWERS SUCTION.....	98
2" BREWERS SUCTION.....	98
1" RUBBER FOOD SUCT & DISCH.....	100
1-1/2"RUBBER FOOD SUCT & DISCH.....	100
2"RUBBER FOOD SUCT & DISCH.....	100
2-1/2"RUBBER FOOD SUCT & DISCH.....	100
3"RUBBER FOOD SUCT & DISCH.....	100
4" rubber food suct & disc.....	100
1/8x1/4 POLYETHYLENE TUBING.....	100
3/16"X5/16"POLYETHYLENE TUBING.....	100
1-1/4" SUPER WIREVAC.....	103
1-1/2" SUPER WIREVAC.....	103
2" SUPER WIREVAC.....	103
1-1/2" FUEL FILL HARD MARINE.....	121
1-5/8" FUEL FILL HARD MARINE.....	121
1-3/4" FUEL FILL HARD MARINE.....	121
1-7/8" FUEL FILL HARD MARINE.....	121
2" FUEL FILL HARD MARINE.....	121
2-1/8" FUEL FILL HARD MARINE.....	121
2-1/4" FUEL FILL HARD MARINE.....	121
2-3/8" FUEL FILL HARD MARINE.....	121

140

3/4" BREWERS DISCH.....	98
1" BREWERS DISCH.....	98
1-1/4" BREWERS DISCH.....	98
1-1/2" BREWERS DISCH.....	98
2"X4 PLY BREWERS DISCH.....	98
2"X6 PLY BREWERS DISCH.....	98
3" BREWERS DISCHARGE.....	98
.170"X1/4"POLYETHYLENE TUBING.....	100
.170"X1/4X100"POLYETHYLENE TUBING.....	100

130

1-1/4" BLUE LAYFLAT.....	35
1-1/2" BROWN LAYFLAT.....	36

125

1" X 200' CLEAR REINF PVC.....	25
1" X 100' CLEAR REINF PVC.....	25
1" X 200' REINFORCED CLEAR PVC.....	26
3/4" SELF-STOR AIR.....	33
3/4" SELF-STOR MALE SWIVEL.....	33
3" H.D. GREEN WATER DISCH.....	41
4" H.D. GREEN WATER DISCH.....	41
5" H.D. GREEN WATER DISCH.....	41
6" H.D. GREEN WATER DISCH.....	41
8" H.D. GREEN WATER DISCH.....	41
10" H.D. GREEN WATER DISCH.....	41
4" RUBBER WATER SUCTION.....	47
5" RUBBER WATER SUCTION.....	47
6" RUBBER WATER SUCTION.....	47
1/4"X3/8"POLYETHYLENE TUBING.....	100
1/4"X3/8X100"POLYETHYLENE TUBING.....	100

120

1/4"X10'URETHANE SELF STORING ASSY.....	32
1/4"X15'URETHANE SELF STORING ASSY.....	32
1/4"X20'URETHANE SELF STORING ASSY.....	32
1/4"X25'URETHANE SELF STORING ASSY.....	32
1/4"X50'URETHANE SELF STORING ASSY.....	32

115

2" BROWN LAYFLAT.....	36
-----------------------	----

110

1/4" WIREVAC.....	102
3/8" WIREVAC.....	102
3/8" SILICONE COOLANT.....	122
1/2" SILICONE COOLANT.....	122
5/8" SILICONE COOLANT.....	122
3/4" SILICONE COOLANT.....	122
7/8" SILICONE COOLANT.....	122

100

1-1/4" X 100' CLEAR REINF PVC.....	25
1-1/2" X 100' CLEAR REINF PVC.....	25
1-1/4" X 100' REINFORCED CLEAR PVC.....	26
1-1/2" X 100' REINFORCED CLEAR PVC.....	26
3/8"X10'URETHANE SELF STORING ASSY.....	32
3/8"X15'URETHANE SELF STORING ASSY.....	32
3/8"X20'URETHANE SELF STORING ASSY.....	32
3/8"X25'URETHANE SELF STORING ASSY.....	32
3/8"X50'URETHANE SELF STORING ASSY.....	32
1/2"X25'URETHANE SELF STORING ASSY.....	32
1/2"X50'URETHANE SELF STORING ASSY.....	32
2-1/2" BROWN LAYFLAT.....	36
3" BROWN LAYFLAT.....	36
1-1/4" CONTR WATER DISCH.....	39
1-1/2" CONTR WATER DISCH.....	39
2" CONTR WATER DISCH.....	39
1-1/4"CONTR PLUS WATER DISCH YEL STR.....	40
1-1/2"CONTR PLUS WATER DISCH YEL STR.....	40
2"CONTR PLUS WATER DISCH YELLOW STR.....	40
2-1/2"CONTR PLUS WATER DISCH YEL STR.....	40
3"CONTR PLUS WATER DISCH YELLOW STR.....	40
4"CONTR PLUS WATER DISCH YELLOW STR.....	40
6"CONTR PLUS WATER DISCH YELLOW STR.....	40
12" H.D. GREEN WATER DISCH.....	41
3/4" H.D.PVC WATER SUCT.....	46
1" H.D.PVC WATER SUCT.....	46
1-1/4" H.D.PVC WATER SUCT.....	46
1-1/2" H.D.PVC WATER SUCT.....	46
3/4"X100PSI AG GRAVITY FARM TANK SW.....	55
1"X100PSI AG GRAVITY FARM TANK SW.....	55
2" SAE 100R4 HYDRAULIC SUCTION.....	55
1/2" TEXTILE STEAM.....	57
3/4" TEXTILE STEAM.....	57
1" TEXTILE STEAM.....	57
1-1/4" TEXTILE STEAM.....	57
1-1/2" TEXTILE STEAM.....	57
2" TEXTILE STEAM.....	57
4" BULKMASTER HARDWALL.....	83
4"X5/16" TUBE BULKMASTER HARDWALL.....	83
5" BULKMASTER HARDWALL.....	83
3/4" BACCO.....	97
1" BACCO.....	97
1-1/4" BACCO.....	97
1-1/2" BACCO.....	97
2" BACCO.....	97
2-1/2" BACCO.....	97
3" BACCO.....	97
30MM BACCO.....	97
35MM BACCO.....	97
38MM BACCO.....	97
40MM BACCO.....	97
45MM BACCO.....	97
50MM BACCO.....	97
55MM BACCO.....	97
60MM BACCO.....	97
70MM BACCO.....	97
80MM BACCO.....	97
3/4" FOODFLEX PVC SUCT.....	99
1" FOODFLEX PVC SUCT.....	99
1-1/4" FOODFLEX PVC SUCT.....	99
1-1/2" FOODFLEX PVC SUCT.....	99
3/4" CLEARFLEX PVC SUCT.....	99

Index For Hose By Working Pressure (PSI)

1" CLEARFLEX PVC SUCT.....	99
1-1/2" CLEARFLEX PVC SUCT.....	99
2" CLEARFLEX PVC SUCT.....	99
3/8"X1/2"POLYETHYLENE TUBING.....	100
3/8X1/2X100'POLYETHYLENE TUBING.....	100
3" SUPER WIREVAC.....	103

90

4" BROWN LAYFLAT.....	36
2" H.D.PVC WATER SUCT.....	46
3" H.D.IND VACUUM 1/8" RED TUBE.....	86
4" H.D.IND VACUUM 1/8" RED TUBE.....	86
4" H.D.IND VACUUM 1/4" RED TUBE.....	86
4" BACCO.....	97
90MM BACCO.....	97
2" FOODFLEX PVC SUCT.....	99
2-1/2" FOODFLEX PVC SUCT.....	99
3"FOODFLEX PVC SUCT.....	99
1/2" WIREVAC.....	102
5/8" WIREVAC.....	102
1" SILICONE COOLANT.....	122
1-1/16 SILICONE COOLANT.....	122
1-1/8" SILICONE COOLANT.....	122

85

1-1/2" GREEN LAYFLAT.....	36
3/4" SATURN PVC SUCT.....	43
3/4" WHITE HELIX PVC SUCT.....	44
1-1/4" SILICONE COOLANT.....	122
1-5/16" SILICONE COOLANT.....	122
1-3/8" SILICONE COOLANT.....	122

80

2" GREEN LAYFLAT.....	36
1" SATURN PVC SUCT.....	43
1" WHITE HELIX PVC SUCT.....	44
2-1/2" H.D.PVC WATER SUCT.....	46
4" FOODFLEX PVC SUCT.....	99
1-1/2" SILICONE COOLANT.....	122
1-5/8" SILICONE COOLANT.....	122
1-3/4" SILICONE COOLANT.....	122
1-7/8" SILICONE COOLANT.....	122

75

2" X 100' CLEAR REINF PVC.....	25
2" X 100' REINFORCED CLEAR PVC.....	26
3" GREEN LAYFLAT.....	36
4" GREEN LAYFLAT.....	36
2-1/2" CONTR WATER DISCH.....	39
3" CONTR WATER DISCH.....	39
4" CONTR WATER DISCH.....	39
6" CONTR WATER DISCH.....	39
8"CONTR PLUS WATER DISCH YELLOW STR.....	40
10"CONTR PLUS WATER DISC YELLOW STR.....	40
12"CONTR PLUS WATER DISC YELLOW STR.....	40
3" H.D.PVC WATER SUCT.....	46
2" TANK TRUCK DROP.....	52
2-1/2" TANK TRUCK DROP.....	52
3" TANK TRUCK DROP.....	52
4" TANK TRUCK DROP.....	52
3"BULKMASTER SOFT 3/16 TUBE.....	83
4"BULKMASTER SOFT 1/8" TUBE.....	83
4"BULKMASTER SOFT 3/16" TUBE.....	83
4"BULKMASTER SOFT 1/4" TUBE.....	83
4"BULKMASTER SOFT 3/8" TUBE.....	83
4-1/2"BULKMASTER SOFT 1/8" TUBE.....	83
5"BULKMASTER SOFT 1/8" TUBE.....	83
5"BULKMASTER SOFT 3/16" TUBE.....	83
5"BULKMASTER SOFT 1/4" TUBE.....	83
5"X5/16" TUBE BULKMASTER SOFTWALL.....	83
6"BULKMASTER SOFT 3/16" TUBE.....	83

6"BULKMASTER SOFT 1/4" TUBE.....	83
5" BACCO.....	97
1/2 x 5/8 POLYETHYLENE TUBING.....	100
1/2x5/8X100'POLYETHYLENE TUBING.....	100
3/4" WIREVAC.....	102
1" WIREVAC.....	102
3/16" FUEL LINE.....	121
2" SILICONE COOLANT.....	122
2-1/8" SILICONE COOLANT.....	122
1/4" SILICONE HEATER BULK.....	123

70

1-1/2" BLUE LAYFLAT.....	35
6" BROWN LAYFLAT.....	36
1-1/4" SATURN PVC SUCT.....	43
1-1/4" WHITE HELIX PVC SUCT.....	44
2" ARI SUCTION.....	89
2-1/2" ARI SUCTION.....	89

65

2" BLUE LAYFLAT.....	35
2-1/2" BLUE LAYFLAT.....	35
1-1/2" SATURN PVC SUCT.....	43
1-1/2" WHITE HELIX PVC SUCT.....	44
3" 5000 SERIES DROP HOSE.....	52
4" 5000 SERIES DROP HOSE.....	52
2-1/2" SAE 100R4 HYDRAULIC SUCTION.....	55
2" TAN BULKMASTER.....	85
2-1/2" TAN BULKMASTER.....	85
3" TAN BULKMASTER.....	85
1/8"X1/4"CLEAR VINYL TUBING.....	101
2-1/4" SILICONE COOLANT.....	122
2-3/8" SILICONE COOLANT.....	122
2-1/2" SILICONE COOLANT.....	122
5/16" SILICONE HEATER BULK.....	123
3/8" SILICONE HEATER BULK.....	123
1/2" SILICONE HEATER BULK.....	123
5/8" SILICONE HEATER BULK.....	123

60

3" BLUE LAYFLAT.....	35
4" BLUE LAYFLAT.....	35
8" BROWN LAYFLAT.....	36
6" GREEN LAYFLAT.....	36
2" SATURN PVC SUCT.....	43
2-1/2" SATURN PVC SUCT.....	43
3" SATURN PVC SUCT.....	43
2" WHITE HELIX PVC SUCT.....	44
2-1/2" WHITE HELIX PVC SUCT.....	44
3" WHITE HELIX PVC SUCT.....	44
1-1/2" EPDM WATER SUCT GREEN HELIX.....	45
2" EPDM WATER SUCT.....	45
4" H.D.PVC WATER SUCT.....	46
6" H.D. IND VACUUM 1/8" RED TUBE.....	86
6" H.D.IND VACUUM 1/4" RED TUBE.....	86
3" ARI SUCTION.....	89
4" ARI SUCTION.....	89
5" ARI SUCTION.....	89
6" ARI SUCTION.....	89
1-1/2" NEPTUNE PVC SUCT.....	93
2" NEPTUNE PVC SUCT.....	93
57MM NEPTUNE PVC SUCT.....	93
1-1/2" NEPTUNE STATIC PVC SUCT.....	94
2" NEPTUNE STATIC PVC SUCT.....	94
57MM NEPTUNE STATIC PVC SUCT.....	94
1-1/4" WIREVAC.....	102
1-1/2" WIREVAC.....	102
2" WIREVAC.....	102
2-5/8" SILICONE COOLANT.....	122
1/2" AUTO HEATER.....	123
5/8" AUTO HEATER.....	123

Index For Hose By Working Pressure (PSI)

55

5" H.D.PVC WATER SUCT.....	46
3" SAE 100R4 HYDRAULIC SUCTION.....	55
2-1/2" NEPTUNE PVC SUCT.....	93
2-1/2" NEPTUNE STATIC PVC SUCT.....	94
3/16"X5/16"CLEAR VINYL TUBING.....	101
1/4"X3/8"CLEAR VINYL TUBING.....	101
3/8"X 5/8" CLEAR VINYL TUBING.....	101

50

3" HOT AIR BLOWER.....	24
4" HOT AIR BLOWER.....	24
4" SATURN PVC SUCT.....	43
4" WHITE HELIX PVC SUCT.....	44
3" EPDM WATER SUCT GREEN HELIX.....	45
6" H.D.PVC WATER SUCT.....	46
8" RUBBER WATER SUCTION.....	47
10" RUBBER WATER SUCTION.....	47
12" RUBBER WATER SUCTION.....	47
.....	49
4" TAN BULKMASTER.....	85
5" TAN BULKMASTER.....	85
6" TAN BULKMASTER.....	85
8" TAN BULKMASTER.....	85
8" h.d. ind vacuum 1/8" red tube.....	86
8" H.D.IND VACUUM 1/4" RED TUBE.....	86
3" NEPTUNE PVC SUCT.....	93
3" NEPTUNE STATIC PVC SUCT.....	94
5/16"X7/16"CLEAR VINYL TUBING.....	101
1/4" FUEL LINE.....	121
5/16" FUEL LINE.....	121
3/8" FUEL LINE.....	121
2-3/4" SILICONE COOLANT.....	122
3" SILICONE COOLANT.....	122
3/4" SILICONE HEATER BULK.....	123
3/4" AUTO HEATER.....	123
1" AUTO HEATER.....	123

45

5" BLUE LAYFLAT.....	35
4" EPDM WATER SUCT.....	45
8" ARI SUCTION.....	89
1" B-FLEX.....	90
1-1/4" B-FLEX.....	90
1-1/2" B-FLEX.....	90
39MM B-FLEX.....	90
45MM B-FLEX.....	90
1-1/2" B-FLEX STATIC.....	91
39MM B-FLEX STATIC.....	91
45MM B-FLEX STATIC.....	91
3-1/2" NEPTUNE STATIC PVC SUCT.....	94
4" NEPTUNE STATIC PVC SUCT.....	94
1-1/2" PU VAC.....	95
3/8"X1/2"CLEAR VINYL TUBING.....	101
1/2"X 3/4"CLEAR VINYL TUBING.....	101
3" WIREVAC.....	102
1-1/4" SUPER VACUFLEX DUCT.....	106
1" SILICONE HEATER BULK.....	123

41

1-1/4" X 25' NC2 DUCT.....	107
1-1/2" X 25' NC2 DUCT.....	107

40

6" SATURN PVC SUCT.....	43
6" WHITE HELIX PVC SUCT.....	44
1" IND VACUUM.....	87
1-1/4" IND VACUUM.....	87
1-1/2" IND VACUUM.....	87

2" IND VACUUM.....	87
2-1/2" IND VACUUM.....	87
3" IND VACUUM.....	87
3-1/2" INDUSTRIAL VACUUM.....	87
4" IND VACUUM.....	87
4-1/2" INDUSTRIAL VACUUM.....	87
5" IND VACUUM.....	87
6" IND VACUUM.....	87
2" B-FLEX.....	90
2-1/2" B-FLEX.....	90
3" b-flex.....	90
57MM B-FLEX.....	90
2" B-FLEX STATIC.....	91
2-1/2" B-FLEX STATIC.....	91
3" B-FLEX STATIC.....	91
57mm b-flex static.....	91
4" NEPTUNE PVC SUCT.....	93
5" NEPTUNE STATIC PVC SUCT.....	94
2" PU VAC.....	95
2-1/2" PU VAC.....	95
3" PU VAC.....	95
60MM PU VAC.....	95
5/8"X3/4"CLEAR VINYL TUBING.....	101
5/8"X7/8"CLEAR VINYL TUBING.....	101
1"X1-1/2"CLEAR VINYL TUBING.....	101

36

1-1/2" SUPER VACUFLEX DUCT.....	106
---------------------------------	-----

35

6" BLUE LAYFLAT.....	35
8" BLUE LAYFLAT.....	35
10" BLUE LAYFLAT.....	35
6" EPDM WATER SUCT GREEN HELIX.....	45
4" SAE 100R4 HYDRAULIC SUCTION.....	55
3/4"X1"CLEAR VINYL TUBING.....	101
2"X2-1/2"CLEAR VINYL TUBING.....	101
2"DURATHANE MEDIUM DUCT.....	116
3-1/2" SILICONE COOLANT.....	122
4" SILICONE COOLANT.....	122

33

2" X 25' NC2 DUCT.....	107
2"DURATHANE LIGHT DUCT.....	115

32

2-1/2" DURATHANE MEDIUM DUCT.....	116
-----------------------------------	-----

30

12" BLUE LAYFLAT.....	35
8" H.D.PVC WATER SUCT.....	46
3/4" GREY PVC VACUUM.....	92
1" GREY PVC VACUUM.....	92
1-1/4" GREY PVC VACUUM.....	92
5" NEPTUNE PVC SUCT.....	93
6" NEPTUNE.....	93
6" NEPTUNE STATIC PVC SUCT.....	94
4" PU VAC.....	95
1" PU VAC LIGHT.....	96
1-1/4" PU VAC LITE.....	96
1/2"X 5/8"CLEAR VINYL TUBING.....	101
1-1/2"X1-7/8"CLEAR VINYL TUB.....	101
2" X 25' NC1 DUCT.....	106
2-1/2" DURATHANE LIGHT DUCT.....	115
3"DURATHANE MEDIUM DUCT.....	116

28

Index For Hose By Working Pressure (PSI)

2" SUPERFLEX PVC SUCTION.....	45
3" TDHS DUCT.....	108

27

2-1/2" X 25' NC2 DUCT.....	107
3"DURATHANE LIGHT DUCT.....	115

26

3" SUPERFLEX PVC SUCTION.....	45
2" SUPER VACUFLEX DUCT.....	106
1-1/4" X 12' L1 DUCT.....	111
1-1/4" X 12' L9 DUCT.....	113

25

1-1/2" GREY PVC VACUUM.....	92
2" GREY PVC VACUUM.....	92
1-1/2" PU VAC LITE.....	96
2" PU VAC LITE.....	96
1"X1-1/4"CLEAR VINYL TUBING.....	101
2-1/2" X 25' NC1 DUCT.....	106
1-1/2" X 12' L1 DUCT.....	111
1-1/2" X 12' L9 DUCT.....	113
4-1/2" SILICONE COOLANT.....	122
5" SILICONE COOLANT.....	122

24

3" X 25' NC1 DUCT.....	106
3" TDS DUCT.....	108
4" TDHS DUCT.....	108
2" X 12' L1 DUCT.....	111
2" X 12' L9 DUCT.....	113

23

3" X 25' NC2 DUCT.....	107
1-3/4" X 12' L1 DUCT.....	111
1-3/4" X 12' L9 DUCT.....	113

22

1-1/4" VAC-U-LOK DUCT.....	107
----------------------------	-----

21

2-1/4" X 12' L1 DUCT.....	111
2-1/4" X 12' L9 DUCT.....	113
4"DURATHANE MEDIUM DUCT.....	116

20

4" SUPERFLEX PVC SUCTION.....	45
2-1/2" GREY PVC VACUUM.....	92
8" NEPTUNE.....	93
5" PU VAC.....	95
2-1/2" PU VAC LITE.....	96
1-1/4"X1-1/2"CLEAR VINYL TUB.....	101
2-1/2" SUPER VACUFLEX DUCT.....	106
3" SUPER VACUFLEX DUCT.....	106
1-1/2" VAC-U-LOK DUCT.....	107
5" TDHS DUCT.....	108
2-1/2" X 12' L1 DUCT.....	111
2-1/2" X 12' L9 DUCT.....	113
5-1/2" SILICONE COOLANT.....	122
6" SILICONE COOLANT.....	122

19

3" X 12' L1 DUCT.....	111
3" X 12' L9 DUCT.....	113

18

4" X 25' NC1 DUCT.....	106
4" X 25' NC2 DUCT.....	107
4" TDS DUCT.....	108
6" TDHS DUCT.....	108
1-1/4" X 12' U1 DUCT.....	110
1-1/2" X 12' U1 DUCT.....	110
3-1/2" X 12' L1 DUCT.....	111
1-1/2" X 12' U9 DUCT.....	112
3-1/2" X 12' L9 DUCT.....	113
4"DURATHANE LIGHT DUCT.....	115
5"DURATHANE MEDIUM DUCT.....	116

17

2" TPR DUCT.....	105
------------------	-----

16

3/4" TPU DUCT.....	109
1-3/4" X 12' U1 DUCT.....	110
4" X 12' L1 DUCT.....	111
1-3/4" X 12' U9 DUCT.....	112
4" X 12' L9 DUCT.....	113
5"DURATHANE LIGHT DUCT.....	115
6"DURATHANE MEDIUM DUCT.....	116

15

6" SUPERFLEX PVC SUCTION.....	45
3"URETHANE DUST&VAPOUR RECOVERY.....	54
3" GREY PVC VACUUM.....	92
4" GREY PVC VACUUM.....	92
6" PU VAC.....	95
80MM PU VAC.....	95
3" PU VAC LITE.....	96
4" PU VAC LITE.....	96
1" TPU DUCT.....	109
2" X 12' U1 DUCT.....	110
4-1/2" X 12' L1 DUCT.....	111
2" X 12' U9 DUCT.....	112
4-1/2" X 12' L9 DUCT.....	113

14

4" SUPER VACUFLEX DUCT.....	106
5" X 25' NC2 DUCT.....	107
6" X 25' NC2 DUCT.....	107
2" VAC-U-LOK DUCT.....	107
7" TDHS DUCT.....	108
2-1/4" X 12' U1 DUCT.....	110
2-1/2" X 12' U1 DUCT.....	110
5" X 12' L1 DUCT.....	111
2-1/4" X 12' U9 DUCT.....	112
2-1/2" X 12' U9 DUCT.....	112
5" X 12' L9 DUCT.....	113
6"DURATHANE LIGHT DUCT.....	115
7"DURATHANE MEDIUM DUCT.....	116

13

2-1/2" TPR DUCT.....	105
3/4" CMD DUCT.....	106
1-1/4" TPU DUCT.....	109
3" X 12' U1 DUCT.....	110
5-1/2" X 12' L1 DUCT.....	111
3" X 12' U9 DUCT.....	112
5-1/2" X 12' L9 DUCT.....	113
4"BLOWER DUCT POLYESTER+WEAR STRIP.....	114

Index For Hose By Working Pressure (PSI)

12.5

3-1/2" X 12' U1.....	110
3-1/2" X 12' U9 DUCT.....	112

12

5" GREY PVC VACUUM.....	92
6" GREY PVC VACUUM.....	92
5" X 25' NC1 DUCT.....	106
7" X 25' NC2 DUCT.....	107
2-1/2" VAC-U-LOC DUCT.....	107
5" TDS DUCT.....	108
8" TDHS DUCT.....	108
4" X 12' U1 DUCT.....	110
4" X 12' U9 DUCT.....	112
7"DURATHANE LIGHT DUCT.....	115
8"DURATHANE MEDIUM DUCT.....	116

11

8" X 25' NC2 DUCT.....	107
4-1/2" X 12' U1 DUCT.....	110
6" X 12' L1 DUCT.....	111
6-1/2" X 12' L1 DUCT.....	111
4-1/2" X 12' U9 DUCT.....	112
6" X 12' L9 DUCT.....	113
6-1/2" X 12' L9 DUCT.....	113
8"DURATHANE LIGHT DUCT.....	115

10

4"URETHANE DUST&VAPOUR RECOVERY.....	54
8" CLEAR PVC VACUUM.....	92
5" PU VAC LITE.....	96
3" TPR DUCT.....	105
3-1/2" TPR DUCT.....	105
4" TPR DUCT.....	105
1" CMD DUCT.....	106
10" X 25' NC2 DUCT.....	107
6" TDS DUCT.....	108
1-1/2" TPU DUCT.....	109
3/4" TPE DUCT.....	109
1" TPE DUCT.....	109
1-1/4" TPE DUCT.....	109
1-1/2" TPE DUCT.....	109
2" TPE DUCT.....	109
2-1/2" TPE DUCT.....	109
5" X 12' U1 DUCT.....	110
5" X 12' U9 DUCT.....	112
10"DURATHANE MEDIUM DUCT.....	116

9.5

5-1/2" X 12' U1 DUCT.....	110
5-1/2" X 12' U9 DUCT.....	112

9

5" TPR DUCT.....	105
7" X 12' L1 DUCT.....	111
7" X 12' L9 DUCT.....	113
10"DURATHANE LIGHT DUCT.....	115

8

5"URETHANE DUST&VAPOUR RECOVERY.....	54
6" TPR DUCT.....	105
6" X 25' NC1 DUCT.....	106
12" X 25' NC2 DUCT.....	107
3" VAC-U-LOK DUCT.....	107
7" TDS DUCT.....	108
10" TDHS DUCT.....	108

2" TPU DUCT.....	109
6"BLOWER DUCT POLYESTER+WEAR STRIP.....	114
12"DURATHANE MEDIUM DUCT.....	116

7

6"URETHANE DUST&VAPOUR RECOVERY.....	54
6" PU VAC LITE.....	96
7" TPR DUCT.....	105
8" TDS DUCT.....	108
2-1/2" TPU DUCT.....	109
3" TPE DUCT.....	109
6" X 12' U1 DUCT.....	110
6-1/2" X 12' U1 DUCT.....	110
8" X 12' L1 DUCT.....	111
6" X 12' U9 DUCT.....	112
6-1/2" X 12' U9 DUCT.....	112
8" X 12' L9 DUCT.....	113
12"DURATHANE LIGHT DUCT.....	115
14"DURATHANE MEDIUM DUCT.....	116

6

8" TPR DUCT.....	105
8" X 25' NC1 DUCT.....	106
14" X 25' NC2 DUCT.....	107
10" TDS DUCT.....	108
12" TDHS DUCT.....	108
3" TPU DUCT.....	109
4" TPE DUCT.....	109
7" X 12' U1 DUCT.....	110
9" X 12' L1 DUCT.....	111
7" X 12' U9 DUCT.....	112
9" X 12' L9 DUCT.....	113
8"BLOWER DUCT POLYESTER+WEAR STRIP.....	114

5

8" PU VAC LITE.....	96
16" X 25' NC2 DUCT.....	107
12" TDS DUCT.....	108
4" TPU DUCT.....	109
5" TPU DUCT.....	109
5" TPE DUCT.....	109
8" X 12' U1 DUCT.....	110
10" X 12' L1 DUCT.....	111
8" X 12' U9 DUCT.....	112
10" X 12' L9 DUCT.....	113

4.3

9" X 12' U1 DUCT.....	110
9" X 12' U9 DUCT.....	112

4

10" TPR DUCT.....	105
12" TPR DUCT.....	105
10" X 25' NC1 DUCT.....	106
6" TPU DUCT.....	109
6" TPE DUCT.....	109
11" X 12' L1 DUCT.....	111
12" X 12' L1 DUCT.....	111
11" X 12' L9 DUCT.....	113
12" X 12' L9 DUCT.....	113
10"BLOWER DUCT POLYESTER+WEAR STRIP.....	114
14"DURATHANE LIGHT DUCT.....	115

3

12" X 25' NC1 DUCT.....	106
18" X 25' NC2 DUCT.....	107
10" X 12' U1 DUCT.....	110

Index For Hose By Working Pressure (PSI)

10" X 12' U9 DUCT.....	112
12"BLOWER DUCT POLYESTER+WEAR STRIP.....	114
14"BLOWER DUCT POLYESTER+WEAR STRIP.....	114

2.2

11" X 12' U1 DUCT.....	110
11" X 12' U9 DUCT.....	112

2

14" TPR DUCT.....	105
20" X 25' NC2 DUCT.....	107
16"BLOWER DUCT POLYESTER+WEAR STRIP.....	114
18"BLOWER DUCT POLYESTER+WEAR STRIP.....	114
16"DURATHANE LIGHT DUCT.....	115

1.7

12" X 12' U1 DUCT.....	110
12" X 12' U9 DUCT.....	112

1

20"BLOWER DUCT POLYESTER+WEAR STRIP.....	114
24"BLOWER DUCT POLYESTER.....	114

0.36

2" S-LP-10 DUCT.....	117
3" S-LP-10 DUCT.....	117
4" S-LP-10 DUCT.....	117
5" S-LP-10 DUCT.....	117
6" S-LP-10 DUCT.....	117
7" S-LP-10 DUCT.....	117
8" S-LP-10 DUCT.....	117
9" S-LP-10 DUCT.....	117
10" S-LP-10 DUCT.....	117
12" S-LP-10 DUCT.....	117
14" S-LP-10 DUCT.....	117

N/A

1/4"I.D.X1/2"O.D.PURE GUM TUBING.....	101
3/8"I.D.X5/8"O.D.PURE GUM TUBING.....	101
1/2"I.D.X3/4"O.D.PURE GUM TUBING.....	101
5/8"I.D.X7/8"O.D.PURE GUM TUBING.....	101
3/4"I.D.X1"O.D.PURE GUM TUBING.....	101
7/8"I.D.X1-1/16"O.D.PURE GUM TUBING.....	101
7/8"I.D.X1-1/8"O.D.PURE GUM TUBING.....	101
1"I.D.X1-1/4"O.D.PURE GUM TUBING.....	101

Temperature Conversions

Start reading either Celsius or Fahrenheit degrees in the shaded column, then look for the Celsius equivalent in the left column, or the Fahrenheit equivalent in the right column.

C	C or F	F	C	C or F	F	C	C or F	F
-73	-100	-148	5.0	41	105.8	33.3	92	197.6
-68	-90	-130	5.6	42	107.6	33.9	93	199.4
-62	-80	-112	6.1	43	109.4	34.4	94	201.2
-57	-70	-94	6.7	44	111.2	35.0	95	203.0
-51	-60	-76	0.72	45	113.0	35.6	96	204.8
-46	-50	-58	7.8	46	114.8	36.1	97	206.6
-40	-40	-40	8.3	47	116.6	36.7	98	208.4
-34	-30	-22	8.9	48	118.4	37.2	99	210.2
-29	-20	-4	9.4	49	120.2	37.8	100	212.0
-23	-10	14	10.0	50	122.0			
-17.8	0	32	10.6	51	123.8	43	110	230
-17.2	1	33.8	11.1	52	125.6	49	120	248
-16.7	2	35.6	11.7	53	127.4	54	130	266
-16.1	3	37.4	12.2	54	129.2	60	140	284
-15.6	4	39.2	12.8	55	131.0	66	150	302
-15.0	5	41.0	13.3	56	132.8	71	160	320
-14.4	6	42.8	13.9	57	134.6	77	170	338
-13.9	7	44.6	14.4	58	136.4	82	180	356
-13.3	8	46.4	15.0	59	138.2	88	190	374
-12.8	9	48.2	15.6	60	140.0	93	200	392
-12.2	10	50.0	16.1	61	141.8	99	210	410
-11.7	11	51.8	16.7	62	143.6	100	212	413.6
-11.1	12	53.6	17.2	63	145.4	104	220	428
-10.6	13	55.4	17.8	64	147.2	110	230	446
-10.0	14	57.2	18.3	65	149.0	116	240	464
-9.4	15	59.0	18.9	66	150.8	121	250	482
-8.9	16	60.8	19.4	67	152.6	127	260	500
-8.3	17	62.6	20.0	68	154.4	132	270	518
-7.8	18	64.4	20.6	69	156.2	138	280	536
-7.2	19	66.2	21.1	70	158.0	143	290	554
-6.7	20	68.0	21.7	71	159.8	149	300	572
-6.1	21	69.8	22.2	72	161.6	154	310	590
-5.6	22	71.6	22.8	73	163.4	160	320	608
-5.0	23	73.4	23.3	74	165.2	166	320	626
-4.4	24	75.2	23.9	75	167.0	170	338	640
-3.9	25	77.0	24.4	76	168.8	171	340	644
-3.3	26	78.8	25.0	77	170.6	177	350	662
-2.8	27	80.6	25.6	78	172.4	182	360	680
-2.2	28	82.4	26.1	79	174.2	186	366	691
-1.7	29	84.2	26.7	80	176.0	188	370	698
-1.1	30	86.0	27.2	81	177.8	193	380	716
-0.6	31	87.8	27.8	82	179.6	198	388	730
0	32	89.6	28.3	83	181.4	199	390	734
0.6	33	91.4	28.9	84	183.2	204	400	752
1.1	34	93.2	29.4	85	185.0	208	406	763
1.7	35	95.0	30.0	86	186.8	210	410	770
2.2	36	96.8	30.6	87	188.6	216	420	788
2.8	37	98.6	31.1	88	190.4	221	430	806
3.3	38	100.4	31.7	89	192.2	227	440	824
3.9	39	102.2	32.2	90	194.0	232	450	842
4.4	40	104.0	32.8	91	195.8			

Distance Conversions

MM	INCHES		MM	INCHES		MM	INCHES		MM	INCHES	
	FRACTION	DECIMAL		FRACTION	DECIMAL		FRACTION	DECIMAL		FRACTION	DECIMAL
0.3969	1/64	0.0156	6.7469	17/64	0.2656	13.0969	33/64	0.5156	19.4469	49/64	0.7656
0.7938	1/32	0.0312	7.1438	9/32	0.2812	13.4938	17/32	0.5312	19.8438	25/32	0.7812
1.1906	3/64	0.0468	7.5406	19/64	0.2968	13.8906	35/64	0.5468	20.2406	51/64	0.7968
1.5875	1/16	0.0625	7.9375	5/16	0.3125	14.2875	9/16	0.5625	20.2375	13/16	0.8125
1.9844	5/64	0.0781	8.3344	21/64	0.3281	14.6844	37/64	0.5781	21.0344	53/64	0.8281
2.3812	3/32	0.0937	8.7312	11/32	0.3437	15.0812	19/32	0.5937	21.4312	27/32	0.8437
2.7781	7/64	0.1093	9.1281	23/64	0.3593	15.4781	39/64	0.6093	21.8281	55/64	0.8593
3.1750	1/8	0.1250	9.5250	3/8	0.3750	15.8750	5/8	0.6250	22.2250	7/8	0.8750
3.5719	9/64	0.1406	9.9219	25/64	0.3906	16.2719	41/64	0.6406	22.6219	57/64	0.8906
3.9688	5/32	0.1562	10.3188	13/32	0.4062	16.6688	21/32	0.6562	23.0188	29/32	0.9062
4.3656	11/64	0.1718	10.7156	27/64	0.4218	17.0656	43/64	0.6718	23.4156	59/64	0.9218
4.7625	3/16	0.1875	11.1125	7/16	0.4375	17.4625	11/16	0.6875	23.8125	15/16	0.9375
5.1594	13/64	0.2031	11.5094	29/64	0.4531	17.8594	45/64	0.7031	24.2094	61/64	0.9531
5.5562	7/32	0.2187	11.9062	15/32	0.4687	18.2562	23/32	0.7187	24.6062	31/32	0.9687
5.9531	15/64	0.2343	12.3031	31/64	0.4843	18.6531	47/64	0.7343	25.0031	63/64	0.9843
6.3500	1/4	0.2500	12.7000	1/2	0.5000	19.0500	3/4	0.7500	25.4000	1	1.0000

Pressure Conversions

Kilo-Pascals (kPa)	Mega-Pascals (Mpa)	Bar (bar)	Kilograms per Square Centimeter (Kgf/cm 2)	lbs per Square Inch (psi)	lbs per Square Inch (psi)	Kilo-Pascals (kPa)	Mega-Pascals (Mpa)	Bar (bar)	Kilograms per Square Centimeter (Kgf/cm 2)
100	0.1	1.00	1.0	14.50	10	68.9	0.07	0.7	0.70
200	0.2	2.00	2.0	29.00	20	137.9	0.14	1.4	1.41
300	0.3	3.00	3.1	43.50	30	206.8	0.21	2.1	2.11
400	0.4	4.00	4.1	58.00	40	275.8	0.28	2.8	2.81
500	0.5	5.00	5.1	72.50	50	344.7	0.34	3.4	3.52
600	0.6	6.00	6.1	87.00	60	413.7	0.41	4.1	4.22
700	0.7	7.00	7.1	101.50	70	482.6	0.48	4.8	4.92
800	0.8	8.00	8.2	116.00	80	551.6	0.55	5.5	5.63
900	0.9	9.00	9.2	130.50	90	620.5	0.62	6.2	6.33
1000	1.0	10.00	10.2	145.00	100	689.0	0.70	6.9	7.00
2000	2.0	20.00	20.4	290.10	200	1379.0	1.40	13.8	14.10
3000	3.0	30.00	30.6	435.10	300	2068.0	2.10	20.7	21.10
4000	4.0	40.00	40.8	580.20	400	2758.0	2.80	27.6	28.10
5000	5.0	50.00	51.0	725.20	500	3447.0	3.40	34.5	35.20
6000	6.0	60.00	61.2	870.20	600	4137.0	4.10	41.4	42.20
7000	7.0	70.00	71.4	1015.30	700	4826.0	4.80	48.3	49.20
8000	8.0	80.00	81.6	1160.30	800	5516.0	5.50	55.2	56.30
9000	9.0	90.00	91.8	1305.30	900	6205.0	6.20	62.1	63.30
10000	10.0	100.00	102.0	1450.00	1000	6895.0	6.90	68.9	70.30
20000	20.0	200.00	204.0	2901.00	2000	13790.0	13.80	137.9	140.70
30000	30.0	300.00	306.0	4351.00	3000	20684.0	20.70	206.8	211.00
40000	40.0	400.00	408.0	5802.00	4000	27579.0	27.60	275.8	281.30
50000	50.0	500.00	510.0	7252.00	5000	34474.0	34.50	344.7	351.60
60000	60.0	600.00	612.0	8702.00	6000	41369.0	41.40	413.7	421.90
70000	70.0	700.00	714.0	10153.00	7000	48263.0	48.30	482.6	492.30
80000	80.0	800.00	816.0	11603.00	8000	55158.0	55.20	551.6	562.60
90000	90.0	900.00	918.0	13053.00	9000	62053.0	62.10	620.5	632.90
100000	100.0	1000.00	1020.0	14504.00	10000	68948.0	68.90	689.0	703.00
200000	100.0	2000.00	2040.0	29008.00	20000	137895.0	137.90	1379.0	1406.00
300000	300.0	3000.00	3060.0	43511.00	30000	206843.0	206.80	2068.0	2110.00
					40000	275790.0	275.80	2758.0	2813.00

Conversion Table - Feet of Water to Inches of Mercury

Feet of Water	1	2	4	6	8	10	12	14	16	20	22	24	26	28	30	32	34
Inches of Mercury	0.9	1.8	3.5	5.3	7.1	8.8	10.6	12.4	14.1	17.7	19.4	21.2	23.0	24.8	26.5	28.3	30.0

Water Flow Pressure Loss

(PSI Per 100 Feet Of Hose)

Flow of water in U.S. gal. per min.	Flow of water in cu. feet per sec.	Actual Internal Diameter, Inches								
		1/2"	5/8"	3/4"	1"	1 1/4"	1 1/2"	2"	2 1/2"	3"
0.5	0.001	0.4								
1.5	0.003	3.02	1.01	0.42						
2.5	0.005	7.75	2.58	1.08						
5	0.011	27.8	9.27	3.86	0.95	0.32	0.13			
10	0.022	99.5	33.2	13.8	3.38	1.14	0.47	0.12		
15	0.033		71.0	29.6	7.25	2.45	1.01	0.25	0.08	
20	0.044		121.0	50.3	12.4	4.15	1.71	0.42	0.14	
25	0.055			76.5	18.7	6.34	2.60	0.64	0.22	
30	0.066			108.0	26.5	8.96	3.68	0.90	0.30	0.13
35	0.077			142.0	34.8	11.8	4.83	1.18	0.40	0.17
40	0.088				44.7	15.1	6.20	1.52	0.51	0.21
45	0.099				55.0	18.6	7.65	1.87	0.63	0.26
50	0.110				67.5	22.8	9.35	2.28	0.78	0.32
60	0.132				94.3	31.8	13.1	3.19	1.08	0.45
70	0.154				126.0	42.5	17.5	4.25	1.44	0.60
80	0.176					54.6	22.5	5.48	1.86	0.77
90	0.198					67.5	27.8	6.80	2.30	0.95
100	0.223					81.5	33.5	8.19	2.78	1.15
125	0.278					124.0	50.6	12.4	4.20	1.73
150	0.334						72.1	17.6	6.97	2.46
175	0.390						94.5	23.1	7.83	3.23
200	0.446						122.0	29.6	10.1	4.15
225	0.501							36.8	12.5	5.15
250	0.557							44.6	15.2	6.28
275	0.613							53.3	18.1	7.45
300	0.688							62.5	21.2	8.75
325	0.724							72.5	24.6	10.2
350	0.780							83.2	28.2	11.7
375	0.836							94.5	32.1	13.3
400	0.891							107.0	36.2	14.9
450	1.00								44.9	18.6
500	1.11								54.5	22.5
600	1.34								76.5	31.6
700	1.56								102.0	42.1
800	1.78								131.0	53.9
900	2.00									66.8
1000	2.23									81.4
1100	2.45									97.0
1200	2.67									114.0
1300	2.90									132.0
1400	3.12									
1500	3.34									
1600	3.56									
1800	4.01									
2000	4.45									

The pressure loss of liquid flowing through a hose depends on the rate of flow, the hose I.D, the smoothness of the tube, the viscosity of the liquid, and the hose length. This chart shows the relationship between rate of flow, I.D and pressure loss for water at 68F with a viscosity of one centipoise. The pressure is directly proportional to the length of the hose, therefore, the data shown, can be extended by use of proportions.

Steam Temperature - Pressure Conversion Guide

Temperature - Pressure equivalents of saturated steam gauge pressure at sea level

Temperature		Lbs. per Sq. Inch	Temperature		Lbs. per Sq. Inch	Temperature		Lbs. per Sq. Inch
F	C		F	C		F	C	
212	100.0	0.0	286	141.1	39.4	336	168.9	97.1
214	101.1	0.6	287	141.7	40.3	337	169.4	98.7
216	102.2	1.2	288	142.2	41.1	338	170.0	100.2
218	103.3	1.8	289	142.8	42.0	339	170.6	101.8
220	104.4	2.5	290	143.3	42.9	340	171.1	103.3
222	105.6	3.2	291	143.9	43.8	341	171.7	105.0
224	106.7	3.9	292	144.4	44.7	342	172.2	106.5
226	107.8	4.6	293	145.0	45.6	343	172.8	108.2
228	108.9	5.3	294	145.6	46.5	344	173.3	109.8
230	110.0	6.1	295	146.1	47.5	345	173.9	111.5
232	111.1	6.9	296	146.7	48.4	346	174.4	113.1
234	112.2	7.7	297	147.2	49.4	347	175.0	114.8
236	113.3	8.5	298	147.8	50.3	348	175.6	116.5
238	114.4	9.4	299	148.3	51.3	349	176.1	118.2
240	115.6	10.3	300	148.9	52.3	350	176.7	119.9
242	116.7	11.2	301	149.4	53.4	352	177.8	123.5
244	117.8	12.1	302	150.0	54.4	354	178.9	127.1
246	118.9	13.1	303	150.6	55.4	356	180.0	130.8
248	120.0	14.1	304	151.1	56.4	358	181.1	134.5
250	121.1	15.1	305	151.7	57.5	360	182.2	138.3
252	122.2	16.2	306	152.2	58.6	362	183.3	142.3
254	123.3	17.3	307	152.8	59.7	364	184.4	146.2
256	124.4	18.4	308	153.3	60.7	366	185.6	150.3
258	125.6	19.6	309	153.9	61.9	368	186.7	154.4
260	126.7	20.7	310	154.4	63.0	370	187.8	158.7
261	127.2	21.4	311	155.0	64.2	372	188.9	163.0
262	127.8	22.0	312	155.6	65.3	374	190.0	167.4
263	128.3	22.6	313	156.1	66.5	376	191.1	171.9
264	128.9	23.2	314	156.7	67.6	378	192.2	176.4
265	129.4	23.9	315	157.2	68.8	380	193.3	181.1
266	130.0	24.5	316	157.8	70.0	382	194.4	185.8
267	130.6	25.2	317	158.3	71.3	384	195.6	190.6
268	131.1	25.8	318	158.9	72.5	386	196.7	195.6
269	131.7	26.5	319	159.4	73.7	388	197.8	200.6
270	132.2	27.2	320	160.0	75.0	390	198.9	205.7
271	132.8	27.9	321	160.6	76.3	392	200.0	210.9
272	133.3	28.6	322	161.1	77.5	394	201.1	216.2
273	133.9	29.3	323	161.7	78.8	396	202.2	221.5
274	134.4	30.0	324	162.2	80.1	398	203.3	227.0
275	135.0	30.8	325	162.8	81.5	400	204.4	232.6
276	135.6	31.5	326	163.3	82.8	402	205.5	238
277	136.1	32.3	327	163.9	84.2	404	206.7	244
278	136.7	33.0	328	164.4	85.6	406	207.8	250
279	137.2	33.8	329	165.0	87.0	408	208.9	256
280	137.8	34.5	330	165.6	88.4	410	210	262
281	138.3	35.3	331	166.1	89.8	412	211.1	268
282	138.9	36.1	332	166.7	91.2	414	212.2	275
283	139.4	36.9	333	167.2	92.7	416	213.3	281
284	140.0	37.7	334	167.8	94.1	418	214.4	288
285	140.6	38.6	335	168.3	95.6	420	215.6	294

Degrees Celsius = 5/9 (Degrees F -32)

Open-End Flow (GPM)

		Hose Length, feet										Hose Length, feet							
		psi	25	50	75	100	125	150	200			300	psi	25	50	75	100	125	150
1 /2" hose	30	10.4	6.2	5.6	4.8	4.3	3.8	3.3	2.6	1" hose	30	68.0	46.2	37.5	32.0	28.5	25.8	22.0	17.8
	40	12.1	8.5	6.2	5.6	5.0	4.5	3.8	3.2		40	79.0	54.4	44.0	37.5	33.0	30.0	25.8	20.8
	50	13.8	9.4	7.5	6.4	5.6	5.1	4.0	3.5		50	89.0	62.0	49.0	42.0	37.5	34.0	29.0	23.3
	60	15.2	10.4	8.5	7.1	6.2	5.6	4.9	3.8		60	100.0	68.0	54.4	46.2	41.8	37.5	32.0	25.8
	70	16.6	11.2	9.0	7.8	6.8	6.2	5.3	4.2		70	—	74.0	59.0	51.0	45.0	40.8	37.3	28.0
	80	18.0	12.1	9.8	8.5	7.3	6.6	5.6	4.5		80	—	79.0	63.0	54.4	48.0	43.0	37.5	30.0
	90	19.0	13.0	10.4	8.8	7.7	7.1	6.0	4.8		90	—	84.0	68.0	58.0	51.8	46.2	40.0	32.0
	100	20.1	13.8	11.0	9.4	8.5	7.5	6.4	4.9		100	—	89.0	71.0	62.0	54.4	49.0	42.0	34.0
	125	22.8	15.5	12.5	10.5	9.4	8.5	7.2	5.8		125	—	101.0	80.0	68.0	62.0	55.8	47.8	38.0
5/8" hose	30	18.1	12.5	10.3	8.7	7.7	7.0	6.0	4.9	1 1/4" hose	50	—	110.0	85.0	72.0	56.0	58.0	50.0	42.0
	40	21.4	14.8	12.5	10.3	9.0	8.3	7.0	5.7		75	—	130.0	110.0	90.0	80.0	73.0	64.0	52.0
	50	23.9	16.5	13.2	11.4	10.3	9.2	7.9	6.3		100	—	150.0	125.0	110.0	92.0	85.0	73.0	58.0
	60	26.5	18.1	14.8	12.5	11.2	10.3	8.7	7.0		150	—	—	150.0	130.0	120.0	110.0	90.0	67.0
	70	27.5	20.0	16.0	13.7	12.0	11.0	10.0	7.6		50	—	140.0	115.0	96.0	85.0	75.0	65.0	54.0
3/4" hose	80	30.6	21.4	16.8	14.8	13.0	11.8	10.3	8.3	1 3/8" hose	75	—	170.0	140.0	125.0	110.0	96.0	84.0	67.0
	90	32.5	22.5	18.1	15.5	14.0	12.5	10.5	8.7		150	—	—	205.0	170.0	155.0	140.0	125.0	97.0
	100	34.5	23.9	19.0	16.6	14.8	13.2	11.4	9.2		50	—	180.0	150.0	130.0	120.0	105.0	90.0	74.0
	125	39.0	27.0	21.5	18.5	16.6	15.0	12.9	10.5		75	—	230.0	180.0	160.0	145.0	130.0	120.0	90.0
	30	31.0	21.3	17.2	14.8	13.0	11.8	10.2	8.2		1 1/2" hose	100	—	260.0	220.0	180.0	170.0	150.0	130.0
40	36.0	25.0	20.0	17.2	15.2	13.8	11.8	9.4	150	—		—	260.0	230.0	205.0	180.0	160.0	130.0	
50	41.0	28.0	22.5	19.2	17.2	15.5	13.2	10.7	75	—		480.0	380.0	330.0	290.0	270.0	230.0	180.0	
60	45.5	31.0	25.0	21.3	19.0	17.2	14.8	11.8	2" hose	100		—	550.0	450.0	380.0	350.0	310.0	260.0	215.0
70	49.5	34.0	27.2	23.5	21.0	18.8	17.1	12.8		125		—	—	550.0	480.0	425.0	380.0	330.0	265.0
80	53.0	36.0	29.1	25.0	22.0	20.0	17.2	13.8											
90	56.2	39.0	31.0	27.0	23.8	21.3	18.2	14.8											
100	60.0	41.0	33.0	28.0	25.0	22.6	19.2	15.5											
125	68.0	46.0	37.5	32.0	23.0	25.8	21.8	17.5											

Force Chart

Force (In Pounds)

Hose	25	50	75	100	150	200	250	300	500	1000
I.D.	PSI	PSI	PSI	PSI	PSI	PSI	PSI	PSI	PSI	PSI
1/4"	1	2	4	5	7	10	12	15	25	49
3/8"	3	6	8	11	17	22	28	33	55	110
1/2"	5	10	15	20	29	39	49	59	98	196
3/4"	11	22	33	44	66	88	110	133	221	442
1"	20	39	59	79	118	157	196	236	393	785
1-1/4"	31	61	92	123	184	245	307	368	614	1227
1-1/2"	44	88	133	177	265	353	442	530	884	1767
2"	79	157	236	314	471	628	785	942	1571	3142
2-1/2"	123	245	368	491	736	982	1227	1473	2454	4909
3"	177	353	530	707	1060	1414	1767	2121	3534	7069
4"	314	628	942	1257	1885	2513	3142	3770	6283	12566
5"	491	982	1473	1964	2945	3927	4909	5891	9818	19635
6"	707	1414	2121	2827	4241	5655	7069	8482	14137	28274
8"	1257	2513	3770	5027	7540	10053	12566	15080	25133	50266
10"	1964	3927	5891	7854	11781	15708	19635	23562	39270	78540
12"	2827	5655	8482	11310	16965	22620	28274	33929	56549	113098

Flow Data

This table may be used to determine the pressure loss in hose connected to pneumatic tools. Hose with rough tube may have a friction loss as much as 50% greater than the represented figures. The represented figures apply to hose with smooth inner tube.

Air Flow Pressure Loss

PULSATING FLOW

Cubic feet free air per minute passing through 50 foot lengths of hose

Size of Hose	Gauge press. at line	20	30	40	50	60	70	80	90	100	110	120	130	140	150
Loss of pressure in pounds per square inch - 50 foot hose length															
	50	1.8	5.0	10.1	18.1										
1/2 in.	60	1.3	4.0	8.4	14.8	23.4									
with couplings	70	1.0	3.4	7.0	12.4	20.0	28.4								
at each end	80	0.9	2.8	6.0	10.8	17.4	25.2	34.6							
	90	0.8	2.4	5.4	9.5	14.8	22.0	30.5	41.0						
	100	0.7	2.3	4.8	8.4	13.3	19.3	27.2	36.6						
	110	0.6	2.0	4.3	7.6	12.0	17.6	24.6	33.3	44.5					
3/4 in.	50	0.4	0.8	1.5	2.4	3.5	4.4	6.5	8.5	11.4	14.2				
with couplings	60	0.3	0.6	1.2	1.9	2.8	3.8	5.2	6.8	8.6	11.2				
at each end	70	0.2	0.5	0.9	1.5	2.3	3.2	4.2	5.5	7.0	8.8	11.0			
	80	0.2	0.5	0.8	1.3	1.9	2.8	3.6	4.7	5.8	7.2	8.8	10.6		
	90	0.2	0.4	0.7	1.1	1.6	2.3	3.1	4.0	5.0	6.2	7.5	9.0		
	100	0.2	0.4	0.6	1.0	1.4	2.0	2.7	3.5	4.4	5.4	6.6	7.9	9.4	11.1
	110	0.1	0.3	0.5	0.9	1.3	1.8	2.4	3.1	3.9	4.9	5.9	7.1	8.4	9.9
	50	0.1	0.2	0.3	0.5	0.8	1.1	1.5	2.0	2.6	3.5	4.8	7.0		
1 in.	60	0.1	0.2	0.3	0.4	0.6	0.8	1.2	1.5	2.0	2.6	3.3	4.2	5.5	7.2
with couplings	70		0.1	0.2	0.4	0.5	0.7	1.0	1.3	1.6	2.0	2.5	3.1	3.8	4.7
at each end	80		0.1	0.2	0.3	0.5	0.7	0.8	1.1	1.4	1.7	2.0	2.4	2.7	3.5
	90		0.1	0.2	0.3	0.4	0.6	0.7	0.9	1.2	1.4	1.7	2.0	2.4	2.8
	100		0.1	0.2	0.2	0.4	0.5	0.6	0.8	1.0	1.2	1.5	1.8	2.1	2.4
	110		0.1	0.2	0.2	0.3	0.4	0.6	0.7	0.9	1.1	1.3	1.5	1.8	2.1
	50			0.1	0.2	0.2	0.3	0.4	0.5	0.7	1.1				
1 1/4 in.	60				0.1	0.2	0.3	0.3	0.5	0.6	0.8	1.0	1.2	1.5	
with couplings	70				0.1	0.2	0.2	0.3	0.4	0.5	0.7	0.8	1.0	1.3	
at each end	80					0.1	0.2	0.2	0.3	0.4	0.5	0.6	0.7	0.8	1.0
	90						0.1	0.2	0.2	0.3	0.3	0.4	0.5	0.6	0.8
	100							0.1	0.2	0.2	0.3	0.4	0.4	0.5	0.6
	110								0.1	0.2	0.2	0.3	0.3	0.4	0.5
	50							0.1	0.2	0.2	0.2	0.3	0.3	0.4	0.5
1 1/2 in.	60								0.1	0.2	0.2	0.2	0.3	0.3	0.4
with couplings	70									0.1	0.2	0.2	0.2	0.3	0.4
at each end	80										0.1	0.2	0.2	0.2	0.3
	90											0.1	0.2	0.2	0.3
	100												0.1	0.2	0.2
	110													0.1	0.2

For longer or shorter lengths of hose, the friction loss is proportional to the length, e.g., for 25 ft., half of the above; for 150 ft., three times the above, etc.



9555 Henri Bourassa Ouest Ville St Laurent, Quebec H4S 1S7
email: sales@amiflex.com

Téléphone: 514.336.2480
Toll Free: 888.775.4673 (HOSE)
Télécopieur: 888.990.4673 (HOSE)
www.amiflex.com

Distributed By:

The information presented in this brochure is to be used as a general guide. This literature and other literature from Amiflex Inc. is to provide product options for further investigation by experienced, technically versed users. Due to the varietal nature of operating conditions and applications, the user is solely responsible for making the final selection of the product with full understanding that the performance and safety criteria of the application are met. The product specifications presented here are subject to change without notice.